

Naval Facilities Engineering Command

200 Stovall Street
Alexandria, Virginia 22332-2300

APPROVED FOR PUBLIC RELEASE

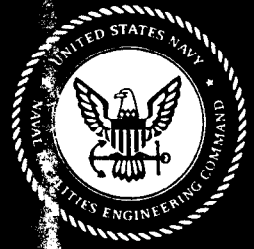

Wood Protection

NAVFAC MO-312

MAY 1990

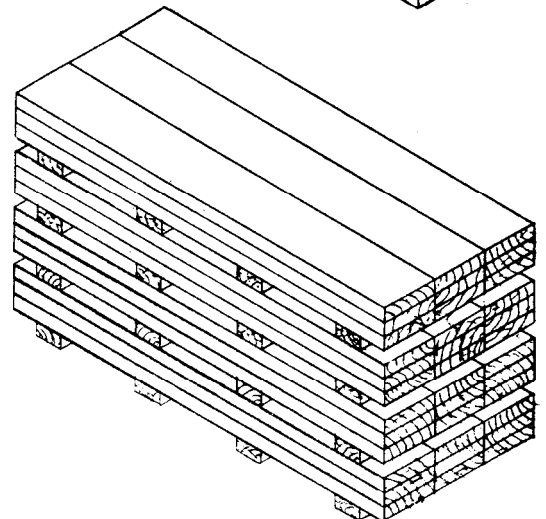
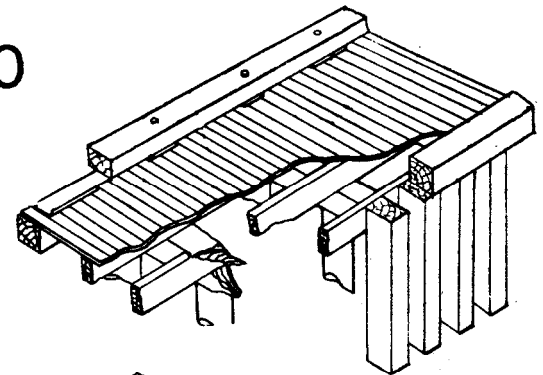
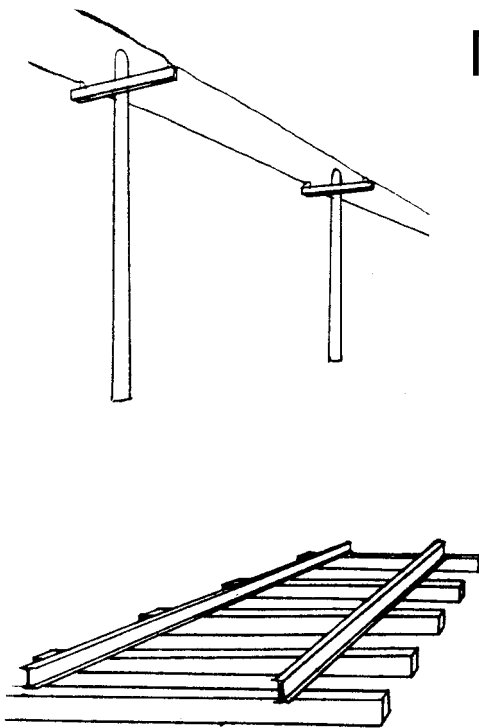

S/N 0525-LP-321-7700

SNDL DISTRIBUTION

A3 CNO

A6 CMC

(25 Copies each):

FKA1C COMNAVFACENGCOM

FKN1 EFDs

(10 Copies each):

FA46 PWCLANT

FKP7 NAVSHIPYDs

FB54 PWCPAC

FT104 PWCCNET

HQ U.S. AIR FORCE
Engineering And Services Center
Tyndall AFB, FL 32403

U.S. ARMY
Office Chief of Engineers
Washington, D.C. 20314 (DAEN•MPO)

(2 Copies each):

23C NAVRESFORDET
26B NAVSRESFORDET
E3A LABONR
E3C NORDA
F47 NAVSTALANT
FA10 SUBASELANT
FA13 NAVSUBSUPPFACLANT
FB10 NAVSTAPAC
FB13 SUBASEPAC
FB28 COMNAVABASEPAC
FB36 NAVFACPAC
FB45 TRIREFFACPAC
FB48 NAVSUPPFACPAC
FC1 FOCCEUR
FC3 COMNAVACTEUR
FC5 NAVSUPACTEUR
FC7 NAVSTAEUR
FC12 NAVSUPPOEUR
FD1 COMNAVOCEANCOM
FD4 OCEANCEN
FF1 COMNAVDIST Washington, DC
FF3 NAVSTACNO
FF18 NAVTACSUPPACT
FF32 FLDSUPPACT
FF38 USNA
FF42 NAVPGSCOL
FH1 COMNAVMECOM
FH3 NAVHOSP
FKA1 SYSCOMHQS

FKN2 CBCs
FKN3 OICCs
FKN7 NEESA
FKN10 NAVSUPPFAC
FKN11 NAVCIVENGLAB
FKP1B WPNSTAs
FKP1J NAVORDSTAs
FKP3A NAVPRO
FKP5A NAVSEACEN
FT1 CNET
FT15 NAVU
FT18 CBU
FT20 NAVCONSTRACEN
FT24 FLETRACEN
FT28 NETC
FT31 NTC
FT37 NAVSCOLCECOFF
FT38 NAVSUBTRACENPAC
FT39 NAVTECHTRACEN
FT55 NAVSCSCOL
FT60 EDTRASUPPCEN
FT78 NAVEDTRAPRODDEVEN
FT85 TRITRAFAC
V2 MARBKS
V12 CGMCDEC
V14 HQBNHQMC
V16 CGMCB (Less Oahu)
V17 MARCORCAMP
V23 CGMCLB

Additional Copies may be obtained from:

Navy Publications and Forms Center
5801 Tabor Avenue
Philadelphia, PA 19120

FOREWORD

The Navy has a multi-billion dollar investment in wooden structures and in utilities. Wood is a readily available, inexpensive natural resource that is both a versatile and useful construction material. The usefulness of wood is increased when it is protected against deteriorating agents by pressure treatment with preservatives. This manual provides information which will help ensure that Navy personnel are able to specify and receive preservative treated wood products most suitable for a particular end use. Specifically this manual covers wood as a construction material, wood identification, wood deterioration, preservation of new wood products, quality control or how to specify and inspect treated wood products, as well as maintenance of treated wood products and remedial control. When information in this manual varies from that contained in the latest issue of Federal or Military Specifications, the Specification(s) shall apply.

Additional information or suggestions that will improve this manual are invited and should be submitted through appropriate channels to the Naval Facilities Engineering Command, (Attention: Code 1634), 200 Stovall Street, Alexandria, VA 22332-2300.

This publication cancels and supersedes **MO-312, Wood Preservation**, of January 1968. It has been reviewed in accordance with the Secretary of the Navy Instruction 5600.16A and is certified as an official publication of the Naval Facilities Engineering Command.



D. B. CAMPBELL

Assistant Commander for

Public Works Centers and Departments

ABSTRACT

This publication provides information about treated wood products used throughout the Navy shore establishment. This manual specifically covers wood as a construction material, wood identification, wood deterioration, preservation of new wood products, quality control or how to specify and inspect treated wood products, as well as maintenance of treated wood products and remedial control.

CHANGE CONTROL SHEET

Document all changes, page replacements, and pen and ink alterations posted in this manual.

AMENDMENT NUMBER	AMENDMENT DATE	POST DATE	POSTED BY (LAST NAME)

Table of Contents

1. INTRODUCTION	1-1
------------------------	------------

1.1 PURPOSE.	1-1
1.2 SCOPE.	1-1
1.3 INTENDED AUDIENCE.	1-1

2. WOOD AS A CONSTRUCTION MATERIAL	2-1
---	------------

2.1 VISIBLE CHARACTERISTICS.	2-1
2.1.1 Softwoods And Hardwoods.	2-1
2.1.1.1 Commercial Species Groups.	2-1
2.1.1.2 Other Groupings.	2-3
2.1.2 Growth Increments.	2-3
2.1.2.1 Texture.	2-3
2.1.2.2 Earlywood and Latewood.	2-3
2.1.2.3 “Pores”.	2-5
2.1.3 Grain (Planes Or Surfaces).	2-5
2.1.3.1 End.	2-5
2.1.3.2 Radial.	2-5
2.1.3.3 Tangential.	2-8
2.1.3.4 Interlocked.	2-8
2.1.4 Sapwood And Heartwood.	2-8
2.2 MICROSCOPIC STRUCTURE.	2-8
2.2.1 Cell Types.	2-10
2.2.1.1 Softwoods.	2-10
2.2.1.2 Hardwoods.	2-10
2.2.1.3 Pits.	2-14
2.3 CHEMICAL COMPOSITION.	2-14
2.3.1 Cellulose.	2-14
2.3.2 Hemicellulose.	2-14

2.3.3	Lignin.	2-14
2.3.4	Ash.	2-14
2.3.5	Extractives.	2-14
2.3.6	Natural Durability.	2-14
2.4	PHYSICAL PROPERTIES.	2-16
2.4.1	Density And Specific Gravity.	2-16
2.4.2	Permeability.	2-16
2.4.3	Moisture Content.	2-16
2.4.3.1	Green Wood.	2-20
2.4.3.2	Fiber Saturation Point.	2-20
2.4.3.3	Bound Water.	2-20
2.4.3.4	Equilibrium Moisture Content.	2-20
2.4.3.5	Shrinking and Swelling.	2-20
2.4.4	Wood Drying Process.	2-23
2.4.5	Weathering.	2-23
2.5	MECHANICAL PROPERTIES.	2-23
2.5.1	Modulus Of Elasticity.	2-24
2.5.2	Modulus Of Rupture.	2-24
2.5.3	Compression Strength.	2-24
2.5.4	Tensile Strength.	2-24
2.5.5	Shear.	2-24
2.5.6	Side Hardness.	2-24
2.5.7	Toughness.	2-24
2.6	STRENGTH AFFECTING CHARACTERISTICS.	2-28
2.6.1	Abnormal Wood.	2-28
2.6.1.1	Juvenile Wood.	2-28
2.6.1.2	Reaction Wood.	2-28
2.6.1.3	Spiral Grain.	2-31
2.6.1.4	Knots.	2-31
2.6.2	Anatomical Disruptions.	2-31

2.6.2.1 Shake.	2-31
2.6.2.2 Split.	2-31
2.6.2.3 Compression Failure.	2-31
2.6.2.4 Cross Break.	2-32

3. WOOD IDENTIFICATION **3-1**

3.1 SPECIES SEPARATION.	3-1
3.2 SPECIES DESCRIPTIONS DETAILED.	3-5
3.2.1 Softwoods.	3-5
3.2.1.1 Douglas-fir.	3-5
3.2.1.2 Western Hemlock.	3-6
3.2.1.3 White Fir.	3-6
3.2.1.4 Southern Yellow Pine.	3-7
3.2.1.5 Miscellaneous Yellow Pines.	3-7
3.2.2 Hardwoods.	3-7
3.2.2.1 Red Oak.	3-7
3.2.2.2 White Oak.	3-8
3.2.2.3 Sweetgum.	3-8
3.2.2.4 Black Gum or Black Tupelo.	3-9
3.2.2.5 Water Tupelo, Tupelo Gum or Swamp Tupelo.	3-9
3.2.2.6 Mixed Hardwood Species.	3-9

4. WOOD DETERIORATION **4-1**

4.1 BACTERIA.	4-1
4.2 FUNGI.	4-1
4.2.1 Mold.	4-7
4.2.2 Sapstains.	4-7
4.2.2.1 Biological.	4-7
4.2.2.2 Chemical.	4-7
4.2.3 Wood Decay.	4-10

4.2.3.1 In Manufactured Products.	4-10
4.2.3.2 In Trees.	4-15
4.3 INSECTS.	4-19
4.3.1 Subterranean Termites.	4-19
4.3.1.1 Native Species.	4-19
4.3.1.2 Formosan.	4-23
4.3.2 Drywood Termites.	4-28
4.3.3 Dampwood Termites.	4-30
4.3.4 Carpenter Ants.	4-30
4.3.5 Powder Post and Other Wood Boring Beetles.	4-33
4.3.5.1 Classifications.	4-34
4.3.5.2 Prevention and Control.	4-44
4.3.6 Carpenter Bees.	4-48
4.4 MARINE BORERS.	4-50
4.4.1 Mollusca.	4-53
4.4.1.1 Teredo.	4-53
4.4.1.2 Bankia.	4-53
4.4.1.3 Martesia.	4-55
4.4.2 Crustacea.	4-55
4.4.2.1 Limnoria.	4-55
4.4.2.2 Sphaeroma.	4-56

5. PRESERVATION OF NEW WOOD PRODUCTS TO PREVENT DECAY AND INSECT ATTACK 5-1

5.1 NEED FOR PRESERVATIVES.	5 - 1
5.2 SUPERFICIAL TREATMENTS.	5 - 1
5.2.1 Treatment Quality.	5 - 1
5.2.2 Non Pressure Methods Of Application.	5 - 1
5.2.2.1 Brush.	5 - 1
5.2.2.2 Spray.	5 - 1

5.2.2.3 Dip.	5-1
5.2.2.4 Vacuum.	5-2
5.3 IN-DEPTH TREATMENTS.	5-2
5.3.1 Treatment Quality.	5-2
5.3.1.1 Penetration.	5-2
5.3.1.2 Retention.	5-2
5.3.1.3 Standards.	5-2
5.3.2 Pre-treatment Processing.	5-2
5.3.2.1 Debarking.	5-2
5.3.2.2 Drying.	5-2
5.3.3 Treating Methods.	5-4
5.3.3.1 Pressure.	5-4
5.3.3.2 Hot and Cold Bath or Open Tank Treatment.	5-7
5.3.3.3 Diffusion.	5-7
5.3.4 Preservative Chemicals.	5-7
5.3.4.1 Organic Preservatives.	5-7
5.3.4.2 Water Borne Preservatives.	5-8
5.3.5 Standards.	5-9
5.4 CARE AND HANDLING OF TREATED WOOD.	5-9
5.4.1 Exposure Of Untreated Wood.	5-9
5.4.2 Handling And Storage.	5-9
5.5 SAFETY AND ENVIRONMENTAL CONCERNS.	5-18
5.5.1 Acceptable Preservatives.	5-18
5.5.2 Consumer Information Sheets.	5-18
5.5.2.1 Inorganic Arsenical Pressure-Treated Wood (including: CCA, ACA and ACZA).	5-18
5.5.2.2 Pentachlorophenol Pressure-Treated Wood.	5-20
5.5.2.3 Creosote Pressure-Treated Wood.	5-22
5.5.3 Disposal Of Chemicals And Containers.	5-23
5.5.4 Preservative Poisoning.	5-24
5.5.5 First Aid.	5-24

6. QUALITY MANAGEMENT

6-1

6.1 PROCUREMENT SPECIFICATIONS. 6-1

6.1.1 Material Specifications. 6-1

6.1.1.1 Natural Variability. 6-1

6.1.1.2 Defects. 6-2

6.1.1.3 Specific Products. 6-2

6.1.1.4 Unique DOD Needs. 6-2

6.1.2 Treatment Specifications. 6-3

6.1.2.1 Major Components. 6-3

6.1.2.2 Examples of Treatment Specifications. 6-5

6.1.2.3 Unique DOD Needs. 6-5

6.1.2.4 Inspection Requirements. 6-5

6.2 INSPECTIONS. 6-6

6.2.1 Type of Inspections. 6-6

6.2.2 Approved Inspection Agencies. 6-6

6.2.3 U.S. Navy Policy. 6-7

6.2.4 Spot Checking Incoming Shipments. 6-7

6.2.4.1 Referral. 6-7

6.2.4.2 Evidence of Independent Inspection. 6-7

6.2.4.3 Certificates. 6-12

6.2.5 Inspection Methods. 6-12

7. PREVENTIVE MAINTENANCE AND REMEDIAL CONTROL

7-1

7.1 POLES. 7-1

7.1.1 Problems To Be Found. 7-1

7.1.1.1 Decay. 7-1

7.1.1.2 Insects. 7-4

7.1.2 Inspection Procedures. 7-4

7.1.2.1 Visual. 7-4

7.1.2.2 Physical Tests. 7-6

7.1.2.3 Biological Tests.	7-10
7.1.3 Determination Of Serviceability.	7-12
7.1.4 Remedial Treatment.	7-12
7.1.4.1 Ground Line or Bandage Treatment.	7-12
7.1.4.2 Internal Void Treatment.	7-13
7.1.4.3 Reinforcement or Stubbing.	7-15
7.2 PILES.	7-15
7.2.1 Problems To Be Found.	7-15
7.2.1.1 Decay.	7-15
7.2.1.2 Marine Borers.	7-15
7.2.2 Inspection Procedures.	7-15
7.2.2.1 Marine Borers.	7-18
7.2.2.2 Shipworms.	7-18
7.2.2.3 Sacrificial Test Blocks.	7-18
7.2.2.4 Sonic Testing.	7-18
7.2.3 Remedial Treatments.	7-20
7.2.3.1 Determining Serviceability.	7-20
7.2.3.2 Decay Prevention.	7-20
7.2.3.3 Borer Damage.	7-21
7.2.3.4 Barriers.	7-21
7.3 TIMBERS AND OTHER HEAVY WOOD MEMBERS.	7-21
7.3.1 Problems To Be Found.	7-21
7.3.1.1 Nature of Timbers.	7-21
7.3.1.2 Construction Techniques.	7-22
7.3.2 Inspection Procedures.	7-22
7.3.2.1 Visual.	7-22
7.3.2.2 Detecting Decay.	7-22
7.3.3 Remedial Treatments.	7-22
7.4 CROSSTIES.	7-24
7.4.1 Problems To Be Found.	7-24

7.4.2 Inspection Procedures.	7-24
7.4.3 Remedial Treatment.	7-24
APPENDIX A American Wood-Preservers' Association Standard	A-1
APPENDIX B Interim Federal Specification -- Wood Preservation: Treating Practices	B-1
BIBLIOGRAPHY	Bibliography-1
INDEX	Index-1

FIGURES

Figure No.	Title	Page
2-1	Section of Mature Southern Pine Tree Showing Gross Wood Structure	2-2
2-2	Earlywood (Light Colored) and Latewood (Dark Colored) in Both Edge and Flat Grain Samples of Southern Pine	2-4
2-3	Cross-Sections Showing (a) A Ring Porous Wood Elm, (b) A Diffuse Porous Wood, Birch and (c) A Semi Ring Porous Wood, Black Walnut	2-6
2-4	Radial Surface Showing Wood Rays	2-7
2-5	Interlocked Grain and Characteristic Checking Pattern in a Gum Railroad Tie	2-9
2-6	Three Dimensional View of Pine Showing Earlywood and Latewood, Tracheids and One Resin Canal	2-11
2-7	Large Resin Canals (Top Arrows) on the Side and End Grain of Sugar Pine and One Growth Increment (Bottom Arrow)	2-12
2-8	Three Dimensional View of Oak Showing Vessels or Pores, Fibers, Parenchyma and Ray Cells	2-13
2-9	Heartwood Permeability of Douglas-Fir by Geographic Location	2-19
2-10	Various Types of Warp	2-22
2-11	Modulus of Elasticity at 12% Moisture Content and Allowable Design Values for Select Species at 19% Moisture Content	2-25
2-12	Modulus of Rupture at 12% Moisture Content and Allowable Design Values for Select Species at 19% Moisture Content	2-26
2-13	Shear Strength at 12% Moisture Content and Allowable Design Values for Select Species at 19% Moisture Content	2-27
2-14	Juvenile Wood with Cross Grain Checking and Compression Wood in Ponderosa Pine	2-29
2-15	"Shelling" from Compression Wood in a Southern Pine Utility Pole	2-30

FIGURES

Figure No.	Title	Page
3-1	Douglas-Fir, Southern Yellow Pine, Western Hemlock, and White Fir (from left to right) are Four Major Softwood Species (note the narrow Band of Heartwood in the Center of the Southern Yellow Pine Sample)	3-3
3-2	White Oak, Red Oak, Sweetgum and Black Gum (from left to right) are Four Major Hardwood Species (Note the Course Texture of the Oaks, Especially Red Oak and the Variegated Pattern in Sweetgum)	3-4
4-1	Bacterial Damage in Sapwood Cut from Untreated White Pine (left) and Red Pine (right) Piling Submerged for 85 Years in Freshwater	4-6
4-2	Surface Mold on Sweetgum Veneer	4-8
4-3	Sapstain in a Cross Section of Pine	4-9
4-4	Interior Oxidation or Chemical Stain of Yellow Poplar	4-11
4-5	When Wet Wood is Probed with a Pick or Comparable Tool, it Tends to Lift Out as a Long Sliver or it Breaks by Splintering if Sound (left) but if Decayed even Slightly it Tends to Lift in Short Lengths and to Break Abruptly, Without Splintering (right)	4-12
4-6	Early Stage of Brown Rot Showing Discoloration on Side Grain (top right) and End Grain (top left) of the Same Board and Across Grain Cracking and Collapsed Wood Associated with Advanced Brown Rot (bottom)	4-13
4-7	Discoloration from White Rot on End Grain, Characterized by Mottling and Dark Zone Lines (arrows) Bordering the Abnormally Light-Colored Areas (top) and Side Grain of the Same Board (bottom)	4-14
4-8	Typical Surface Checking of Soft-Rotted Wood when Dry	4-16
4-9	White Pocket Rot in Douglas-Fir	4-17
4-10	Brown Pocket Rot in Western Red Cedar	4-18
4-11	Range Map for Subterranean (A) and Drywood (B) Termites	4-20
4-12	Termite Damaged Wood Showing the Insects' Preference for the Softer Earlywood and Accumulation of Soil and/or Fecal Material in the Galleries	4-21
4-13	Winged Subterranean Termite Swarms	4-22
4-14	Subterranean Termite Shelter Tubes on the Interior Foundation Wall of a Crawl Space Type House	4-24
4-15	Subterranean Termite Workers	4-25
4-16	Hazard Regions for Subterranean Termites	4-26

FIGURES

Figure No.	Title	Page
4-17	Head of Native Subterranean Soldier (A) and a Formosan Subterranean Soldier (B)	4-27
4-18	Drywood Termite Damage Showing Round “Kick Holes” and the Very Thin Veneer-Like Layer Left after Excavating without Regard for Earlywood or Latewood	4-29
4-19	Major Differences between Ants and Termites include Waist and Wing Size	4-31
4-20	Carpenter Ant Damage to Douglas-Fir Showing Preference for Earlywood and Removal of Some Latewood to Allow Access Between Galleries	4-32
4-21	Anobiid Damage Showing Insect Exit Holes	4-35
4-22	Ash Shovel Handle Damaged by Lyctid Beetles	4-37
4-23	Bostrichid Damage in Hardwood	4-38
4-24	Cerambycid (Long-Horned Beetle or Round-Headed Wood Borer) Damage to Ash Showing the Tightly Packed, Rather Coarse Frass in the Galleries (top) and the Circular Exit Hole (bottom)	4-39
4-25	Buprestid or Flat-Headed Borer Damage to a Softwood Showing Rectangular Shaped Tunnels Cut at an Oblique Angle Indicating that the Damage was Done Prior to the Time the Log was Sawed	4-42
4-26	Damage to a Hardwood by Curculionids also known as Snout Beetles or Wood Boring Weevils	4-43
4-27	Scolytid or Bark Beetle Damage to Ash	4-45
4-28	Ambrosia Beetle or Columbian Timber Borer Damage to Soft Maple	4-46
4-29	Carpenter Bee Damage in Redwood Showing a Single Entry Hole (from inside) at the Top Center and Individual Cells (right)	4-49
4-30	Extensive Damage to a Wooden Waterfront Structure from Marine Borers (<i>Limnoria</i>)	4-51
4-31	Distribution of Marine Borers in the United States	4-52
4-32	Shipworm Damage	4-54
4-33	<i>Sphaeroma</i> and Associated Damage	4-57
5-1	Deep Checks or Cracks in Treated Sapwood have Allowed a Fungus to Penetrate and Decay the Untreated Interior of this Pole	5-3
5-2	Incising Improves the Treatability of Refractory Woods such as Douglas-Fir	5-5
5-3	Typical Treating Cylinder with Charge Ready for Processing	5-6

FIGURES

Figure No.	Title	Page
6-1	Examples of Hammer Marks used on Poles	6-4
6-2	“Quality Certified” Brand that Indicates Compliance with Standards of the National Wood Window and Door Association	6-10
6-3	Rendition of Quality Mark used by the American Wood Preservers Bureau and Stamps of AWPB-Certified Inspection Agencies	6-11
6-4	Quality Marks Used by the Southern Pine Inspection Bureau	6-14
6-5	Replica of Monel Tags used on Marine Piling by AWPB-Certified Inspection Agencies	6-15
6-6	SPIB Code used on Marine Piling and Camels	6-16
7-1	In this Well-Treated Southern Pine Pole, only a Small Area in the Center was left Untreated and Subject to Decay	7-2
7-2	External or Surface Decay is Most Common at the Ground Line	7-3
7-3	Serious Internal Decay has Occurred in this Pole Because Fungi Gained Access from the Woodpecker Damage and a Small Bore Hole (left)	7-5
7-4	Boring and Coring Tools: A, Auger-Type Bit used for Extracting Bored Shaving Samples; B, Plug Cutter and Plug Extractor; C, Increment Borer Consisting of Three Parts--Extractor, Hollow Bit, and Case that also Serves as a Handle for Turning Coring Bit into and out of Wood Members	7-7
7-5	Moisture Meter Suitable for Inspection Work	7-9
7-6	A Shell Thickness Indicator is used to Determine the Thickness of the Remaining Shell	7-11
7-7	A Metal Stub was used to Reinforce this Pole Before it was Removed from Service	7-16
7-8	Because the End of this Pole was Cut Off after Driving, Untreated Wood was Exposed and Decay Resulted	7-17
7-9	Untreated and Lightly Treated 2x4's Fastened to an Existing Marine Piling Provide a Simple Means for Determining which Marine Organisms are Present	7-19
7-10	Schematic Drawing of Typical Wood Bridge Construction Showing Likely Locations where Decay Could Develop	7-23

TABLES

Table No.	Title	Page
2-1	Comparative Decay Resistance of the Heartwood of Some Common Species	2-15

TABLES

Table No.	Title	Page
2-2	Specific Gravity and Shrinkage Values from Green to Six and Twenty Percent Moisture Content for Selected Domestic Species	2-17
2-3	Classification of Species with Respect to Heartwood Permeability	2-18
2-4	Recommended Moisture Content Values for Wood at Time of Installation	2-21
3-1	Gross Characteristics for Selected Softwood and Hardwood Species	3-2
4-1	Comparison of Characteristics of Brown Soft and White Rots, Molds, Sapstains and Bacterial Infected Wood	4-2
4-2	Comparison of Characteristics for Termites and Carpenter Ants	4-3
4-3	Summary Table of Exit/Entry Hole Size, Type and Condition of Wood Attacked, Appearance of Frass and Potential for Reinfestation for Wood Boring Beetles and Carpenter Bees	4-4
4-4	Comparison of Characteristics for Marine Borers	4-5
4-5	Schedule for Heat Treating Wood to Control Damage by Powderpost Beetles	4-47
5-1	Wood Products and Usage, Preservative Types and Retentions, and Applicable Standards	5-10
6-1	Brands Used on Forest Products Treated in Accordance with Standards of the American Wood Preservers' Association	6-8

CHAPTER 1. INTRODUCTION

Wood is an engineering material with known design properties and is used extensively for construction purposes. Each species or species group has certain unique characteristics that make it particularly suited for specific applications. These characteristics include strength properties, the ability of the wood to accept preservatives under pressure, natural decay and insect resistance, machinability, appearance and many others. Good performance will result when the proper materials are selected and correctly installed. The knowledge exists to do a wood construction job correctly--it simply must be applied.

In today's complex society of specialists, however, ample opportunity exists for errors. Specialists produce the wood products, a specialist often designs a project, engineering specialists certify the project, another specialist specifies or purchases the materials, another delivers it, and yet another installs the materials and inspects the final job. Still others are responsible for maintenance. To further complicate the situation, very few individuals in this chain, including engineers, have had any training regarding wood products. If errors are made by anyone in the chain and existing knowledge and expertise are not applied, time and precious natural resources could be wasted and lives can be endangered.

1.1 PURPOSE. This manual identifies key technical points that should be considered by personnel when preparing procurement orders, and accepting or installing treated wood products for U.S. Navy facilities. The care and handling of treated wood products received by the Navy will also be discussed.

1.2 SCOPE. The manual will cover (1) wood as a construction material, (2) wood identification, (3) wood deterioration, (4) preservation of new wood products to prevent decay and insect attack, (5) quality control, and (6) maintenance and remedial control.

1.3 INTENDED AUDIENCE. The manual is intended as a tool to assist supply procurement specialists, Public Works personnel, and EFD Applied Biologists.

1.3.1 Planner and Estimator. The Public Works Planner and Estimator will find Chapters 3, 4, 5, and 7 most helpful for planning jobs and ordering materials.

1.3.2 Public Works Inspectors. Public Works Inspectors will find Chapters 4 and 7 useful in identifying deficiencies and suggesting remedial actions.

1.3.3 Public Works Engineers. Public Works Engineers will find Chapters 4, 5, and 7 useful for specifying treated wood products.

1.3.4 Supply Personnel. Supply personnel should read Chapters 5 and 6.

1.3.5 EFD Applied Biologists. EFD Applied Biologists and Program Managers will find the entire manual informative with Chapters 4 through 7 most useful for overall program support.

CHAPTER 2. WOOD AS A CONSTRUCTION MATERIAL

Lumber, heavy timbers, poles, piles and many other wood products are derived from trees. Trees are biological organisms which we see and enjoy every day, but we seldom consider the complexity of the wood produced by them. An understanding of some of the basic characteristics and properties of wood can help in making sound decisions in selecting, specifying and, finally, using the many different wood products. In addition, a better understanding can also help solve problems when they arise in current applications.

This chapter will present an overview of the following particulars of wood:

- (1) Visible Characteristics
- (2) Microscopic Structure
- (3) Chemical Composition
- (4) Physical Properties
- (5) Mechanical Properties
- (6) Strength Affecting Characteristics

Also, these sections will emphasize design criteria and preservative treatment of wood products when applicable.

2.1 VISIBLE CHARACTERISTICS. Many characteristics can be readily observed with the naked eye or with the use of a 10x hand lens (Figure 2-1). These gross features are often good indicators of a species structural properties, and are helpful in identifying some of the more common species or species groups.

2.1.1 Softwoods And Hardwoods. The terms “hardwood” and “softwood” do not directly describe the hardness or softness of wood. Instead, they refer to the leaf form or mode of seed production on trees from which the wood is cut. The terms are especially confusing because some true hardwoods have softer or lighter wood than common softwoods. Softwoods also are very strong for their weight in comparison to the hardwoods. Softwoods are trees such as the pines, spruces, larch, true firs, hemlock, redwood, yew, cypress, Douglas-fir and cedars which have needle or scale-like leaves and, except for cypress and larch, maintain these leaves throughout the year. They are also called evergreens. Because they bear scaly cones to produce seeds, they are also called conifers. Softwoods are most commonly used for construction lumber, heavy timbers, poles and piles where strength, not appearance, is important.

Hardwoods are trees such as the oaks, gums and many others which have broad deciduous leaves. That is, their leaves change color in the fall and drop to the ground--at least in temperate climates. Hardwoods often are used for railroad ties, heavy timbers and pallets.

2.1.1.1 Commercial Species Groups. Softwoods are specified by “species groups”. These species groups are based on strength characteristics of the lumber. For example, if southern pine is specified, the shipment may contain any of the major species, namely loblolly,

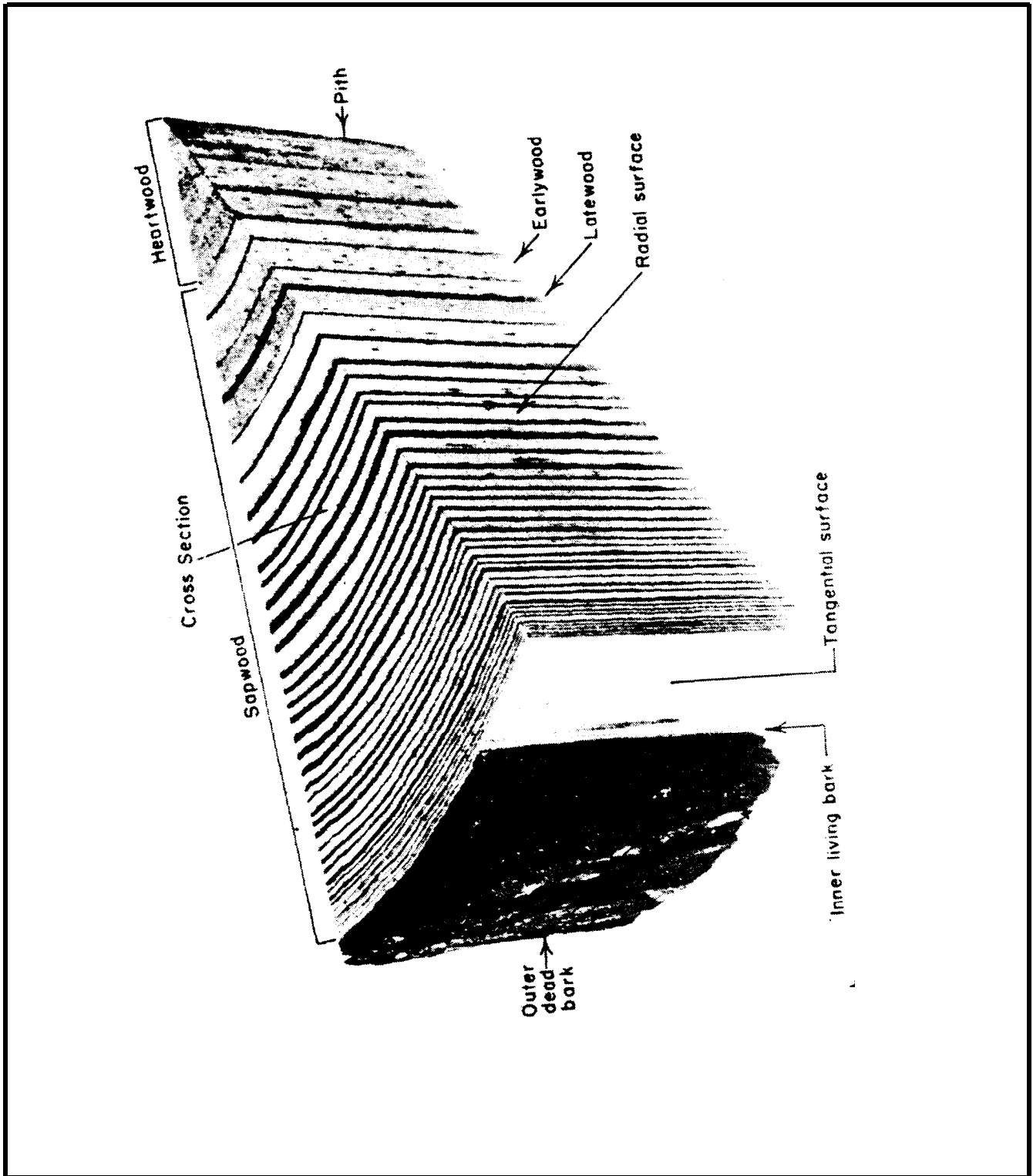

FIGURE 2-1
Section of Mature Southern Pine Tree Showing
Gross Wood Structure

longleaf, shortleaf or slash pine. Because of lower strength characteristics, two other southern pine species, Virginia and pond pine, are placed in a separate group called Virginia pine-pond pine. As another example, for western species, larch can be mixed in with Douglas-fir.

2.1.1.2 Other Groupings. Some species groups, based on strength properties, also have been established for hardwoods. For example, the National Wood Pallet and Container Association has set up three species groups for the manufacture of wood pallets and containers. These groups are based on species' density.

In other cases, only those species acceptable for a particular end use or with particular properties are grouped together. The American Railway Engineering Association publishes a list of those species acceptable as ties, and the American Wood Preservers' Association groups certain species according to processing requirements for pressure treating.

2.1.2 Growth Increments. A growth increment is that layer of wood which, each year, is added to the circumference of a tree. It is also referred to as an annual ring. The term "growth increment" is more correct since a few species, such as cypress and redwood, may form more than one ring or "false" ring per year. The width of a growth increment may vary from a few cells in width to as much as an inch in some fast growth woods. The rate of growth can affect the strength of the material.

2.1.2.1 Texture. Texture is a general term which can have several meanings. It can refer to the rate of growth, to the density, or to the degree of contrast between growth increments or parts of the growth increment. For example, slow growth hardwoods are referred to as fine textured, meaning that the growth increments are relatively narrow (close together) and, in the case of oak, the density is lower.

Texture can also be used to refer to the size, arrangement and appearance of the individual cells. Oak, with its large pores, is considered coarse textured, while maple has small pores and is considered fine textured.

2.1.2.2 Earlywood and Latewood. The growth increments in some softwood species, such as southern pine and Douglas-fir, are composed of two distinct parts. Earlywood (sometimes called springwood) is that portion of the growth increment which is formed during the first part of the growing season or usually in the spring. Earlywood cells are relatively large in diameter, thin-walled and lighter colored. Latewood (sometimes called summerwood) is formed after the earlywood (Figure 2-2). The latewood cells are smaller, thick-walled and darker. As a result, latewood is heavier and stronger than earlywood.

The growth rate or width of the growth increment, and the percent of latewood which it contains, are important factors in the grading of southern pine lumber where strength is desirable. For example, a grade called Dense Southern Pine is defined as averaging, one end or the other, not less than six annual rings per inch, and one-third or more of each annual ring is summerwood. Pieces

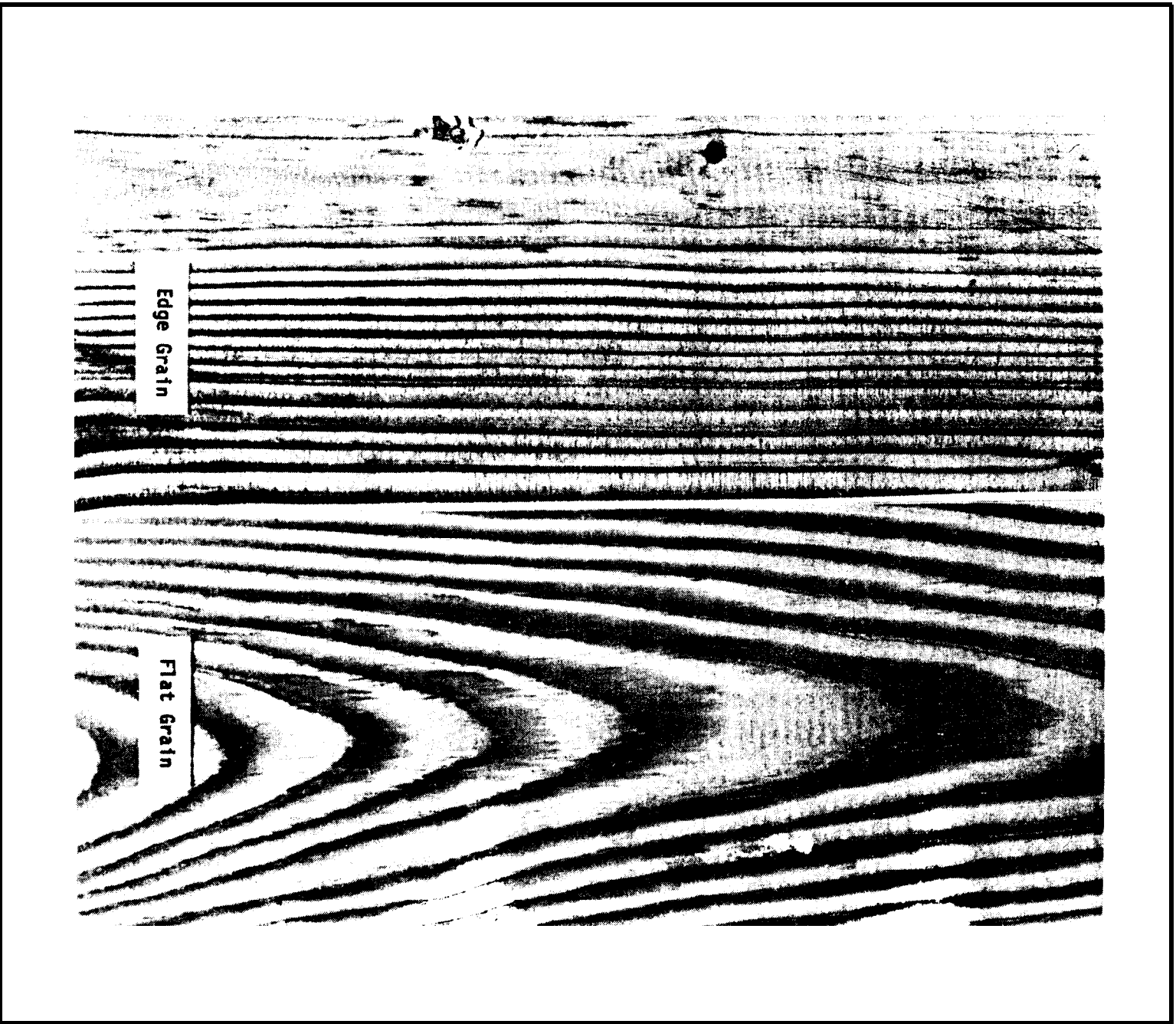

FIGURE 2-2

Earlywood (Light Colored) and Latewood (Dark Colored)
in Both Edge and Flat Grain Samples of Southern Pine

averaging not less than four annual rings per inch one-half summerwood are also classified as dense. Fast growth southern pine may have only two or three growth increments per inch and a relatively small percentage of latewood. Due to its lower strength properties, this material is placed in a lower grade. The specifications for railroad crossties also recognize the importance of growth rate in the softwoods. These specifications indicate that the purchaser may specify that any inch of any radius from the pith shall have six or more rings of annual growth throughout the top fourth of the tie.

The latewood in softwoods is more easily treated with wood preservatives than earlywood.

2.1.2.3 “Pores”. The distribution of large diameter cells (pores) within growth increments of hardwoods allows grouping of these hardwoods into three categories based on their cross sectional appearance (Figure 2-3). These categories are: ring porous, semi-ring porous, and diffuse porous. Ring porous woods have large diameter pores at the beginning of each growth increment. The pores can be easily seen with the naked eye. Ring porous woods include oak, ash and elm. Semi-ring porous woods, on the other hand, have pores that are initially large and then gradually decrease in diameter throughout the growth increment. Examples of semi-ring porous woods include walnut and butternut. In diffuse porous woods, the pores are uniform in size across the entire growth increment and are generally too small to be seen without the use of a hand lens. Diffuse porous woods include maples, yellow poplar, sweetgum, and others.

2.1.3 Grain (Planes Or Surfaces). Visible characteristics, shrinkage and mechanical properties of wood are defined in terms of the three planes in which wood can be cut (Figure 2-1). Characteristics of these surfaces can also be useful in the identification of wood. In reality, however, very few boards are perfectly cut on one of these planes. The saw cut usually ends up at some angle between them.

2.1.3.1 End. End grain (cross section) is the surface exposed when wood is cut across the width of a log or board. The end grain reveals the annual rings and, thus, is a key surface for identification of wood when using a hand lens to determine cell structure.

Because the end grain is porous it absorbs preservatives more easily than side grain (radial or tangential)

2.1.3.2 Radial. The radial surface is exposed when a log is cut longitudinally from its center to the bark (along the radius). In the hardwood industry, lumber cut this way is known as quartered lumber. Some large timbers and railroad ties will show ray flecks if on one face a large log is cut through the pith (Figure 2-4). Sycamore and beech are two more wood species which can be quartered to show distinctive ray flecks, but these are not as large as in oak. Some softwood species, such as southern pine and Douglas-fir, are quartered to expose a vertical grain pattern, and are used for flooring because of the high resistance to wear. This lumber is sometimes referred to as edge grain (Figure 2-2).

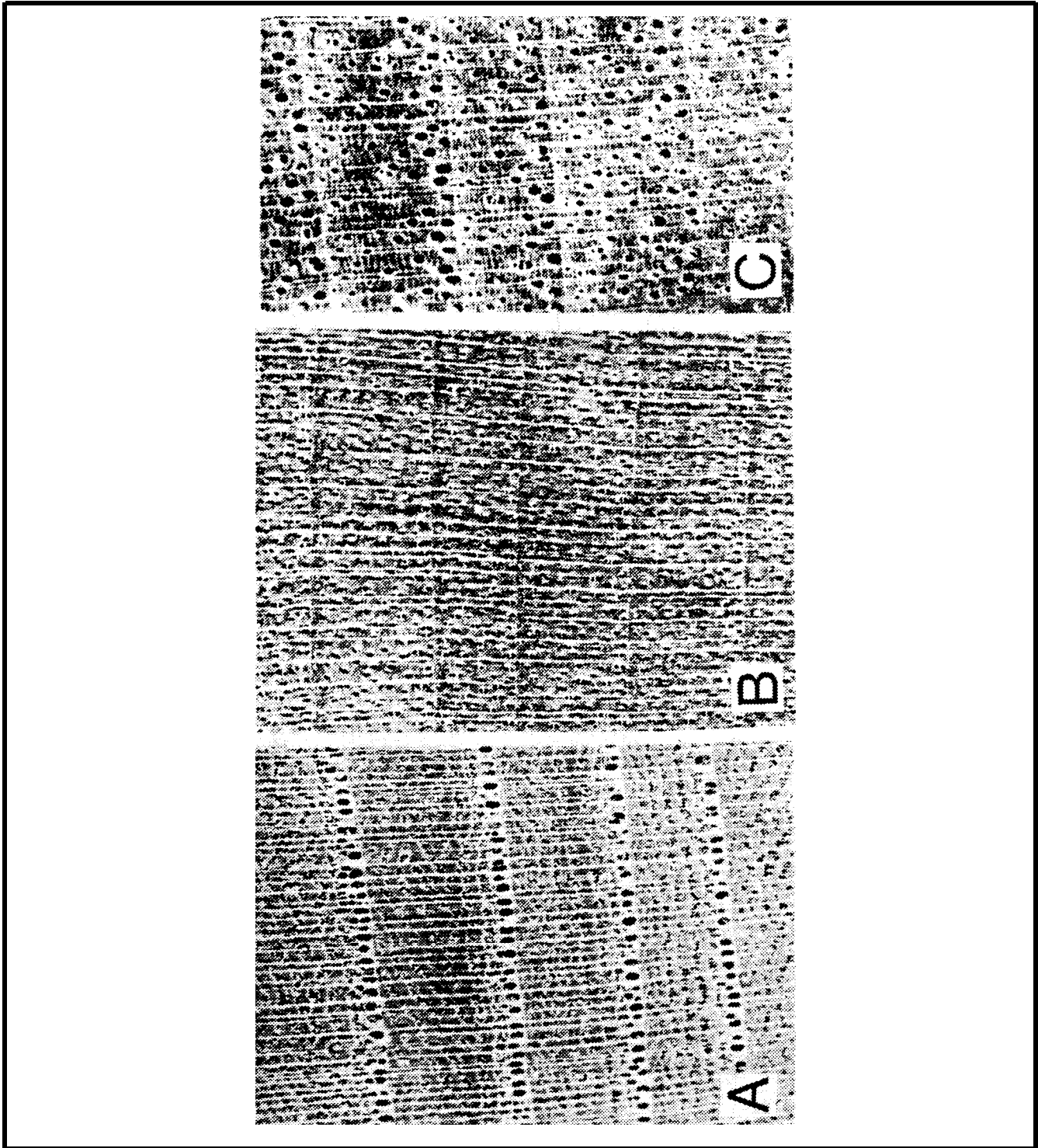

FIGURE 2-3
Cross-Sections Showing (a) A Ring Porous Wood, Elm,
(b) A Diffuse Porous Wood, Birch and
(c) A Semi Ring Porous Wood, Black Walnut

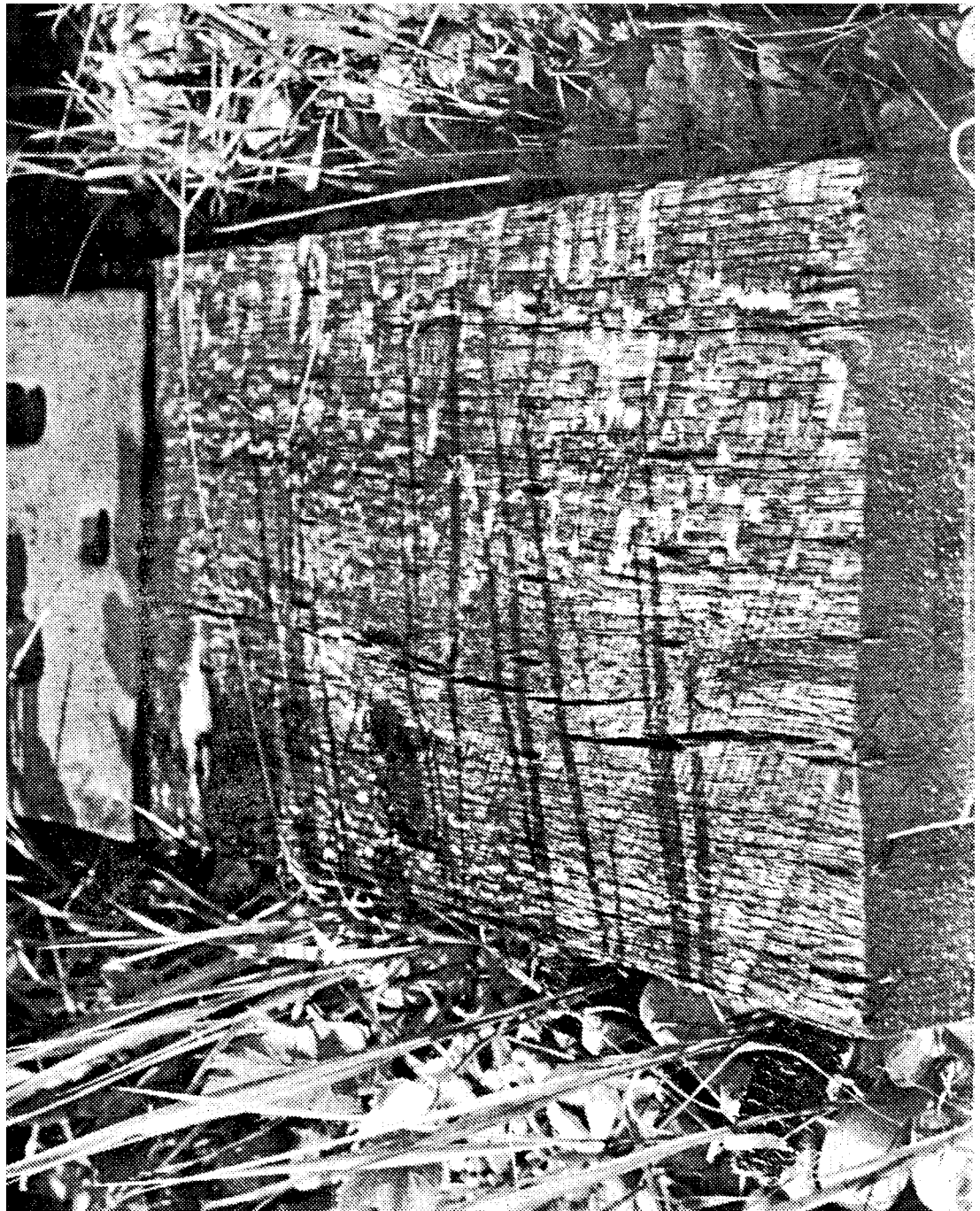

FIGURE 2-4
Radial Surface Showing Wood Rays

2.1.3.3 Tangential. The tangential surface is exposed when a board is cut parallel to the bark and tangent to the log diameter. The lumber is called flat or plain sawn. This is the most common way of producing lumber today, and it results in a characteristic U or V-shaped grain pattern (Figure 2-2) in the softwoods with distinct earlywood and latewood bands, such as southern pine and Douglas-fir, and the coarse grained hardwoods such as oak.

2.1.3.4 Interlocked. Interlocked grain occurs when the longitudinal wood cells spiral normally in one direction for one to several years, and then reverse direction. Interlocked grain is characteristic of gums. Woods with interlocked grain are difficult to split, may shrink somewhat more longitudinally than normal upon drying and often warp excessively. Figure 2-5 shows a characteristic checking pattern in a gum railroad tie due to interlocked grain.

2.1.4 Sapwood And Heartwood. The wood formed immediately inside the bark of a tree is called sapwood. Sapwood is light in color and contains living cells that transport water from the roots to the branches and leaves at the top of the tree. Heartwood is formed in the central part of the tree stem, as those water conducting cells die.

The relative thickness of sapwood and heartwood in stems of various tree species is an important characteristic. Heartwood of some tree species is difficult to treat with preservatives, but sapwood of all species accepts preservatives. Heartwood may compose most of the stem in mature Douglas-fir and oak. Southern yellow pine poles and lumber readily accept preservatives because these trees and lumber are mostly sapwood (Figure 2-1). By contrast, poles and lumber cut from mature Douglas-fir trees contain a high proportion of impermeable or refractory heartwood that is difficult to treat. The heartwood of red oak is permeable whereas that of white oak is some of the most impermeable wood. It is this type of species, and variable treatability, that shapes the grouping of wood products by species in standards for wood preservative treatments.

Very few, if any, differences exist in the mechanical properties of sapwood and heartwood. Heartwood of some species may have a slightly higher weight per unit volume than sapwood due to the presence of significant amounts of extractives. Due to an accumulation of various materials, extractives, pitch, oil, and other extraneous substances, the heartwood is often darker than sapwood.

2.2 MICROSCOPIC STRUCTURE. Wood is composed of many individual cells held together much like a hand full of soda straws. The cells that contribute most to wood strength are oriented in a longitudinal direction, essentially parallel to or with a very slight deviation from the long axis of the tree stem. Other cells that store food or produce extractives are of different shapes and structure. The presence or absence of certain types of cells, their size, and the manner in which these cells are arranged determines the properties of any one particular wood species, and are critical keys in the accurate identification of wood species. The microscopic structure of softwoods and hardwoods is summarized below.

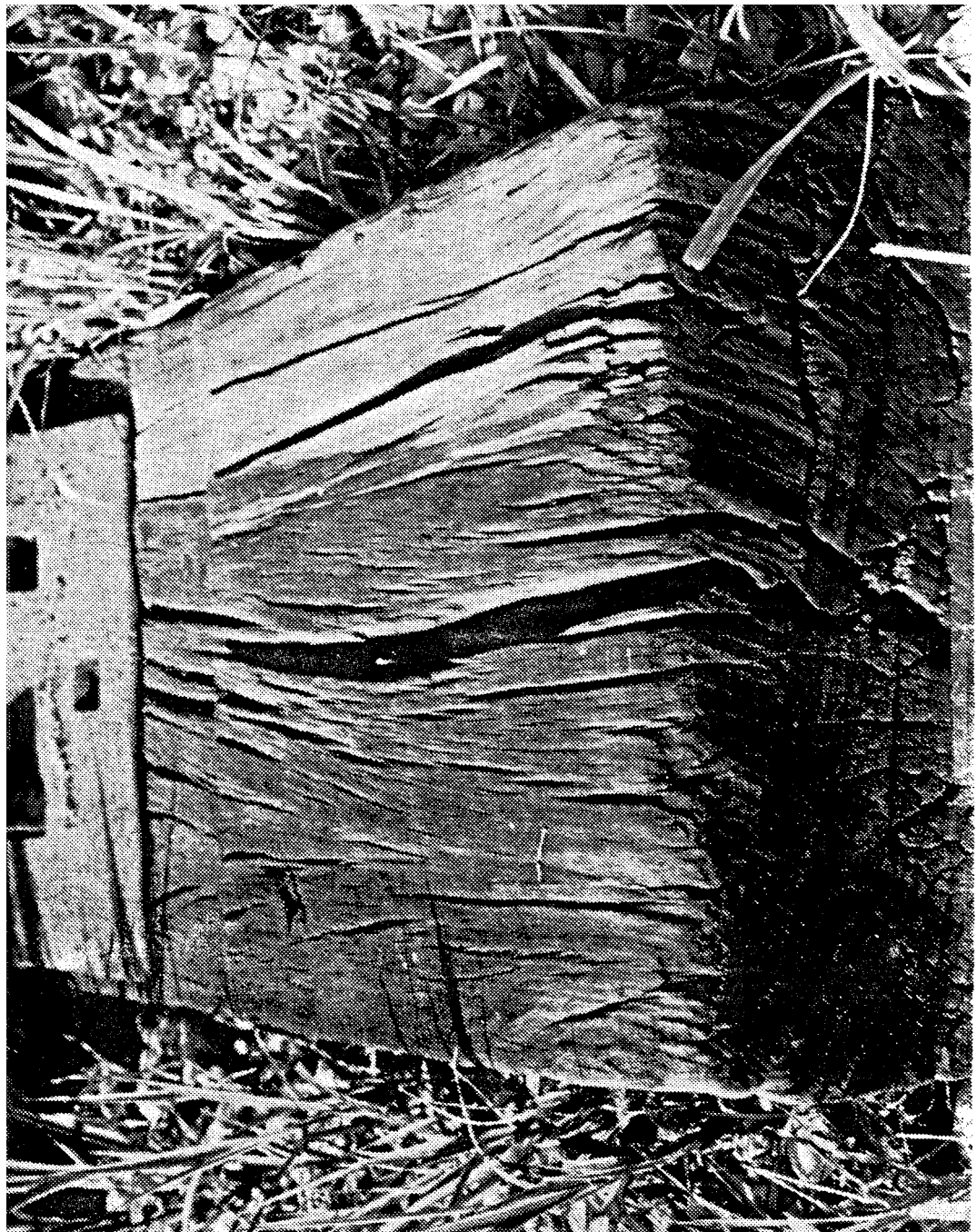

FIGURE 2-5
Interlocked Grain and Characteristic Checking Pattern
in a Gum Railroad Tie

2.2.1 Cell Types.

2.2.1.1 Softwoods.

Tracheids. Tracheids are the principal longitudinal cell type in softwoods. Tracheids, or fibers (Figure 2-6) as they are sometimes referred to, comprise 90 to 95 percent of the volume of the wood, and are about 100 times longer than they are in diameter. They contribute greatly to the strength of a wood. The diameter of tracheids varies from one species to the next. This difference is readily observed with a hand lens, and is useful for identification purposes.

Parenchyma. Parenchyma cells are generally short, thin-walled cells which are connected together in strands and serve primarily for storage and distribution of carbohydrates.

Resin canals are tubular passageways lined with living parenchyma cells which exude resin or pitch. In pine, resin canals are easily seen with the naked eye on the end grain as well as the side grain (Figure 2-7)

2.2.1.2 Hardwoods. The hardwoods have more cell types and the variation in the size and arrangement of these cells is greater than in the softwoods (Figure 2-8). As a result, the hardwoods are more varied in appearance, and may have unique characteristics making certain species more desirable for selected end uses than others.

Vessels (Pores). Vessels are relatively large diameter, thin-walled, round cells that are connected end to end to form microscopic tubes that are ideal for sap conduction. It is the vessels which constitute the pores in hardwoods (Figure 2-3). The presence of large diameter unobstructed vessels makes some woods easy to treat. Red oak is an example. Its structure is so open that smoke can be blown through short pieces of the wood.

Fibers. Fibers are relatively small diameter, elongated cells with thick walls and closed ends. Fibers are primarily responsible for the strength characteristics of hardwood.

Parenchyma. In the hardwoods, parenchyma cells vary widely in size and arrangement. In oak, beech, and sycamore, the rays (mostly parenchyma cells) are conspicuous to the naked eye and aid greatly in the identification of these species.

Miscellaneous. Hardwoods contain other miscellaneous features which are often important in identification, as well as the end use of the product. For example, white oak contains tyloses. Tyloses are literally plugs in the vessels or pores of this species group. Thus, white

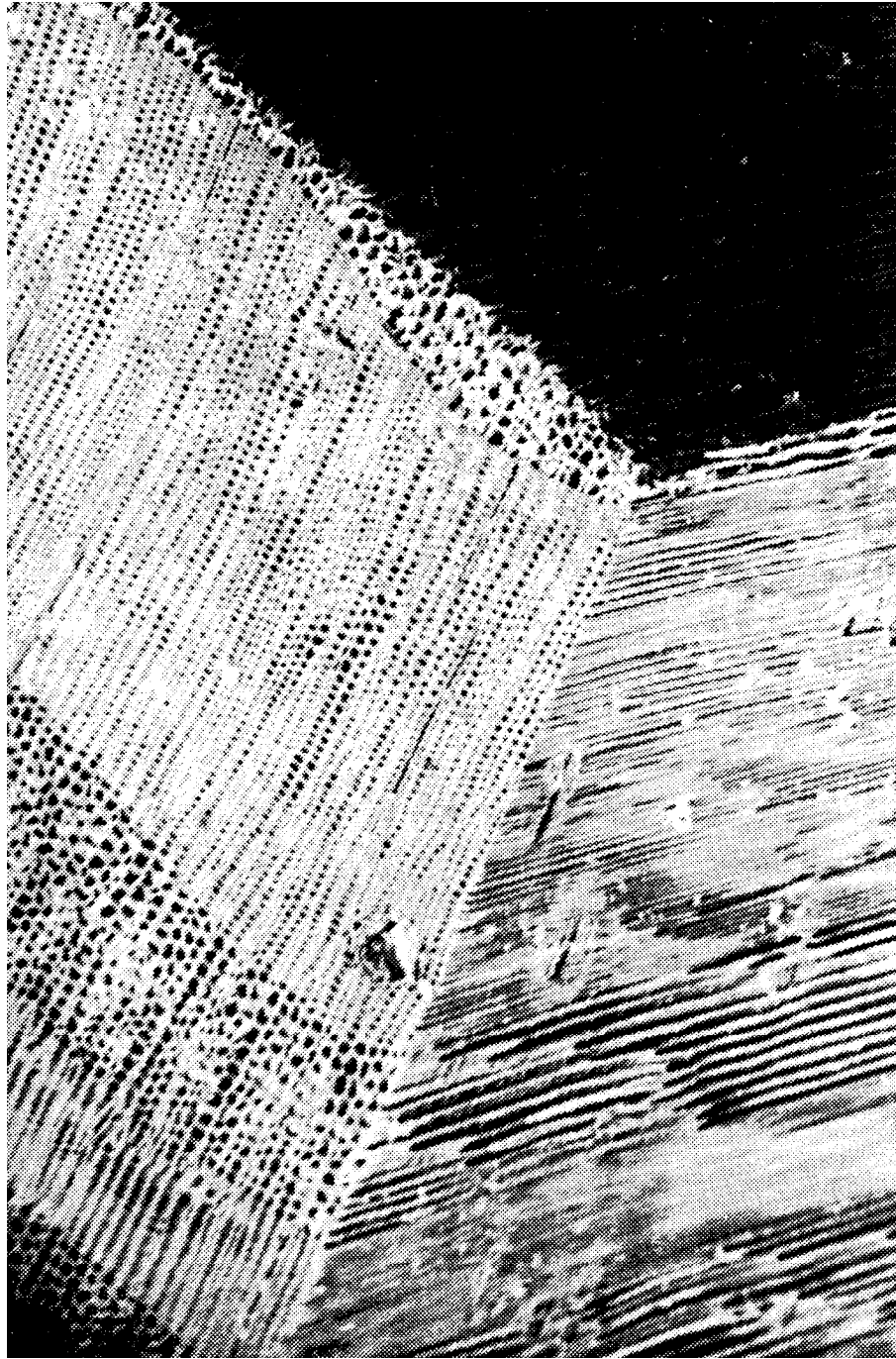

FIGURE 2-6
Three Dimensional View of Pine Showing Earlywood
and Latewood, Tracheids and One Resin Canal

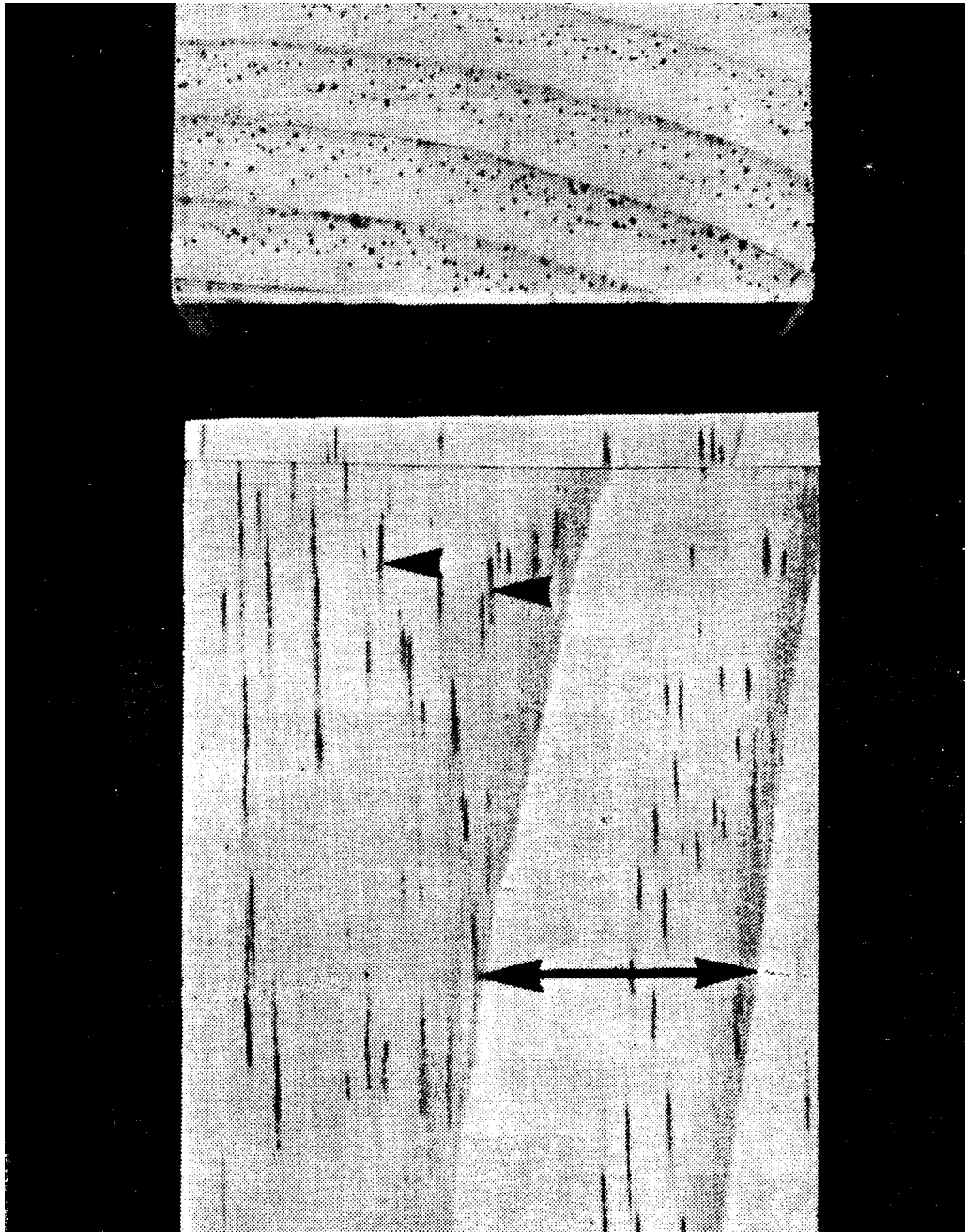

FIGURE 2-7
Large Resin Canals (Top Arrows) on the Side and End Grain
of Sugar Pine and One Growth Increment (Bottom Arrow)

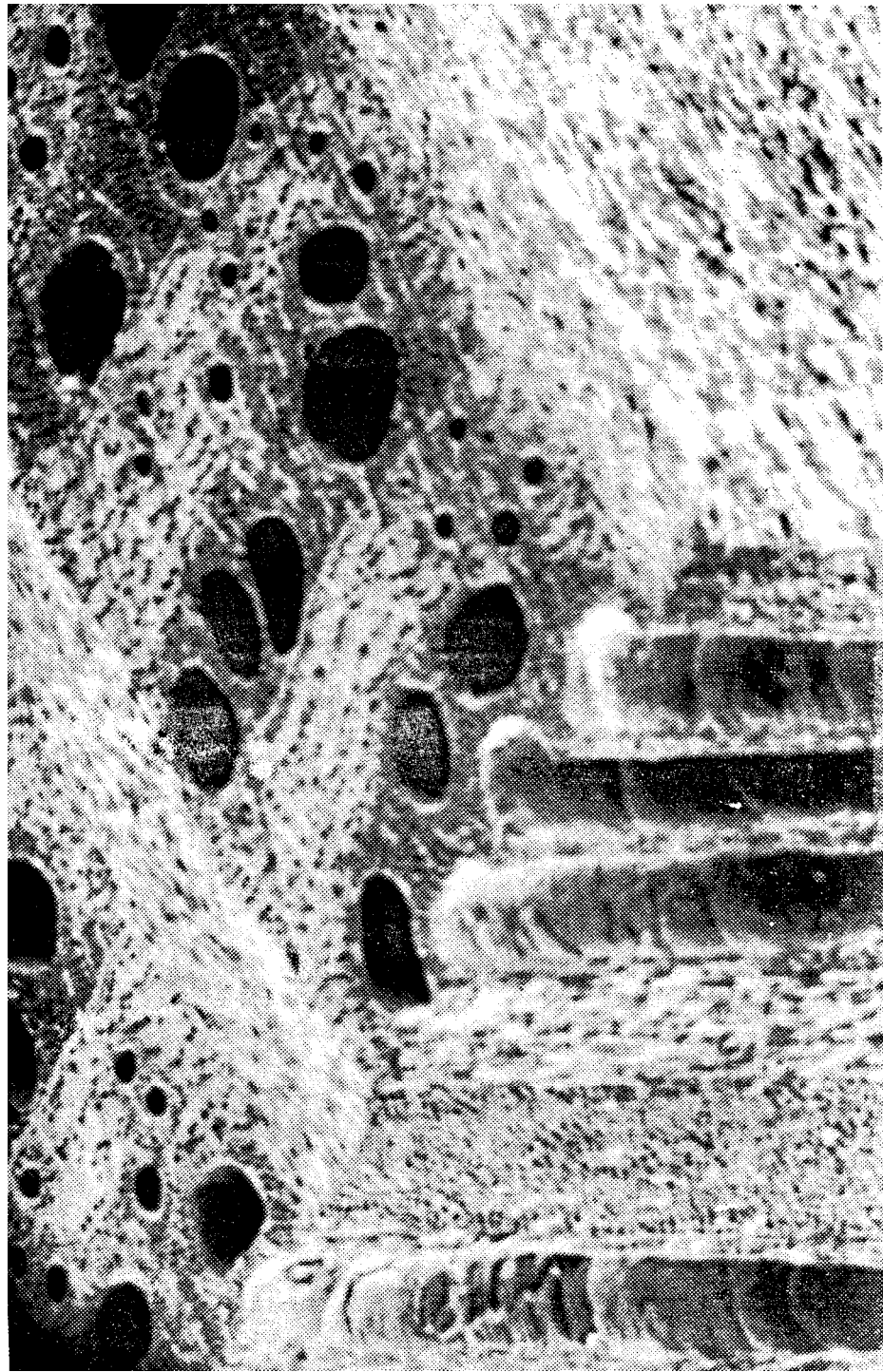

FIGURE 2-8
Three Dimensional View of Oak Showing Vessels
or Pores, Fibers, Parenchyma and Ray Cells

oak is used to make tight cooperage (whiskey barrels), and does not accept preservative treatment well.

2.2.1.3 Pits. Individual cells in both hardwoods and softwoods are connected together by means of pits that allow movement of liquids between cells. Pits are important in softwoods since preservatives move from one cell to the next through them.

2.3 CHEMICAL COMPOSITION. The discussion provided here is a very general and elementary review of the complex chemical structure of wood.

2.3.1 Cellulose. Cellulose comprises about 40 to 45 percent of the oven-dry weight of wood. Long strands of cellulose molecules arranged more or less parallel to each other within the thick walls of structural cells (fibers and tracheids) contribute a high tensile strength to wood.

2.3.2 Hemicellulose. Hemicelluloses constitute from 20 to 35 percent of the oven-dry weight of the wood. The exact function of the hemicelluloses is not clear. Some possibility exists that they serve as a temporary matrix before lignification.

2.3.3 Lignin. Lignin constitutes from 15 to 35 percent of the oven-dry weight of the wood. It reinforces the cellulose portion of the cell wall, thereby contributing to the rigidity of wood. Lignin is a complex polymer and its chemical structure is not fully understood.

2.3.4 Ash. The inorganic materials, or ash as they are often referred to, generally constitute less than one percent of the oven-dry weight of the wood. The most common constituents, in order, are calcium, potassium, magnesium, carbonates, phosphates, silicates and sulfates.

2.3.5 Extractives. In addition to the major structural components--cellulose, hemicellulose, and lignin--most woods usually contain some type of extractives. Most extractives are located in the heartwood and are water soluble. They are often responsible for the general darkening of the heartwood, for the resistance of some heartwood to decay and insect attack, for odor, and for good dimensional stability. The more important organic extractives include the terpenes, resin acids, polyphenols, tannins, and tropolenes.

2.3.6 Natural Durability. Some of the extractives, pitch, oil and other extraneous substances deposited in the heartwood impart resistance to decay and insects, thus making some species more durable than others (Table 2-1). Where the extractives do not have a toxic or repellent effect, the heartwood is no more resistant than the sapwood.

In the past, old growth naturally durable woods such as cedars, cypress, redwood, chestnut and some others were generally available and commonly used to prevent deterioration. Now, the demand for durable products exceeds potential supply, or they are too expensive for general construction purposes. As a result, wood properly treated with preservatives is more commonly utilized

TABLE 2-1

Comparative Decay Resistance of the Heartwood of Some Common Species

Resistant or Very Resistant	Moderately Resistant	Slight or No Resistance
Catalpa	Baldcypress ¹	Alder
Cedars	Douglas-fir	Ashes
Cherry, Black	Honeylocust ²	Aspens
Chestnut	Larch, western	Basswood
Cypress, Arizona	Oak, swamp chestnut	Beech
Jumpers	Pine, eastern white ¹	Birches
Locust, blacks ³	Pine, longleaf ¹	Buckeye ²
Mulberry, red ³	Pine, slash	Butternut
Oak, bur	Tamarack	Cottonwood
Oak, chestnut		Elms
Oak, Gambel		Hackberry
Oak, Oregon white		Hemlocks
Oak, post		Hickories
Oak, white		Magnolia
Osage-orange ³		Maples
Redwood		Oak (red and black species) ²
Sassafras		Pines (most other species) ²
Walnut, black		Poplar
Yew, Pacific ³		Spruces
		Sweetgum ²
		Sycamore
		Willows
		Yellow-poplar

¹The southern and eastern pines and baldcypress are now largely second growth with a large proportion of sapwood. Consequently, substantial quantities of heartwood lumber from these species are not available.

²These species have higher decay resistance than most of the other woods in their categories.

³These woods have exceptionally high decay resistance.

2.4 PHYSICAL PROPERTIES. The physical properties considered here include moisture content and explanation of the wood drying process, dimensional stability, density and specific gravity, permeability and weathering.

2.4.1 Density And Specific Gravity. Density is the single most important indication of strength in defect-free wood, and is an indicator of many characteristics, such as, ease of machining, hardness, and others. Density is the weight of wood per unit volume; that is, pounds per cubic foot. The moisture content should also be given because it will greatly affect the density. Generally, as the density of wood increases, so does its strength. Dense woods also tend to shrink and swell more than lightweight woods.

Specific gravity (Table 2-2) is another term commonly used when talking about the relative weights of different woods. Specific gravity is the ratio of the oven-dry weight (i.e., weight of the wood at zero percent moisture content) of a given volume of wood to that of an equal volume of water at a standard temperature.

2.4.2 Permeability. The permeability of wood is the extent to which it allows fluid flow through a porous medium under the influence of a pressure gradient. There is a good correlation between wood permeability and treatability.

The “treatability” describes the ease with which preservatives can be forced into wood under pressure. As with the many other wood characteristics, treatability varies with the different wood species (Table 2-3). Significant variability may also occur within a given species. Douglas-fir heartwood is a good example. Coastal Douglas-fir is permeable, Cascade Mountain sources are moderately impermeable and intermountain sources are impermeable or refractory (Figure 2-9).

Lastly, the permeability and, hence, the treatability of wood varies with grain direction. The penetration ratio of end grain to side grain for the preservative oils is almost 15 to 1 and 20 to 1 for the water-borne preservatives.

2.4.3 Moisture Content. Because the amount of water in wood (moisture content) affects wood treatability, durability and stability, wood moisture content is often referenced in specifications.

The moisture content of wood is the ratio of the weight of water in wood to the weight of wood when it is oven-dry. The following formula is used to calculate the moisture content of wood.

$$\text{Moisture Content(\%)} = \frac{\text{Initial wt.} - \text{Oven-dry wt.}}{\text{Oven-dry wt.}} \times 100$$

TABLE 2-2

Specific Gravity and Shrinkage Values from Green to Six and Twenty Percent Moisture Content for Selected Domestic Species

Species	Specific Gravity ¹	Shrinkage to 6 percent moisture content		Shrinkage to 20 percent moisture content	
		Radial	Tangential	Radial	Tangential
		(%)	(%)	(%)	(%)
Hardwoods:					
Ash (White)	.60	3.8	6.2	1.6	2.6
Beech	.64	4.1	8.8	1.7	3.7
Hickory ²	.72	5.9	9.1	2.5	3.8
Maple (Sugar)	.63	3.9	7.6	1.6	3.2
Oak (Red)	.63	3.2	6.6	1.3	2.7
Oak (White)	.68	4.2	7.2	1.8	3.0
Sweetgum	.52	4.2	7.9	1.7	3.3
Blackgum (Tupelo)	.50	3.5	6.2	1.5	2.6
Yellow-Poplar	.42	3.2	5.7	1.3	2.4
Softwoods:					
Douglas-fir					
Coast type	.48	4.0	6.2	1.7	2.6
Intermediate	--	3.3	6.1	1.4	2.5
Rocky Mountain	--	2.9	5.0	1.2	2.1
Fir					
Pacific silver	.43	3.7	7.8	1.5	3.3
White	.39	2.6	5.7	1.1	2.4
Western Hemlock	.45	3.4	6.3	1.4	2.6
Pine					
Eastern White	.35	1.8	4.8	.8	2.0
Southern Yellow ²	.55	4.0	6.1	1.7	2.6

¹Oven-dry weight and volume at 12 percent moisture content.

²Average of four major species.

TABLE 2-3

Classification of Species with Respect to Heartwood Permeability

Softwoods	Hardwoods
Group 1. Heartwood Easily Penetrated	
Bristlecone pine Pinon pine Ponderosa pine	Basswood Beech (white heartwood) Black gum Green ash, Pin cherry River birch, Red oaks Slippery elm, Sweet birch Tupelo gum, White ash
Group 2. Heartwood Moderately Difficult to Penetrate	
Douglas-fir (Pacific-coast type) Jack pine Loblolly pine Longleaf pine Norway pine Shortleaf pine Western hemlock	Black willow Chestnut oak Cottonwood Largetooth aspen Mockernut hickory Silver maple Sugar maple Yellow birch
Group 3. Heartwood Difficult to Penetrate	
Eastern hemlock Engelmann spruce Lowland white fir Lodgepole pine, Noble fir Sitka spruce, Western larch White fir, White spruce	Hackberry Rock elm Sycamore
Group 4. Heartwood Very Difficult to Penetrate	
Alpine fir Corkbark fir Douglas-fir (Intermountain type) Northern white cedar Tamarack Western redcedar	Beech (red heartwood) Black locus Chestnut Redgum White oaks (except chestnut oak)

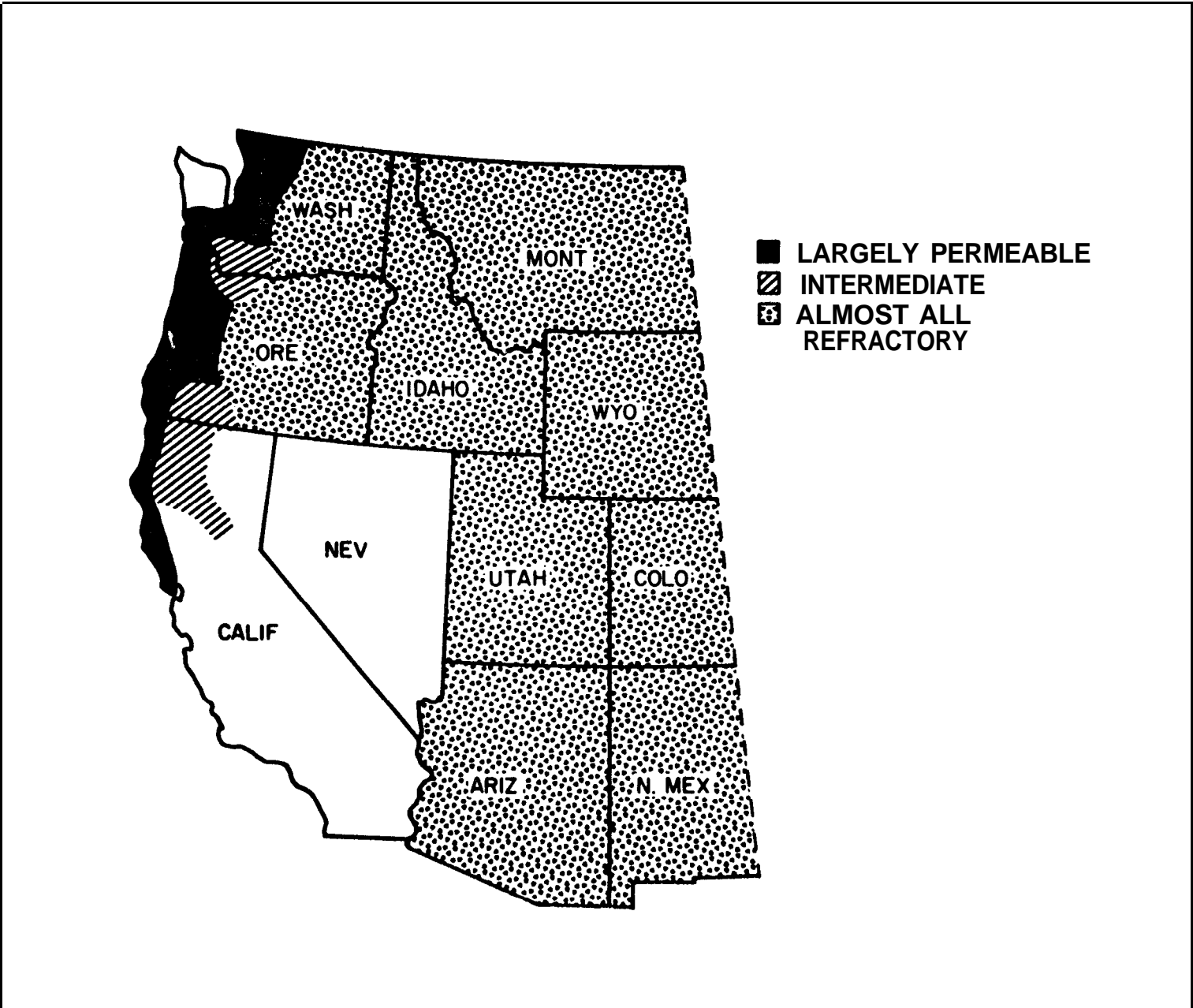

FIGURE 2-9
 Heartwood Permeability of Douglas-Fir
 by Geographic Location

2.4.3.1 Green Wood. Wood cut from a green log often contains as much or more than its oven-dry weight in the form of sap or water. The cell walls in green wood are fully saturated and swollen, and the cell cavities are partially to completely filled with water. Water in wood cell cavities is called free water.

2.4.3.2 Fiber Saturation Point. After wood has dried to about 30 percent moisture content, it is at the fiber saturation point. In this state, the cell cavities are emptied of free water, but the cell walls are still saturated and, thus, still in their weakest condition. At moisture contents above the fiber saturation point, wood can be attacked by decay fungi.

2.4.3.3 Bound Water. The water remaining in the cell walls after wood has dried to the fiber saturation point is called bound water. The bound water is held by physical forces of attraction within the cell walls. Just as a sponge shrinks and hardens as it dries, wood also shrinks as it dries below the fiber saturation point. Wood will not decay when only the bound water remains.

2.4.3.4 Equilibrium Moisture Content. Since wood is a hygroscopic material, the amount of water which the wood will lose depends on the relative humidity. That is, it responds to changes in atmospheric humidity and loses bound water as the relative humidity drops, regaining bound water as the relative humidity increases. For a given relative humidity level, a balance is eventually reached at which the wood is no longer gaining or losing moisture. When this balance of moisture exchange is established, the amount of bound water eventually contained in a piece of wood is called the equilibrium moisture content of the wood.

2.4.3.5 Shrinking and Swelling. Wood shrinks and swells due to the loss or gain of bound water from the cell walls. The amount of movement depends on the amount of water gained or lost, the orientation of the wood cells and species (Table 2-2).

Wood should be dried to its anticipated equilibrium moisture content after installation, to minimize problems (shrinking, swelling, checking and warping) due to changing moisture contents. Table 2-4 shows the recommended moisture content values for various wood items at the time of their installation.

Tangential shrinkage is generally 1.5 to 2 times that of the radial shrinkage. Since radial and tangential shrinkage is not equal, and because most boards contain some combination of the two grain patterns, warping will result if green lumber is allowed to dry without restraint. Warping includes cup, bow, twist, as well as diamonding, and crook (Figure 2-10). Round products such as poles, piles and posts develop surface checks and deep cracks for the same reason. Checks or cracks that penetrate the preservative shell on treated products provide entryways for decay fungi. Consequently, decay frequently is associated with cracks that go deep into the wood products. Therefore, when poles are inspected for internal decay, at least some borings should be taken in close proximity to cracks.

TABLE 2-4

Recommended Moisture Content Values for
Wood at Time of Installation

MOISTURE CONTENT FOR						
	Most Areas of United States		Dry Southwestern Areas		Damp, Warm Coastal Areas	
	Average Range		Average Range		Average Range	
	Percent		Percent		Percent	
Interior:						
Woodwork, flooring, 8	6-10		6	4-9	11	8-13
furniture, wood						
trim, laminated						
timbers, cold						
press plywood						
Exterior:						
Siding, wood trim,	12	9-14	9	7-12	12	9-14
framing, sheathing,						
laminated timbers						

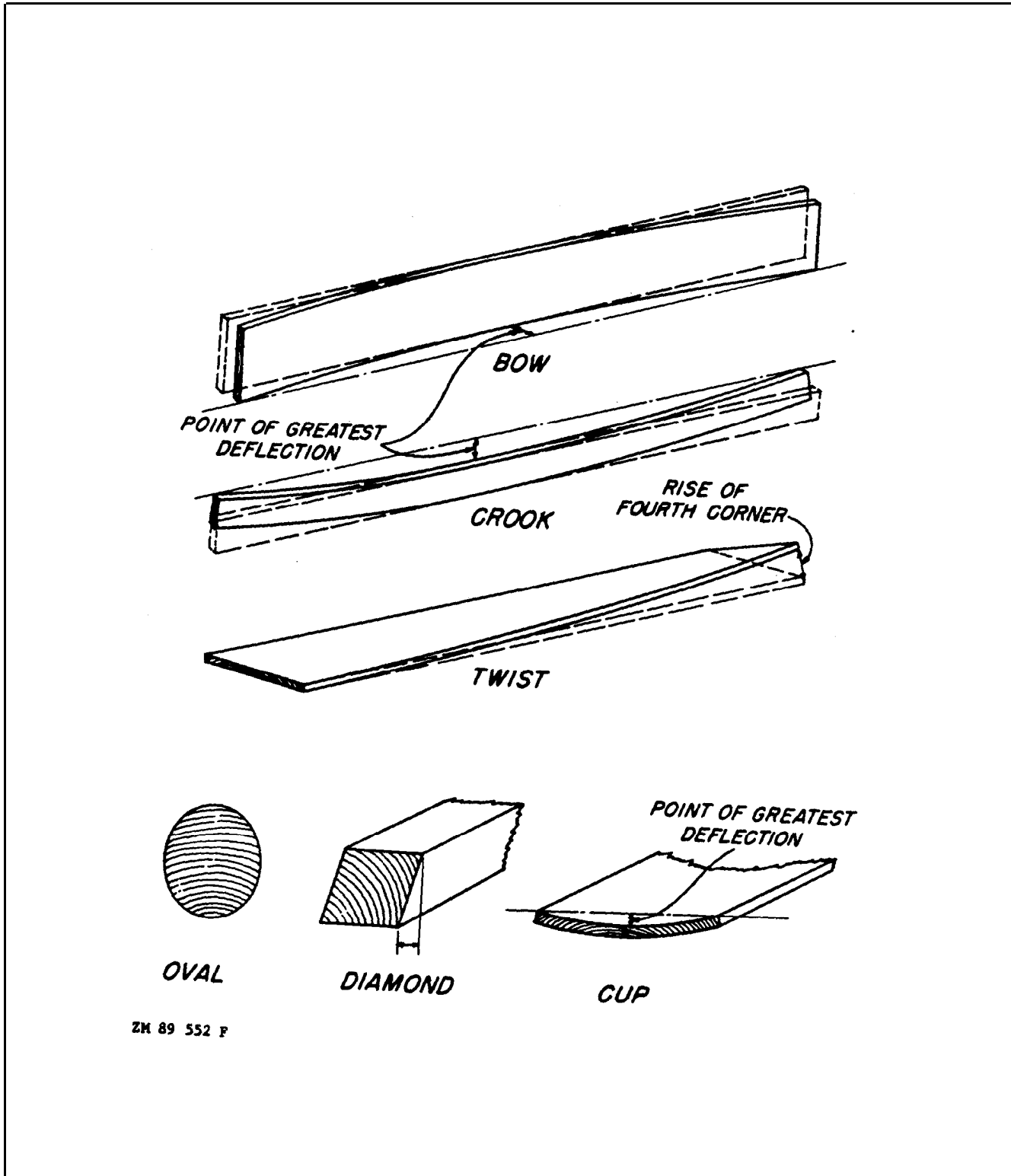

FIGURE 2-10
Various Types of Warp

Shrinkage of normal wood in the longitudinal direction is usually about 0.1 percent and considered insignificant.

2.4.4 Wood Drying Process. As lumber dries, a moisture gradient is set up because the shell (wood near the surface of the board) and the core of the board dry at different rates. If this moisture gradient becomes too steep, serious defects can develop.

In kiln drying of lumber, the moisture gradient is controlled so the wood will dry rapidly without developing serious defects.

2.4.5 Weathering. The natural weathering process results from a complex combination of chemical, mechanical, biological, and light-induced changes. In general, within two months of exposure to sunlight, freshly cut woods begin to change color. Light-colored woods generally become darker, while dark-colored woods become lighter. Subsequently, surface checks, then cracks, may develop and the wood becomes gray.

The gray color of the surface layer of weathered wood usually results from growth of dark-colored fungi. A silvery cast or the bleaching of dark woods exposed to sunlight results from degradation of the dark colored lignin, but not the cellulose (which is white) on wood surfaces. After prolonged exposure to sunlight, surfaces of unpainted wood will have a covering of loose, white cellulose fibers. If wood is repeatedly wetted and dried, boards may cup and warp and wood surfaces may become friable, with fragments separating from the surface.

Wood treated with an oil based preservative will weather at a slower rate than untreated wood. Wood treated with water borne salts, such as chromated copper arsenate, will slowly weather to a light gray color. There is some indication that preservatives which contain chromium will also reduce the degrading effect of sunlight.

2.5 MECHANICAL PROPERTIES. Mechanical, or strength properties, refer to those characteristics which an architect or engineer uses in the design of a structure (utility line, wharf, bridge, housed etc.). These properties are expressed numerically, i.e., pounds per square inch (psi) The four most common ways in which any member of a structure can be loaded or stressed are: Tension--it may be stretched. Compression--it may be compressed. Bending--it may be bent as in a floor joist which is supported on a foundation at its ends and loaded along its length. Shear--it may be loaded such that one surface tries to slide past an adjoining surface.

A complicating factor arises with wood because it has different strength values across the grain than it has along the grain. Most species are four to five times as strong in compression along the grain as they are across the grain.

The question "How strong is one wood compared to another?" must be qualified by indicating how the wood will be used. It is important to recognize which mechanical properties should be con-

sidered since a wood which is relatively strong with respect to one strength property may be weaker in a different property when compared to another species.

2.5.1 Modulus Of Elasticity. Stiffness is an important property of wood members that should not sag. The Modulus of Elasticity (MOE or E) is a measure of stiffness or rigidity. Figure 2-11 presents the MOE values for a number of species, as well as the allowable design values. Allowable design values are keyed to an average MOE value without reduction for property variability because stiffness is most important from an appearance standpoint and not from the point of life safety. That is, the member, if not properly designed, could sag or otherwise deflect without physically hurting someone.

2.5.2 Modulus Of Rupture. The Modulus of Rupture (MOR) is the measure of the ability of a beam to support an applied load. Since the modulus of rupture represents the point at which a beam will fail, it is considered a life endangering property and the allowable design values (Figure 2-12) are substantially reduced from those given for small clear wood specimens.

2.5.3 Compression Strength. Compression strength is a measure of the resistance of wood to being crushed. A common example of where compression strength along the grain is utilized occurs in studs in house walls. The studs, usually 2x4's, hold up the roof with any snow or wind loads that may arise and are loaded in compression parallel to the grain. Tie plates on railroad ties exert a compression force perpendicular to the grain. If extremely light or soft wood species were used for ties and with heavy railroad traffic, the weight of the trains, borne on the plates, would literally crush the wood.

2.5.4 Tensile Strength. Tensile strength is basically the opposite of compression strength. In this case, the load is applied in such a way that the wood member is being pulled from end to end (tension parallel to the grain) or across the grain (tension perpendicular to the grain).

2.5.5 Shear. The shear strength of a member parallel to the grain is a measure of the ability of wood to resist the slipping of one part along another. Shear failure is important in beam design. Shear strength, like modulus of rupture, is a life endangering property. Consequently, substantial differences exist between the allowable design values, and those for small clear wood specimens (Figure 2-13)

2.5.6 Side Hardness. Side hardness relates to the ability of wood to resist denting. One example includes flooring.

2.5.7 Toughness. Toughness is a measure of the amount of work expended in breaking a small specimen by impact bending. This property is important when impact loads are applied. Toughness is reduced by the early stages of decay and even stain fungi.

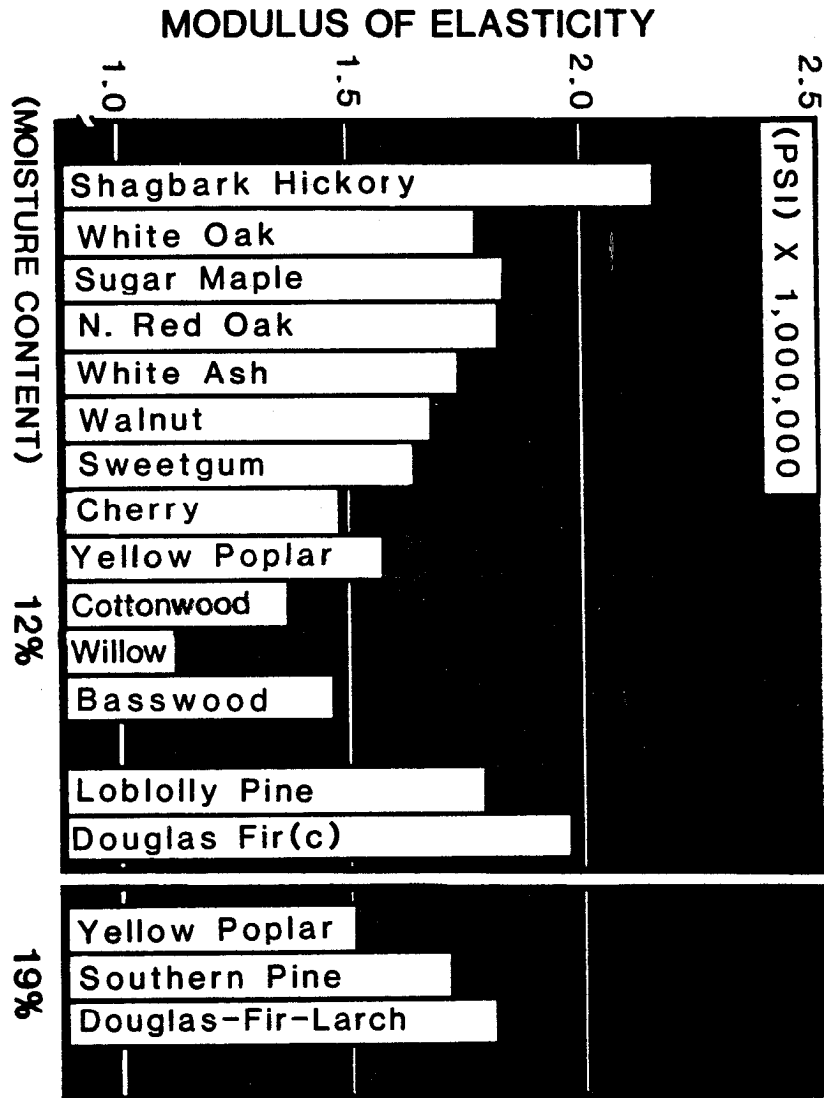

FIGURE 2-11
 Modulus of Elasticity at 12% Moisture Content and Allowable Design Values for Select Species at 19% Moisture Content

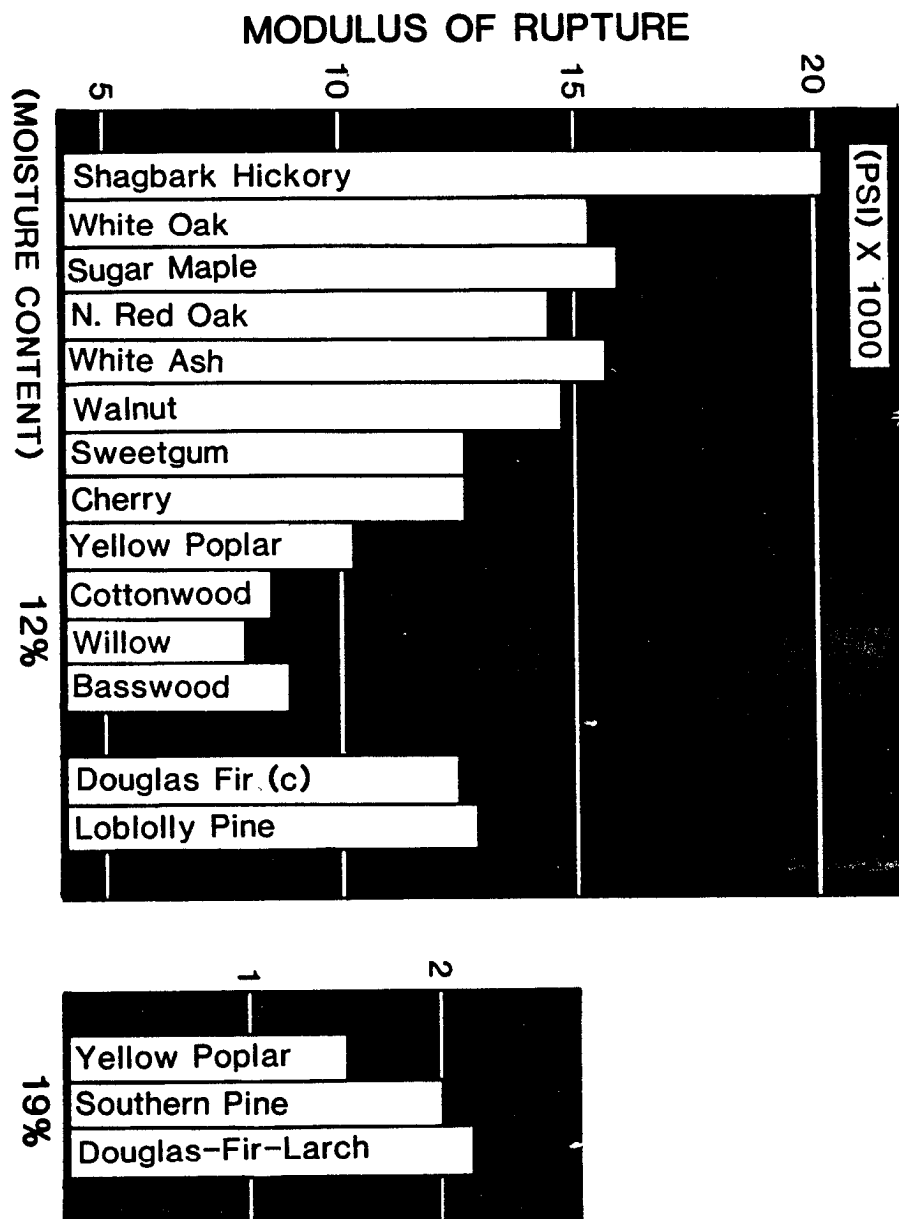

FIGURE 2-12
 Modulus of Rupture at 12% Moisture Content and Allowable
 Design Values for Select Species at 19% Moisture Content

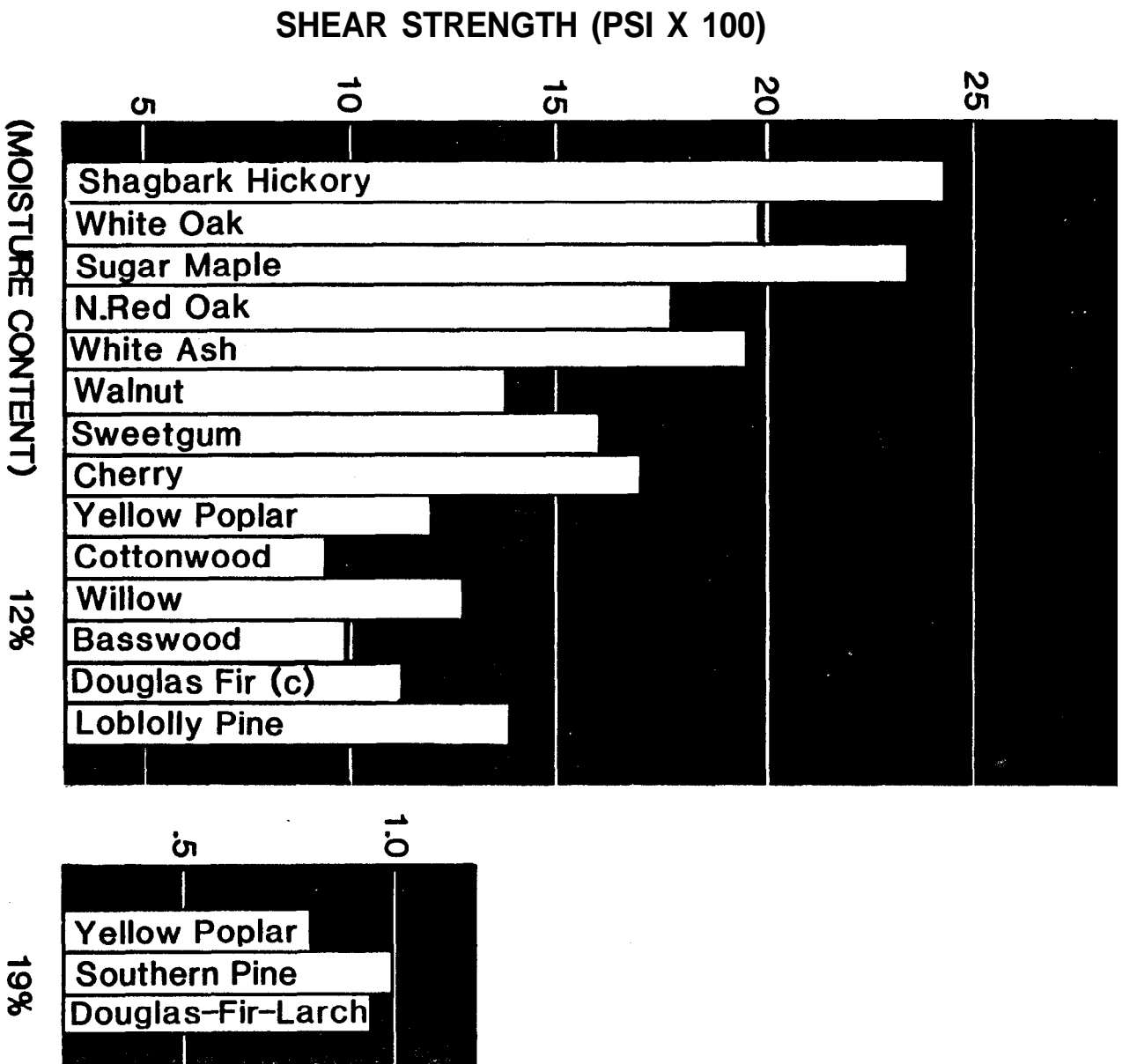

FIGURE 2-13
 Shear Strength at 12% Moisture Content and Allowable
 Design Values for Select Species at 19% Moisture Content

2.6 STRENGTH AFFECTING CHARACTERISTICS. Grading rules and materials standards for wood products to be treated exclude or set maximum allowable limits for certain anatomical characteristics and defects that reduce wood strength. Thus, it is important to be cognizant of those features which could detract from the total performance of the treated wood product if they were not detected during the inspection process. A few of the more important terms which are not discussed elsewhere are given below. Additional definitions are provided in most standards and by the American Society For Testing and Materials.

2.6.1 Abnormal Wood. In both hardwoods and softwoods, depending on age and location in the tree, some wood is found which is not representative for that species. This wood is called abnormal wood. Its strength properties are significantly lower than that of normal wood, therefore, the amount of abnormal wood in a structural product is usually limited.

2.6.1.1 Juvenile Wood. Juvenile wood is that material formed near the center or pith of the tree, and is prevalent in the softwoods or conifers and it also occurs in hardwoods. Juvenile wood is characterized by wide growth rings with shorter, thin-walled cells, and fewer latewood cells, thus resulting in a lower density and reduced strength values. There is also a tendency towards greater spiral grain. The shrinkage characteristics of juvenile wood are also different from those of normal wood, thus increasing warp problems. When drying, the wood often checks across the grain (Figure 2-14). The change from juvenile wood to normal wood is gradual, thus making identification of juvenile wood difficult.

2.6.1.2 Reaction Wood. Reaction wood forms in leaning or bent trees and is an attempt by the tree to straighten itself out.

Compression Wood. In softwoods, reaction wood is called compression wood. It is formed on the lower side of leaning trees. The part of the growth ring with reaction wood is usually wider than the rest of the ring, has a high proportion of latewood, and as a result the tree develops an eccentrically shaped stem and the pith is not centered. Compression wood, especially the latewood, is usually duller and more lifeless in appearance (Figure 2-14). It presents serious problems in wood manufacturing since it is much lower in strength than normal wood of the same density. Also, it tends to shrink excessively in the longitudinal direction causing cross grain checking. Compression wood is the cause of shelling in poles and piles (Figure 2-15). It is sometimes the cause of structural failures in critical applications, such as ladders. The softwood lumber grading rules restrict the extent of compression wood in lumber. Specifications and standards for wood poles usually require that the outer one inch of all poles be free from compression wood visible on either end.

Tension Wood. In hardwood trees, reaction wood is called tension wood and forms predominately toward the upper side of the leaning tree. Tension wood is usually not as evident as compression wood. It may form irregularly around the entire stem and, as a result, there is less tendency for the pith to be off center. Tension wood is often difficult to detect. It may

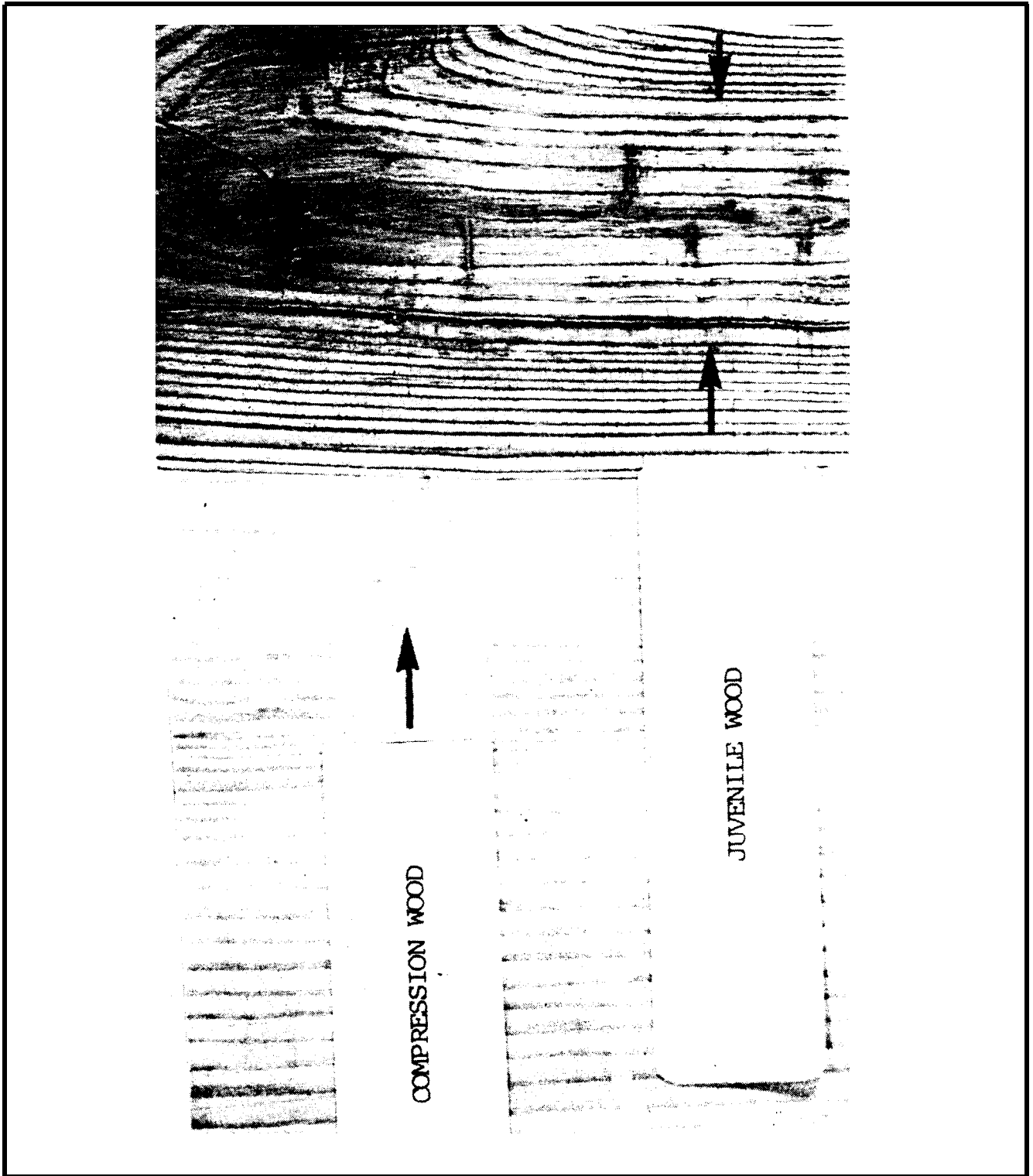

FIGURE 2-14

Juvenile Wood with Cross Grain Checking and
Compression Wood in Ponderosa Pine

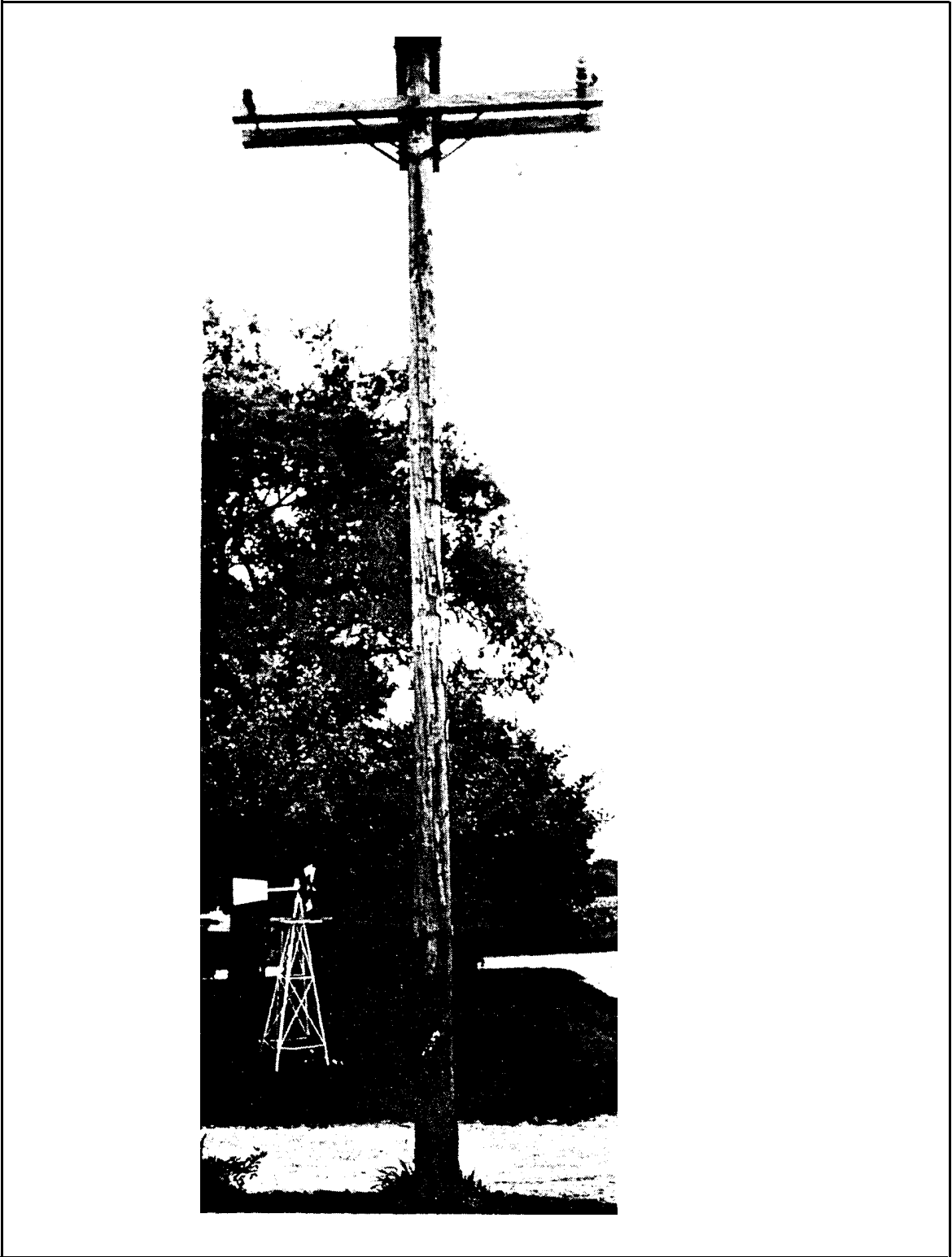

FIGURE 2-15
“Shelling” from Compression Wood in a
Southern Pine Utility Pole

have a silvery appearance and at other times cannot be visually detected. When machined, a fuzzy or woolly surface may result, particularly in green wood. Stain is sometimes absorbed irregularly by tension wood during the finishing process, leaving a blotchy appearance. Warping is also a problem with tension wood due to abnormal longitudinal shrinkage and during drying collapse often results. The strength properties of tension wood are generally less than for normal wood.

2.6.1.3 Spiral Grain. In some cases, the cells may be arranged in a noticeable spiral about the stem. In normal wood, the longitudinal cells are almost parallel to the main axis of the tree stem; with spiral grain, the cells are at a much flatter angle. Poles and piles produced from these trees, or lumber sawn from these logs, will have a cross or diagonal grain pattern. These wood products are typically low in strength and stiffness, and tend to twist upon drying. Standards for poles, limit the amount of spiral grain that can be accepted.

2.6.1.4 Knots. A knot is that portion of a branch or limb which has been surrounded by subsequent growth of the tree. As a knot appears on the cut surface it is merely a section of the entire knot, its shape depending upon the direction of the cut. The number, shape, size and location of knots in respect to the geometry of the wood member can affect the strength, and, thus, the grade of structural products. The method in which the knot size is determined is precisely defined for structural products.

2.6.2 Anatomical Disruptions. Wood is produced in the tree as an internally contiguous tissue, but forces acting on trees or products frequently cause disruptions in this tissue. These internal disruptions can reduce wood strength.

2.6.2.1 Shake. Shake is the longitudinal separation of the wood. Two forms of shake are recognized. Heart shake is that which starts out at or near the pith and extends radially. It is also called heart crack or rift crack. A heart shake in which several radial cracks are present is termed a star shake. Ring shake is concentric with the growth rings. It may partially or completely encircle the pith, occasionally moving radially to an adjacent growth increment. It is also called cup shake.

2.6.2.2 Split. Split is the separation of the wood parallel to the fiber direction, due to the tearing apart of the wood cells. It most often occurs on the ends of a wood member as it dries.

2.6.2.3 Compression Failure. Compression failure is the deformation of the wood fibers resulting from excessive compression along the grain either in direct end compression or in bending. It may develop in standing trees due to bending by wind or snow or to internal longitudinal stresses developed during growth, or it may result from stresses imposed after the tree is cut. In surfaced lumber, compression failures appear as fine wrinkles across the face of the piece.

2.6.2.4 Cross Break. A cross break is the failure of the wood cells across the grain and severely reduces wood strength. Such breaks may be due to internal stress resulting from unequal longitudinal shrinkage, such as that which occurs in compression wood or from external forces. Cross breaks are often masked by preservative treatment. Thus, inspection of poles “in the white” prior to treatment is important.

CHAPTER 3. WOOD IDENTIFICATION

Accurate identification of wood is an important component of the procurement process because of the wide variation in physical and mechanical properties and value between species. A most obvious application is the assurance that the species specified and paid for is received. This chapter will describe features which can be used to identify wood species that are frequently used by the U.S. Navy. Most utility poles and marine piling are either Douglas-fir or southern pine. Construction lumber and timbers are mostly southern pine, Douglas-fir, western hemlock or white fir. Oaks and gums are commonly used in railroad ties. Pines and Douglas-fir are sometimes used for ties.

3.1 SPECIES SEPARATION. The identification of wood is a science and art. This section discusses the gross characteristics which can be used to separate common species. Only a few species are discussed, and the use of gross characteristics is by no means foolproof. These characteristics are summarized in Table 3-1. For accurate determination, professional help should be consulted.

The first step in wood identification is the separation of the softwoods from the hardwoods. The differences are discussed in Chapter 2. Softwoods have a more uniform, simpler cell structure than the hardwoods. The two groups are seldom mixed in a shipment.

Figure 3-1 shows flat gram samples of four major softwoods: Douglas-fir, southern yellow pine, western hemlock, and white fir. Douglas-fir and southern yellow pine both have a coarse gram pattern which is caused by the abrupt transition between earlywood and latewood (Figures 2-1 and 2-2). Douglas-fir is predominately heartwood and has an orange-red to red or sometimes yellowish color with a very distinctive resinous odor when freshly cut. Southern yellow pine, by contrast, is predominately light colored sapwood. Some larger pieces, or those cut from the very center of the tree, will have heartwood similar in color to that of Douglas-fir. Both species are moderately heavy. Resin canals are present in both species, but they are more pronounced and common in pine and appear as white streaks in the latewood (Figure 2-2).

Western hemlock and white fir, by contrast, have a more uniform gram pattern which does not show wide variations between earlywood and latewood. The heartwood of hemlock is light reddish-brown with a purplish cast, especially in the summerwood bands, as compared to white fir which is nearly white to pale reddish-brown. Both species lack resin canals, and are lighter in weight than Douglas-fir and southern yellow pine.

Figure 3-2 shows flat gram samples of four major hardwoods; white oak, red oak, sweetgum and black gum. White and red oak are both ring porous woods, and thus have a very distinctive coarse gram pattern on the flat surface. Red oak is usually coarser textured than white because it is often faster growing and does not have its pores or vessels plugged with tyloses. Also, on a clean cut end grain surface, the pores of red oak appear open and those of white oak are closed by tyloses. White oak heartwood is light to dark brown, while red oak has a distinctive pinkish or pale reddish cast. Both woods have distinctive rays (Figure 2-4), are straight grained and heavy in weight.

Species	Grain Characteristics	Heartwood Color	Weight	Additional Factors ^{1/}
<u>SOFTWOODS</u>				
Douglas-fir DF ^{2/}	Coarse, abrupt transition between earlywood and latewood	Orange-red to red to sometimes yellowish	Moderately heavy	Present, not distinct
Southern Yellow Pine SP	Same as Douglas-fir	Heartwood limited-same as Douglas-fir; sapwood common, white to yellowish	Moderately heavy	Present, distinct
Western Hemlock WH	Mostly uniform, some contrast between earlywood and latewood	Light reddish-brown with a purplish cast in latewood bands	Moderately light	Absent
White Fir WF	Uniform	Nearly white to pale reddish-brown	Light	Absent
<u>HARDWOODS</u>				
White Oak OA	Coarse, ring porous, straight grained	Light to dark brown	Heavy	Conspicuous
Red Oak OA	Coarse, ring porous, pores more open than white oak, straight grained	Pinkish to pale reddish cast	Heavy	Conspicuous
Black Gum GU	Fine, diffuse porous, interlocked grained	Heartwood reddish-brown sapwood common, pale flesh color with pinkish tinge or discolored with blue stain; variegated pattern common between sapwood and heartwood	Moderately heavy	Inconspicuous
Black Gum GU	Fine, diffuse porous, interlocked grained	Heartwood greenish to brownish-gray; sapwood common, white to grayish	Moderately heavy	Inconspicuous

^{1/}Additional factors are resin canals for softwoods and wood rays for the hardwoods.

^{2/}Species brand abbreviations are those used by the American Wood Preservers' Association.

Gross Characteristics for Selected Softwood and Hardwood Species

TABLE 3-1

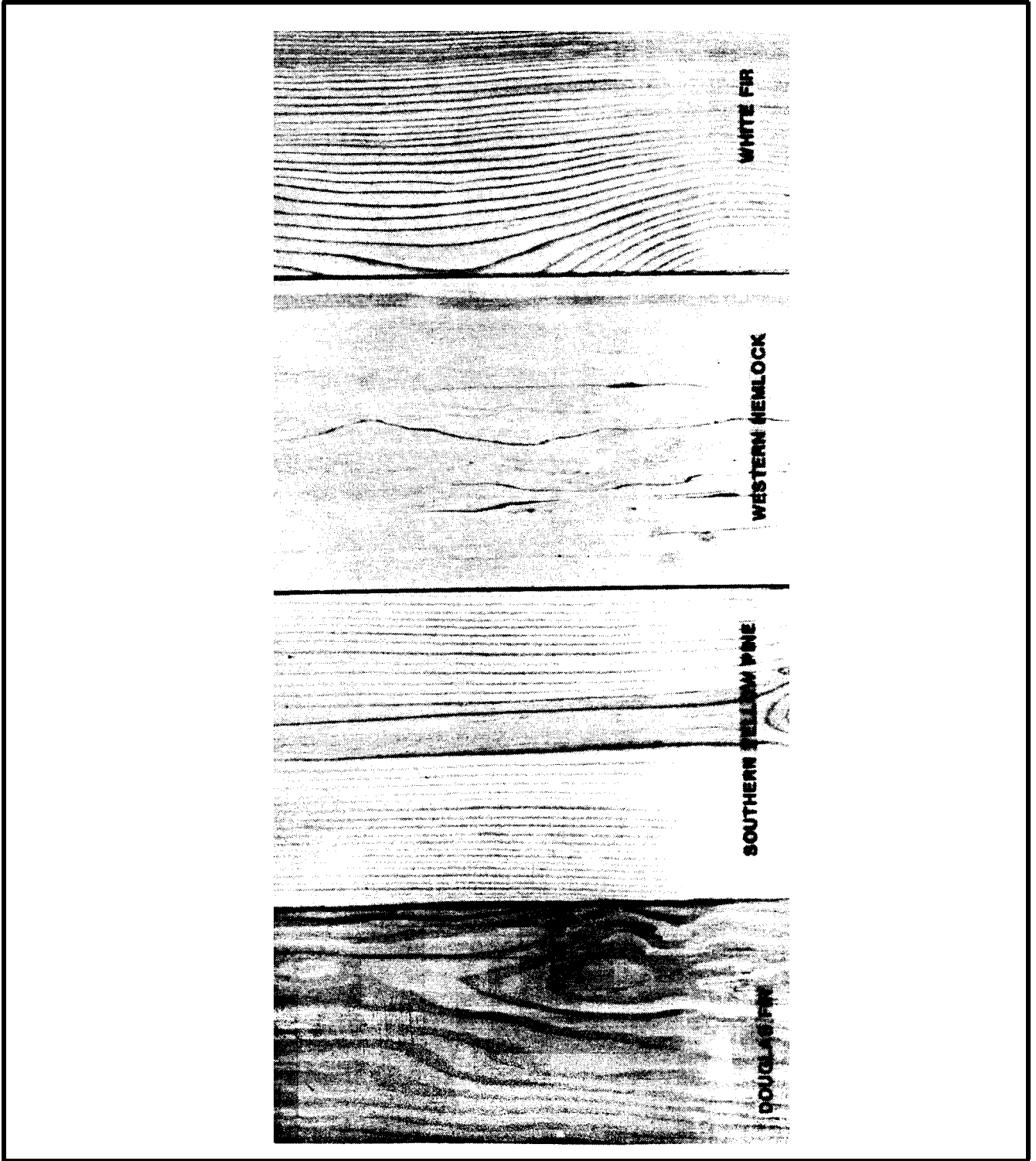

FIGURE 3-1

Douglas-Fir, Southern Yellow Pine, Western Hemlock, and White Fir (from left to right) are Four Major Softwood Species (note the Narrow Band of Heartwood in the Center of the Southern Yellow Pine Sample)

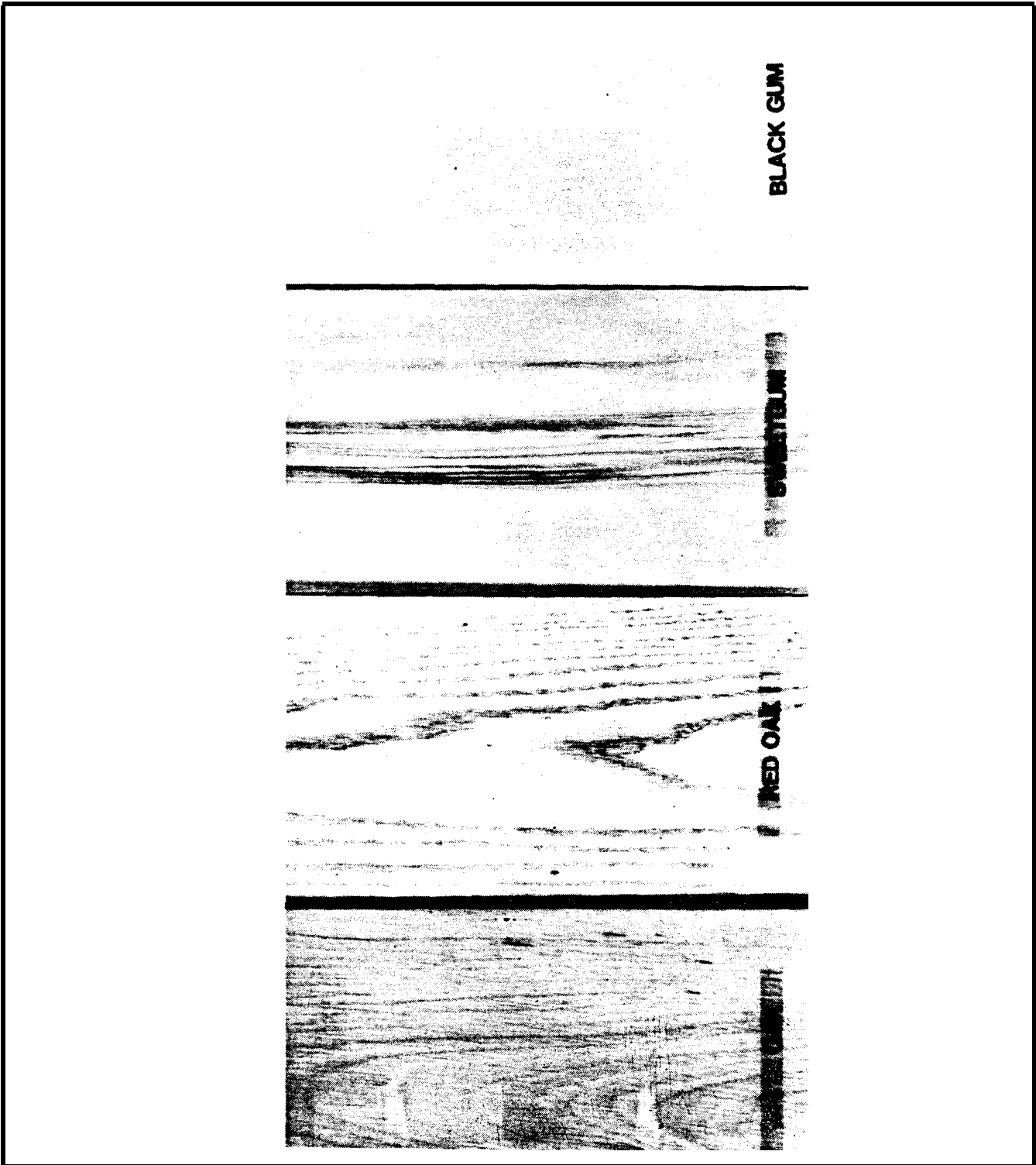

FIGURE 3-2
White Oak, Red Oak, Sweetgum and Black Gum (from left to right) are
Four Major Hardwood Species (Note the Course Texture of the Oaks,
Especially Red Oak and the Variegated Pattern in Sweetgum)

Sweetgum and black gum, in contrast to the oaks, are diffuse porous woods and do not show a distinctive grain pattern. Sweetgum heartwood has a reddish-brown color. The sapwood is a pale flesh color and frequently has a pinkish tinge or is discolored with blue stain. The transition zone between heartwood and sapwood is sometimes variegated (Figure 3-2). Black gum, by contrast, has a white to grayish white sapwood which merges gradually into the darker, greenish or brownish-gray heartwood. Both species lack distinctive rays as compared to the oaks, have interlocked grain and are moderately heavy in weight.

An easy-to-use chemical test separates white oak from red oak. When a ten percent solution of sodium nitrite (NaNO_2) is either brushed or sprayed on freshly cut sound heartwood, the heartwood of white oak turns yellow-orange, then red-brown, and then dark green or purple to black while the red oak heartwood is just slightly darkened.

Sodium nitrite is available from chemical supply stores. A 10 percent solution is prepared by mixing 3.34 ounces per quart (104 grams per liter) of either tap or distilled water. The solution remains effective for several months. At 80°F the color reaction takes place in about 5 minutes. The reaction time decreases as the temperature is lowered. At 50°F the rate is about 20 minutes, and below freezing, almost 24 hours. In cold weather 20 percent ethylene glycol can be added to the sodium nitrite solution to prevent freezing. The solution can be heated to 194 degrees fahrenheit, or the localized area of the wood heated to accelerate the reaction. The test will work on wood with a moisture content ranging from green to six percent. In green or fresh material, the reaction time is faster; the yellow, orange, and red shades seem more brilliant; and the color sequence is more distinct.

3.2 SPECIES DESCRIPTIONS DETAILED. The detailed descriptions for selected species are given below.

3.2.1 Softwoods. Softwoods refer to those tree species called conifers or evergreens, as described in Chapter 2. They are commonly used for poles, piling and construction lumber and timbers. Anatomically, softwoods are characterized by tracheids. Tracheids are large, slender, lightweight cells which add greatly to the strength of wood. Figure 3-1 shows four of the five domestic species discussed below.

3.2.1.1 Douglas-fir. Douglas-fir (*Pseudotsuga menziesii*) grows in most forests from the Rocky Mountains to the Pacific coast, and from the Mexican border north through Canada. The permeability, physical and mechanical properties of Douglas-fir vary with geographic location (Figure 2-9 and Table 2-2). Botanically, it is not a true fir. It reaches its largest size and fastest rate of growth in Washington and Oregon, where large trees form very dense forests.

Most old growth Douglas-fir from the Pacific coast and northern Rocky Mountain states is moderately heavy, very stiff, moderately strong, and moderately shock resistant. It weighs about 33 pounds per cubic foot (air-dried condition) and the average specific gravity (oven-dry weight and volume at 12 percent moisture content) of the coast type is 0.48. The wood is also moderately hard.

Most of the old growth Douglas-fir has been used and the second growth wood is now predominate. Wide ringed second growth Douglas-fir from the coastal states and material grown in the southern Rocky Mountain states tends to be lighter in weight and to have lower strength properties.

The heartwood is orange red to red or sometimes yellowish. The resin canals, which are seen as brownish streaks in the latewood, appear somewhat abundant and detectable. The transition from earlywood to latewood is abrupt. The heartwood of Douglas-fir may be confused with that of the southern yellow pines, but resin canals are larger and much more abundant in southern pine. Most Douglas-fir has a distinctive odor.

3.2.1.2 Western Hemlock. Western hemlock (*Tsuga heterophylla*) grows along the Pacific coast from Alaska to the San Francisco Bay, and as far inland as northern Idaho and northwestern Montana. The best stands are found in the humid coastal regions of Oregon, Washington, and Alaska and on the lower slopes of the Cascade Mountains in Washington and Oregon.

Western hemlock is moderately light in weight, averaging 29 pounds a cubic foot, and moderately hard, with a specific gravity of 0.45. It is also moderately weak and its shock resistance is fairly low. Although western hemlock has moderately large shrinkage, it is comparatively easy to season. The heartwood is low in decay resistance, but the wood is easy to work with tools and it has satisfactory gluing properties.

The heartwood of western hemlock is light reddish-brown and frequently has a purplish cast, especially in the latewood bands. Transition from earlywood to latewood is gradual and on the end-grained surfaces there is little color contrast between the two zones. The wood lacks normal resin canals.

3.2.1.3 White Fir. Commercial white fir includes white fir (*Abies concolor*), grand fir (*A. grandis*), Pacific silver fir (*A. amabilis*), California red fir (*A. magnifica*), and noble fir (*A. procera*). The species grow throughout the Pacific Coast and Rocky Mountain states. The largest stands of white fir (*A. concolor*) probably occur in California, but other states contain larger stands of the other species.

White fir is light in weight, the various species ranging from 26 to 28 pounds per cubic foot. It is moderately soft, with an average specific gravity of 0.41, moderately weak, moderately low in shock resistance, moderately stiff, and low in nail-withdrawal resistance. It is difficult to season, a fact that retarded its use until satisfactory seasoning methods were developed. Also, its decay resistance is low, but gluing properties are satisfactory.

The heartwood is nearly white to pale reddish-brown and the wood lacks normal resin canals. Transition from earlywood is more abrupt than in western hemlock. Also, more contrast occurs in the color between earlywood and latewood on the end-grain surfaces than in western hemlock. Wood

rays of the western firs frequently contain colored material that makes them stand out more on edge-grain surfaces.

3.2.1.4 Southern Yellow Pine. The southern yellow pine group (*Pinus* sp.) is composed of ten different species. Four species, loblolly (*Pinus taeda*), shortleaf (*P. enchinata*), longleaf (*P. palustris*), and slash (*P. elliottii*), make up 90 percent of the total timber inventory. Other species include spruce pine (*P. glabra*), Virginia pine (*P. virginiana*), sand pine (*P. clausa*), pitch pine (*P. rigida*), pond pine (*P. serotina*) and table mountain pine (*P. pungens*). The wood of all southern pines is similar and individual species cannot be reliably separated. This group ranges throughout the southeast from eastern Texas to the east coast and northward to Missouri and east to southern Indiana, Pennsylvania, Maryland and Delaware.

Southern yellow pine is a moderately heavy wood with a typical weight ranging from 36 to 44 pounds per cubic foot. The average specific gravity for the four major species is 0.55. Typically, the wood is moderately hard, moderately strong, stiff, and moderately shock resistant. The heartwood, which constitutes only a very small portion of the current timber supply, is moderately decay resistant.

The heartwood color ranges from shades of yellow and orange to reddish-brown or light brown. The transition from earlywood to latewood is abrupt, with the annual rings prominent on all surfaces. Resin canals are large and abundant and are easily found in all growth increments. Considerable variation in ring width due to growth conditions occurs; the faster growth wood being less strong.

3.2.1.5 Miscellaneous Yellow Pines. Several species of yellow pine either grow or have been planted in Central and South America, Australia and New Zealand. These species include radiata or Monterey Pine (*Pinus radiata*), Caribbean Pine (*Pinus Caribaea*) and others. The woods of these species cannot be separated from the southern yellow pines produced in the United States. Some of the trees in this group, depending on geographic location and other factors, have a fast growth rate. A fast growth rate will reduce the strength properties and some caution should be exercised in accepting this wood when it is not graded for strength.

3.2.2 Hardwoods. Hardwoods refer to those tree species which generally, but do not always, have broad deciduous leaves as described in Chapter 2. These leaves change color and drop to the ground each fall. Figure 3-2 shows four of the five species or species groups discussed below.

3.2.2.1 Red Oak. The red oak group (*Quercus* sp.) includes northern red oak (*Quercus rubra*), black oak (*Q. velutina*), scarlet oak (*Q. coccinea*), shumard oak (*Q. shumardii*), pin oak (*Q. palustris*), Nuttall oak (*Q. nuttallii*), southern red oak (*Q. falcata*), water oak (*Q. nigra*), laurel oak (*Q. laurifolia*), and willow oak (*Q. phellos*). Red oaks range east of the Great Plains except for a narrow coastal strip along the Gulf of Mexico and in Florida.

Red oak averages 44 pounds per cubic foot and the average specific gravity is 0.63. The wood is

hard, stiff, and has a high shock resistance. Because it lacks tyloses in its pores, it is extremely porous and thus will accept preservative treatment.

The heartwood is grayish-brown with a distinctive reddish tint. The pores are open, and the outlines of the larger pores are distinct. On smoothly cut end grain surfaces, the latewood pores can be readily seen when examined with a hand lens. The wood rays are 1/4 to 1 inch high along the grain and can be seen without a hand lens (Figure 2-4). On end grain surfaces, rays appear as lighter colored lines crossing the growth rings.

3.2.2.2 White Oak. The white oak group (*Quercus* sp.) includes white oak (*Quercus alba*), chestnut oak (*Q. prinus*), post oak (*Q. stellata*), overcup oak (*Q. lyrata*), swamp chestnut oak (*Q. michauxii*), bur oak (*Q. macrocarpa*), chinkapin oak (*Q. muehlenbergii*), swamp white oak (*Q. bicolor*), and live oak (*Q. virginiana*). These species constitute the commercial white oaks and grow east of a line from western Minnesota to western Texas. Some minor species are found in Oregon, Washington, and California.

The white oaks are heavy woods, averaging 47 pounds per cubic foot, and are very hard, with a specific gravity of 0.68 for white oak to 0.81 for live oak. Led by live oak, they rank high in strength properties.

The pores of the heartwood, with the exception of chestnut oak, are plugged with tyloses--a froth-like growth that makes the wood impervious to liquids. The heartwood is resistant to decay. White oaks are above average in all machining operations except shaping.

The heartwood is grayish-brown. The outlines of the larger pores are indistinct except in chestnut oak, which has open pores. On smooth cut, end grain surfaces, the latewood pores are not individually distinct. Wood rays are generally higher than in red oak, the larger ones ranging from 1/2 to 5 inches in height along the grain. As in red oak, the rays appear lighter in color than the background wood on end-grain surfaces and darker than the background wood on side-grain surfaces.

3.2.2.3 Sweetgum. Sweetgum (*Liquidambar styraciflua*) grows from southwestern Connecticut westward almost to Kansas and southward to eastern Texas and central Florida. The commercial range in the United States is confined largely to the moist lands of the lower Ohio and Mississippi basins and to the lowlands of the southeastern coast.

Sweetgum is a moderately heavy wood with an average weight of 36 pounds per cubic foot. The wood is hard, with a specific gravity of 0.52, moderately strong when used as a beam or post, moderately stiff, and has moderately high shock resistance.

Sweetgum has a very large shrinkage in drying, and the sapwood and heartwood require different drying processes. The heartwood has low to moderate decay resistance. In nail-holding ability and in ability to resist splitting by nails and screws, sweetgum is rated intermediate.

The heartwood is reddish-brown and occasionally variegated with streaks of darker color. The pores are small and visible only with magnification. The growth rings are usually indistinct or inconspicuous. The rays are visible on the quartersawed surfaces. Red gum is obtained chiefly from the heartwood of old mature trees and is in limited supply. Sap gum, obtained from the sapwood, is readily available.

3.2.2.4 Black Gum or Black Tupelo. Black tupelo (*Nyssa sylvatica*) grows in all states east of the Mississippi River and as far west as central Texas. In the northern and eastern parts of its range, it grows under a wide variety of conditions ranging from swamps to dry mountain sides, but in the south it is largely confined to well-drained locations. The largest commercial cuts of black tupelo lumber are made in the southeastern states.

A moderately heavy wood, black tupelo has an average weight of 35 pounds per cubic foot. It is rated as hard, with a specific gravity of 0.50, and the heartwood is low to moderate in resistance to decay. The wood is moderately weak when used as a beam or post, moderately limber, and moderately high in ability to resist shock.

The heartwood is pale to moderately dark brownish-gray or dirty gray. The pores are very small, as in sweetgum. The growth increments are generally inconspicuous to moderately distinct. The rays are visible on the quartersawed surfaces, but show up less prominently against the background color of the wood than the rays in sweetgum.

3.2.2.5 Water Tupelo, Tupelo Gum or Swamp Tupelo. This species group consists of *Nyssa sylvatica* var. *biflora* commonly known as swamp tupelo or swamp black gum, and *Nyssa aquatica* commonly known as water tupelo or tupelo gum.

Water tupelo is distributed in the coastal region from southeastern Virginia through the gulf states to Texas and northward in the Mississippi River region to southern Illinois. Its best development is found in the cypress swamps of Louisiana and southern Texas. This species group is typical of very wet sites.

The wood of water tupelo and black gum (as discussed above) is similar and it may be sold as distinct species or in mixtures. However, swamp tupelo and water tupelo are usually somewhat softer, lighter and more porous, with more crowded, slightly larger pores than black gum.

3.2.2.6 Mixed Hardwood Species. Sometimes, hardwoods are mixed together at the producer's discretion. This mixture may include low valued species unless specifically eliminated by the specifier. The buyer and seller should have a written agreement as to what is and is not acceptable regarding mixed hardwood species.

CHAPTER 4. WOOD DETERIORATION

Wood preservatives are used to prevent damage by bacteria, fungi, insects, marine borers and other agents described here. An understanding of these organisms and their damage will contribute to improved wood procurement and construction practices. The various characteristics are summarized for bacteria and fungi in Table 4-1, for termites and carpenter ants in Table 4-2, for wood boring insects in Table 4-3 and for marine borers in Table 4-4.

4.1 BACTERIA. Bacteria are minute one-celled organisms. A single drop of water may contain thousands of them.

The sapwood of all wood species appears susceptible; the heartwood less so, in both short and long term exposures of centuries. The earlywood may be decomposed more rapidly than the latewood.

Bacteria act slowly. Deterioration of wood products by bacteria occurs in wood, such as piles or wood slats in cooling towers, that is completely saturated or submerged in water for many years. Upon drying, the outer, degraded area develops a cross-checking that is particularly pronounced on the tangential face (Figure 4-1).

Bacteria are also known to increase the permeability of sapwood without a noticeable decrease in specific gravity.

4.2 FUNGI. Fungi are non-green, flowerless one cell to threadlike organisms that use wood and other plant materials as a food source.

Wood destroying fungi are composed of millions of microscopic thread-like structures called hyphae. Initially, individual hyphae develop from germinating spores and spread throughout the wood. The hyphae secrete enzymes which attack the wood cells, and finally cause the wood to disintegrate.

Fungi have four requirements for growth. These requirements are: a food source, oxygen, a favorable temperature and moisture.

Food - Since fungi are non-green plants, they cannot utilize sunlight to synthesize food materials. They require an already synthesized food source such as wood. Molds generally feed on material located on the wood surface while sapstains utilize food substances stored in the wood cells. The decay fungi utilize the wood cells themselves thus causing serious strength losses.

Air - All wood decaying fungi need a source of oxygen. Wood stored under water or deep in the soil does not decay because of the lack of oxygen.

Temperature - The best temperature for wood decay fungi is 75-90 degrees fahrenheit. Decay continues at a reduced rate or is even dormant at freezing or extremely high temperatures.

Comparison of Characteristics of Brown, Soft and White Rots,
Molds, Sapstains and Bacterial Infected Wood

TABLE 4-1

Characteristics	Bacterial Infected	Molds	Sapstains	Brown Rots	White Rots	Soft Rots
Preferred host	Sapwood and earlywood more susceptible than heartwood and latewood	Sapwood and heartwood surface of softwoods and hardwoods, sapwood preferred	Sapwood of both softwoods and hardwoods	Softwoods	Hardwoods	Softwoods and hardwoods
Color	Brownish, inner zones have been noted to be greenish	Black, green, orange or other shades	Blue to black, gray or brown, some red, purple or yellow	Initially lacks luster and appears dead, then abnormal brown color develops	Initially off-white, sometimes with black zone lines	Darkened, dull brown to blue gray
Surface characteristics	Softened on surface; cross checking develops when dry	Can be brushed or planed from surface; shallow staining may result in hardwoods	Discolored blue to black even when planed	Cross grain checking, collapse or crumbling, and abnormal shrinkage	Nearly normal until advanced stages, white fibrous mass results	Softened on surface; fine cracking and fissuring both with and across the grain when dry
Strength	Significant reductions in many properties with prolonged exposure	No serious effect except toughness	Only toughness reduced	Significant, rapid reduction in many properties	Gradual reduction except for toughness which is rapidly reduced	Significant in thin members
Other	Attacks water saturated or completely submerged wood	Can occur on air-dried wood when relative humidity exceeds 90 percent				Attacks surface of saturated wood

Characteristics	Subterranean Termites		Drywood Termites	Dampwood Termites ^{1/}	Carpenter Ants
	Native	Formosan			
Wood used for	Food	Food	Food	Food	Shelter
Moisture source or other conditions	Soil or other consistent supply of moisture required	Soil or other consistent supply of moisture required	No soil or moisture supply required	Damp or decayed wood required; soil or moisture supply not required	Damp or decayed wood preferred; will extend to dry, sound wood
Damage characterization	Shelter tubes present; earlywood preferred; with pale, spotted appearance like dried oatmeal on gallery walls	Shelter tubes present; earlywood preferred; with pale, spotted appearance like dried oatmeal on gallery walls	Piles of fecal pellets eliminated from kickholes in wood; infested wood with very thin surface; broad pockets with no regard for earlywood or latewood; galleries smooth without deposits	Damage in sound wood is similar to subterranean damage. In decayed wood, galleries are larger and pass through both earlywood and latewood; gallery walls with velvety appearance; some with dried fecal material	Galleries follow earlywood but will cut through latewood; gallery walls smooth and perfectly clean; "windows" or slit-like openings sometimes present on wood surface; sawdust-like frass and other debris present below windows
Insect description					
Swarms					
Size	1/3 - 1/2 inch	Up to 5.18 inch	1/2 - 5/8 inch	Up to 1 inch	Up to 3/4 inch
Color	Light tan to black	Yellow brown, larger than native subterranean	Slightly larger and lighter in color than subterranean	Yellowish brown to dark brown	Predominately black some reddish-brown to yellowish
Wings	Four equal sized; two prominent longitudinal veins et front edge	Like subterranean but with hairy wings	Several distinct longitudinal veins with many cross veins	Veins predominately on front edge of wings, more numerous than subterranean	Two pair, unequal size
Soldiers	Oblong, rectangular head	Oval-shaped head, exuded whitish, sticky substance		Very large, dark, rectangular head with large jaws	
waist	Not constricted	Not constricted	Not constricted	Not constricted	Very narrow, constricted
Other		Present in areas of TX, LA, SC and probably other southern coastal states; places carton in walls	Will attack small wooden articles such as furniture		











1/ Dampwood termites vary depending on species. This description is given for the Pacific coast species. the only one of economic importance.

Comparison of Characteristics for Termites and Carpenter Ants

TABLE 4-2

TABLE 4-3

Summary Table of Exit/Entry Hole Size, Type and Condition of Wood Attacked, Appearance of Frass and Potential for Reinfestation for Wood Boring Beetles and Carpenter Bees (To use the table, match the size and shape of the exit or entry holes in the wood to those shown in the table.)

Shape and site (inches) of exit/entry hole	Wood Type	Condition of Wood Attacked	Appearance of Frass in Tunnels	Insect Type	Reinfest
 Round 1/50-1/8	softwood & hardwood	unseasoned logs and lumber	none present	ambrosia beetles	no
 Round 1/32-1/16	hardwood	newly seasoned	fine, flour-like, loosely packed	lyctid beetles	yes
 Round or elongate 1/16-1/12	softwood & hardwood	slightly damp, decayed	very fine powder and tiny pellets, tightly packed	curculionids snout beetles or wood boring weevil	yes
 Round 1/16-3/32	bark/sapwood interface softwood & hardwood	unseasoned under bark only	fine to coarse, bark colored, tightly packed	bark or engraver beetles	no
 Round 1/16-1/8	softwood & hardwood	seasoned	fine powder and pellets, loosely packed (pellets may be absent and frass tightly packed in sane hardwoods)	anobiid beetles	yes
 Round 3/32-9/32	softwood & hardwood (bamboo)	seasoning and newly seasoned	fine to coarse powder, tightly packed	bostrichid beetles	rarely
 Round-oval 1/8-3/8	softwood & hardwood	unseasoned logs and lumber	coarse to fibrous, mostly absent	long-horned beetles or round-headed borers	no
 Oval 1/4-3/8	softwood	seasoning to seasoned	very fine powder & tiny pellets, tightly packed	cerambycids or old house borers	yes
 Oval 1/8-1/2	softwood & hardwood	seasoning	sawdust-like, tightly packed	buprestids or flat-headed borers	no
 Round 1/2	softwood	seasoned	none present	carpenter bee	yes
 Flat oval 1/2 or more or irregular surface groove 1/8-1/2 wide	softwood & hardwood	unseasoned logs and lumber or seasoning	absent or sawdust-like, coarse to fibrous; tightly packed	round or flat-headed borer, wood machined after attack	no

Characteristics	<u>Teredo</u> (Shipworms)	<u>Bankia</u> (Shipworms)	<u>Martesia</u> (Pholads)	<u>Limnoria</u> (Gribbles)	<u>Sphaeroma</u>
Appearance	worm like	see <u>Teredo</u>	clam like	louse like	see <u>Limnoria</u>
Borer size	length 1-2 ft. diameter 1/2 in.	length 5-6 ft. diameter 7/8 in	length 2 1/2 in. diameter 1 in.	length 1/8-1/4 in. 1/3 as wide	length 3/8-1/2 in. width 1/4 in.
Damage	entrance hole 1/16" diameter; surface damage minimal; subsurface severely honeycombed; holes lined with shelly calcareous deposits	see <u>Teredo</u>	Entrance hole 1/4" diameter; damage close to surface; 2-2 1/2 in. deep and 1 in. in diameter	Surface severely honeycombed, early-wood preferred; holes 1/6 in. diameter by 1/2 in. deep; wave action erodes pile surface to hourglass shape	Burrows typically 1/4 in. in diameter and about 3 times as deep, and perpendicular to the surface.
Area commonly attacked	mud line	see <u>Teredo</u>	--	between half and low tide, mud line	see <u>Limnoria</u>

Comparison of Characteristics of Marine Borers

TABLE 4-4

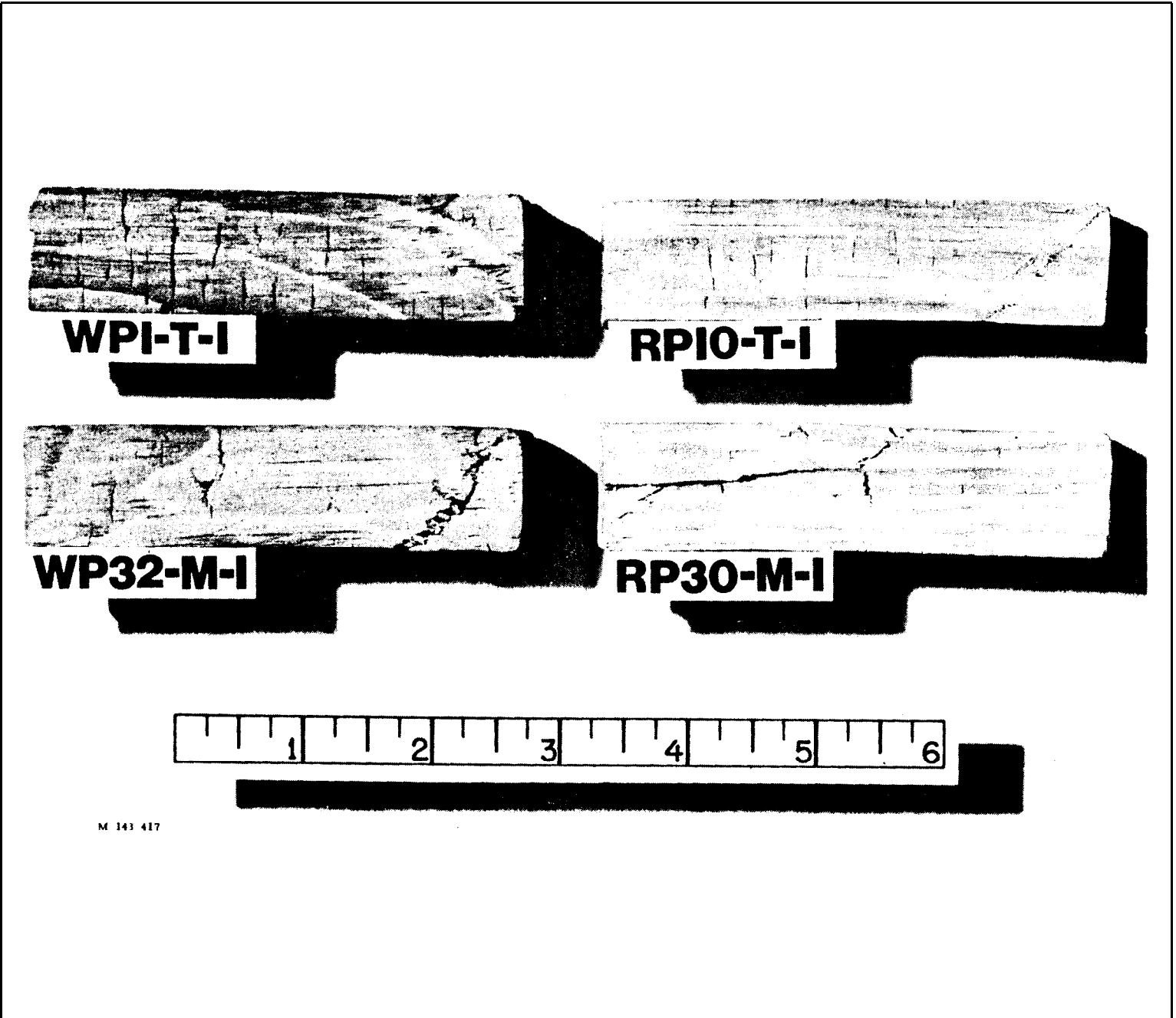

FIGURE 4-1

Bacterial Damage in Sapwood Cut from Untreated White Pine (left) and Red Pine (right) Piling Submerged for 85 Years in Freshwater

Moisture - For fungi to destroy wood, free water must be present in the cell cavities. Free water is usually found when the moisture content is 25 to 30 percent or higher. Decay stops at 20 percent or less moisture content. Thus, one effective way to control wood decay is to keep the moisture content of wood below 20 percent. Lumber properly installed in buildings has a moisture content of 8 to 15 percent, while that cut from freshly harvested trees may have a moisture content of well over 100 percent, based on the oven-dry weight of the wood. Wood in soil contact almost always has a moisture content of 20 percent or more.

4.2.1 Mold. Molds (Figure 4-2) discolor the surface of both hardwoods and softwoods. Molds are predominately different shades of green, black and occasionally orange or other light shades. Although the fungus hyphae does penetrate into the wood, the surface discoloration can generally be planed or even brushed off. On hardwoods some shallow staining may result. Strength other than toughness is not seriously affected by molds, but the permeability of the wood may be greatly increased.

Control measures include reducing the moisture content of wood to below 20 percent, or the use of approved fungicides applied as dips or sprays. It should be noted, however, that some molds can develop on air-dried wood with a moisture content in the 20 percent range if the relative humidity is 90 percent or more.

4.2.2 Sapstains.

4.2.2.1 Biological. Sapstain caused by fungi (Figure 4-3) is the blue to black, gray or brown darkening of the sapwood of both hardwoods and softwoods. The dark color is due to the deep penetration of large masses of fungal hyphae. Some sapstains may produce relatively bright colors such as red, purple, and yellow. Logs, as well as green lumber, poles, piles, and virtually all wood products, are susceptible. In warm weather the sapwood of some species can discolor in less than a week. It is generally agreed that sapstains do not seriously reduce wood strength except for toughness. Therefore, the wood should not be used where it will receive significant repeated jars, jolts or blows. However, it should be recognized that decay could easily accompany intense sapstain and thus affect other strength properties.

Like the molds, sapstains increase the permeability of wood.

Two good methods to control sapstain in lumber cut from stain free logs are kiln drying lumber immediately after sawing, or dip treating it in an approved fungicide as it leaves the sawmill.

Peeled round products such as poles and piling cannot be reliably protected by ordinary dipping or spraying. These superficial treatments will keep the surface bright, but seasoning checks will expose the interior wood.

4.2.2.2 Chemical. Stains caused by fungi should not be confused with a gray to brown chemical or oxidation stain which develops on hardwoods during prolonged warm, wet



FIGURE 4-2
Surface Mold on Sweetgum Veneer

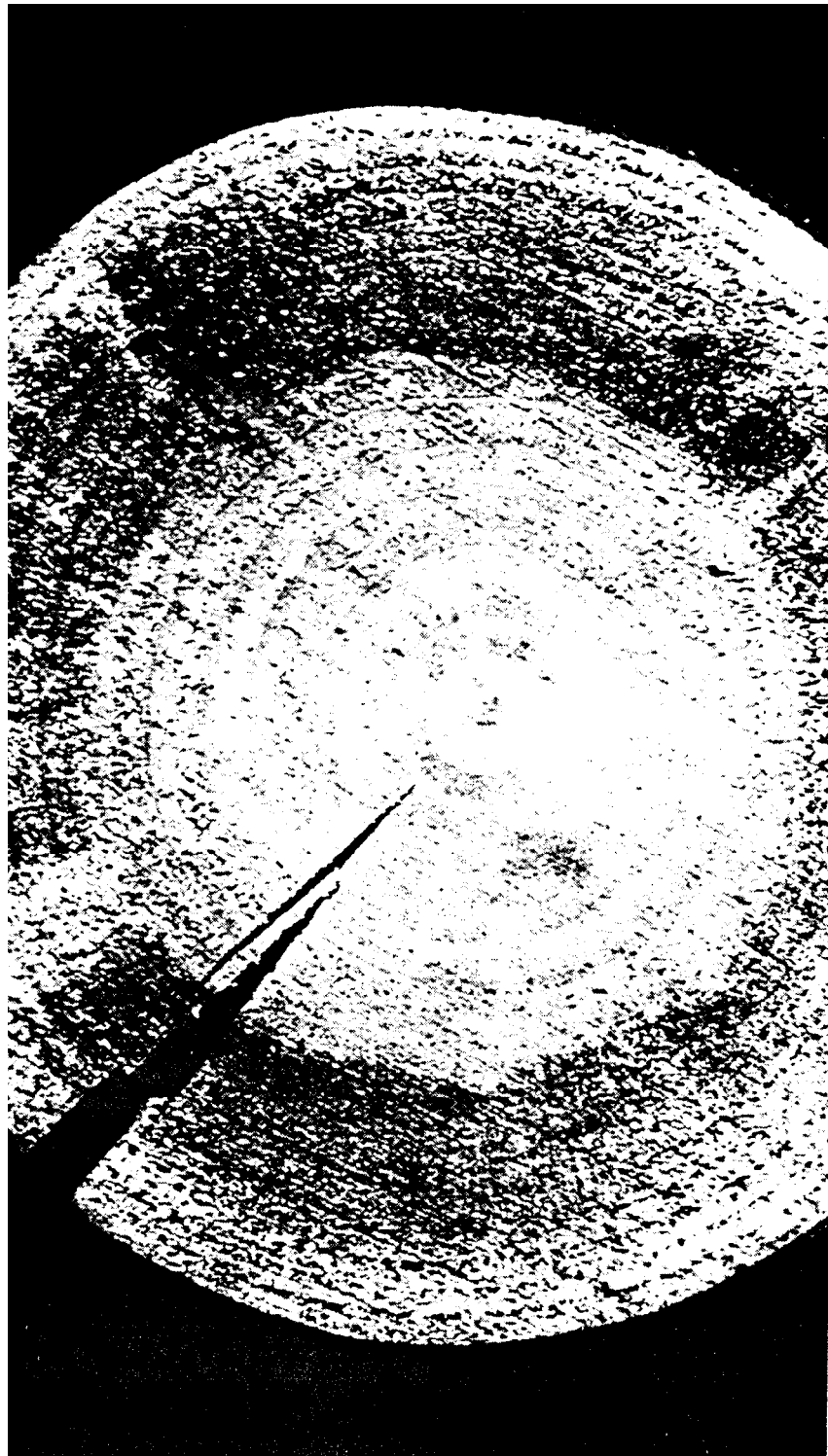

FIGURE 4-3
Sapstain in a Cross Section of Pine

seasons, especially in the southern United States. Some softwoods may also be discolored in the same manner. Chemical stain is most common in lumber but it also develops in logs. Sometimes it appears like a sapstain on the surface of lumber. However, it usually develops just beneath the wood surface where adequate drying has not occurred (Figure 4-4).

These stains are especially troublesome since they may not show up until the lumber is surfaced, and they may occur even when chemicals are used to prevent the fungus type sapstains. Chemical stain can be differentiated from the fungus type. Concentrated oxalic acid will bleach out the chemical stain, but not those caused by fungi.

4.2.3 Wood Decay. Wood decay is the fungal decomposition of woody material. In its early or incipient stage, wood decay is difficult to detect even though serious strength loss in the wood may have already occurred. Toughness is the mechanical property most sensitive to decay, and a decrease of as much as one-third to one-half of the normal toughness value may occur even before any weight loss is detected. Toughness is a measure of wood's resistance to impact bending.

Advanced decay is readily detected. Wood with appreciable decay will break brashly (abruptly) across the grain, whereas sound wood splinters at the break. Brashness, reflecting reduced toughness, can be detected by breaking small pieces by hand, or by lifting pieces of wood from the surface by means of a pointed tool--the "pick test" (Figure 4-5). The wood should be wet, otherwise it may break brashly even if sound. Brashness also is characteristic of compression wood (as discussed in Chapter 2), and test results should be interpreted appropriately.

Decay is prevented by keeping the moisture content of wood consistently below the fiber saturation point (i.e. 20-30 percent), or by preservative treatment of the wood.

4.2.3.1 In Manufactured Products.

Brown rot (Figure 4-6) is the predominant type of decay in softwoods used above ground. Brown rot fungi remove the carbohydrates or cellulose, leaving a modified lignin residue. In the early stages of decay, the wood surface lacks luster and appears dull or dead. As decay progresses, the wood acquires an abnormal brown color, often as if it had been charred. Cross grain cracking, collapse or crumbling, and abnormal shrinkage finally result.

Dry rot is an erroneous term commonly used to describe well decomposed, brown-rotted wood. It is applied to wood which is both rotten and relatively dry, thus dry rotted. Actually, the wood was wet when it decayed and subsequently dried out.

The strength properties of wood attacked by brown rot fungi decrease rapidly even in the early stages of decay.

White rot occurs when fungi preferentially remove lignin or by removing both lignin and cellulose together. White rot (Figure 4-7) is important in hardwoods used above ground. In the early stages of decay, the wood color tends to turn an off-white, sometimes making

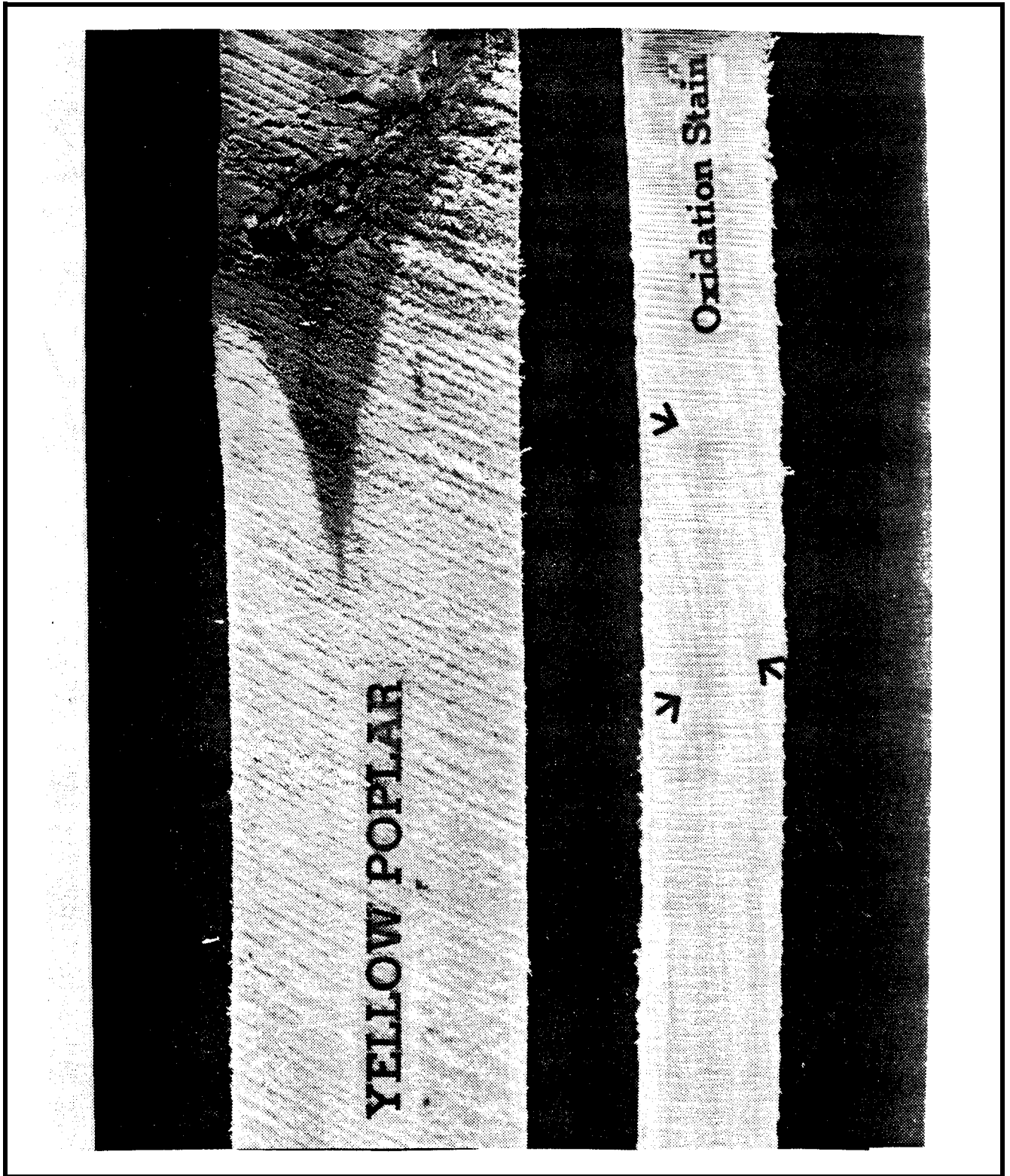

FIGURE 4-4
Interior Oxidation or Chemical Stain of Yellow Poplar



FIGURE 4-5
When Wet Wood is Probed with a Pick or Comparable Tool, it
Tends to Lift Out as a Long Sliver or it Breaks by
Splintering if Sound (left) but if Decayed even Slightly, it
Tends to Lift in Short Lengths and to Break Abruptly,
Without Splintering (right)

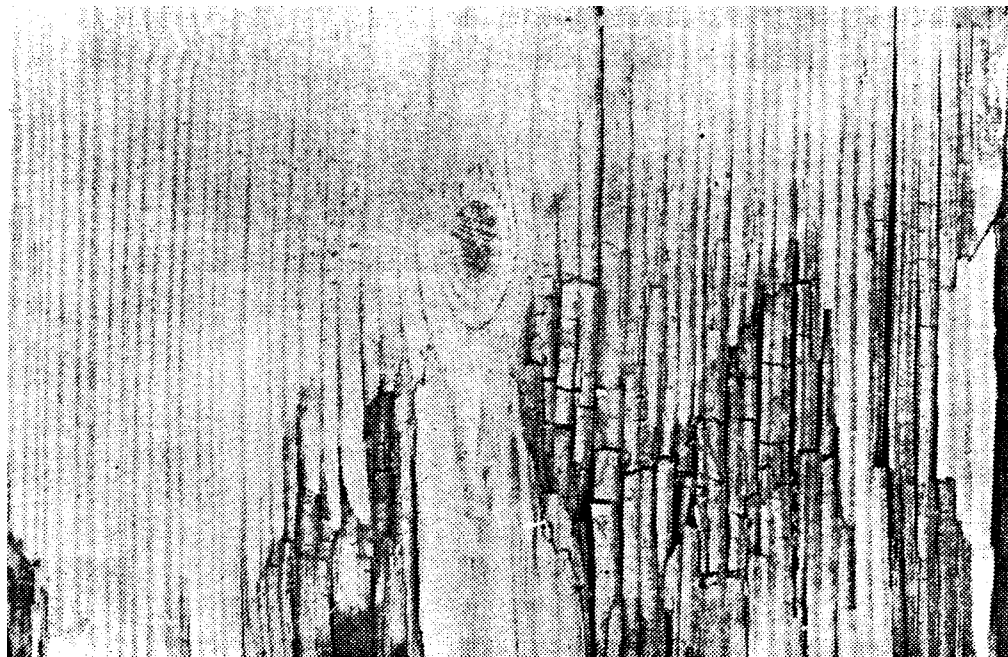
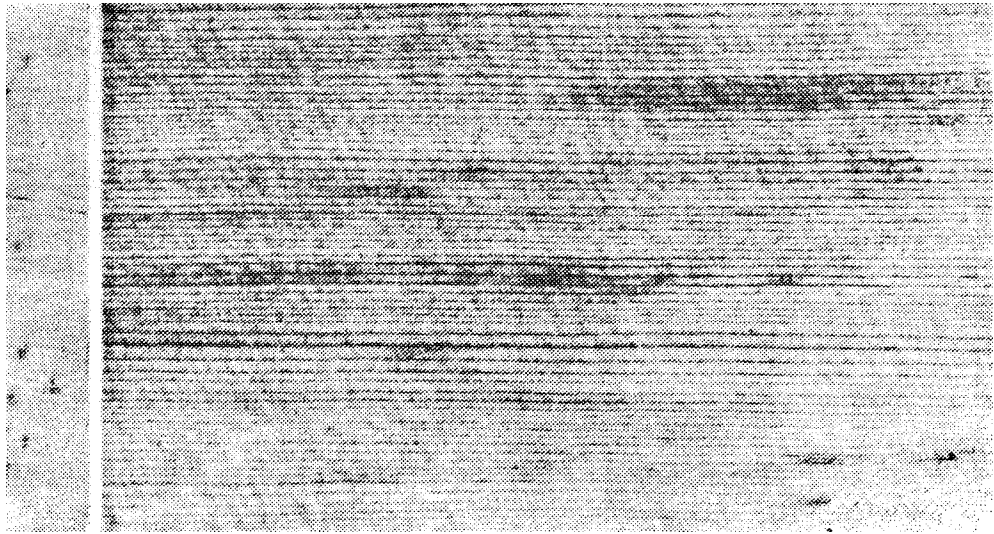

FIGURE 4-6

Early Stage of Brown Rot Showing Discoloration on Side Grain (top right) and End Grain (top left) of the Same Board and Across Grain Cracking and Collapsed Wood Associated with Advanced Brown Rot (bottom)

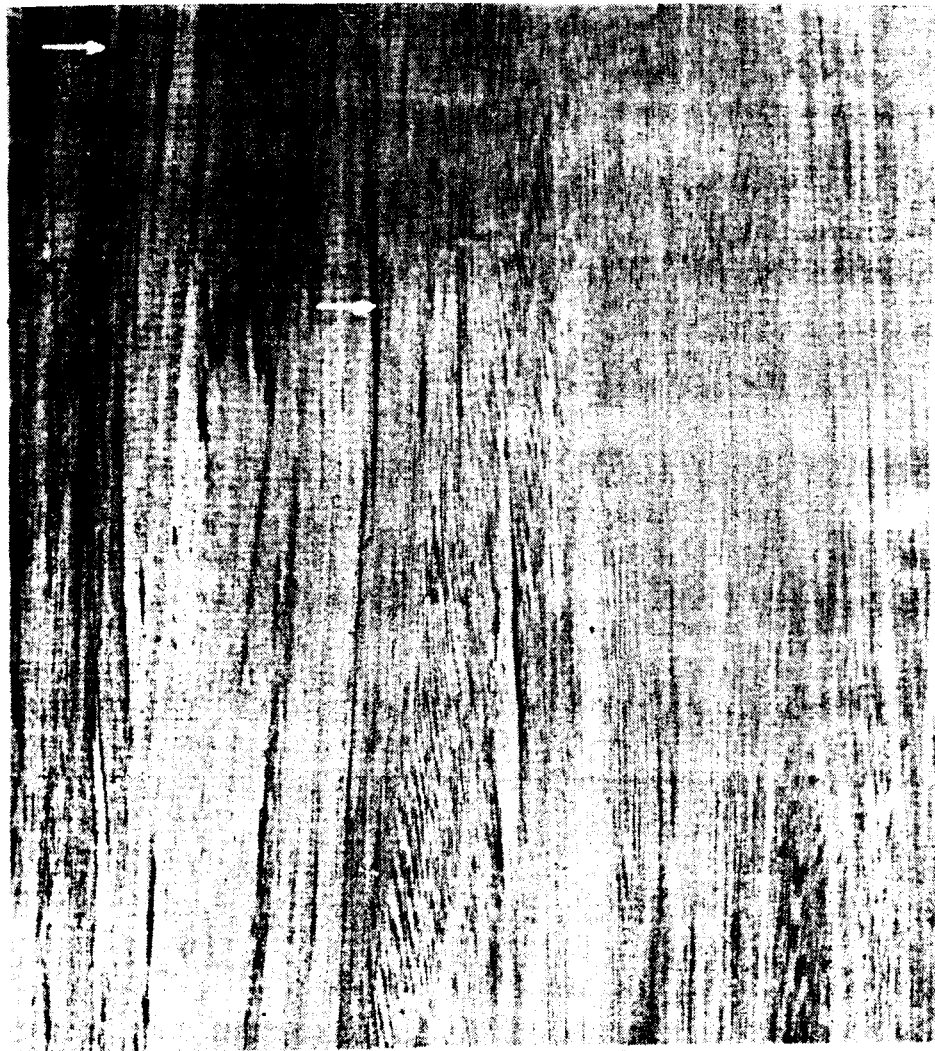
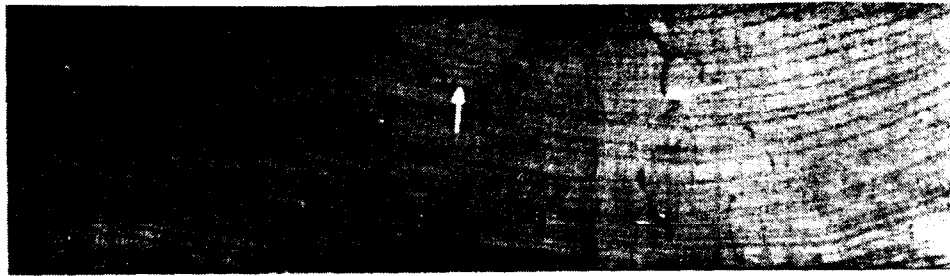

FIGURE 4-7
Discoloration from White Rot on End Grain, Characterized by
Mottling and Dark Zone Lines (arrows) Bordering the
Abnormally Light-Colored Areas (top) and Side Grain of the
Same Board (bottom)

the wood appear bleached. Black zone lines may develop in the light areas. Unless severely degraded, the wood does not crack across the grain and does not collapse or shrink abnormally as with the brown rots. A white fibrous mass may result.

The strength properties decrease gradually with the exception of toughness.

Soft rot (Figure 4-8) occurs when fungi create elongated, spindle-shaped cavities which follow the angle of the cellulose fibril within the cell wall. Wood exposed to very wet conditions seems to suffer most commonly.

The surface of wood that has soft rot can be scraped off with a fingernail. The wood is darkened, dull brown to blue-gray. When dry the surface may appear as though it had been lightly charred, and there will be profuse fine cracking and fissuring both with and across the grain. When probing with a sharp object, the degraded wood will be comparatively shallow and the transition between it and the underlying firm wood will be abrupt.

The soft rot fungi have been shown as a group to be able to better tolerate certain extremes of the environment such as higher temperatures, higher pH's, tolerance of preservative chemicals, and ability to grow with restricted oxygen. They are important in cooling towers and in hardwoods preservative treated with water-borne preservatives.

4.2.3.2 In Trees. The term, "pocket rot", describes decay in wood that is characterized by small cavities of severe decay, scattered throughout the wood. Two pocket rots which started in trees growing in the forest and which are seen in wood after the products are put into service are described below:

White pocket rot (Figure 4-9), in the advanced stage, appears as spindle shaped, pointed pockets or cavities parallel to the grain and separated by apparently sound wood. Within the pockets, the wood is reduced to a white fibrous mass of cellulose, and in other cases the pockets may be empty. This type of decay may be seen in Douglas-fir lumber cut from old growth trees. This lumber is accepted in certain grades.

Brown pocket rots (Figure 4-10) can affect softwood species such as cedar and cypress. The pockets are elongated in the direction of the grain and are several times longer than broad. In the early stages of decay, the pockets are at first firm, and in the advanced stages are filled with a dark brown, carbonaceous, crumbly mass typical of brown cubical rot. The line of separation between the sound and decayed wood is sharp.

The fungus may continue development in dead trees, but it does not develop after wood is placed in service. Therefore, control measures are not necessary.

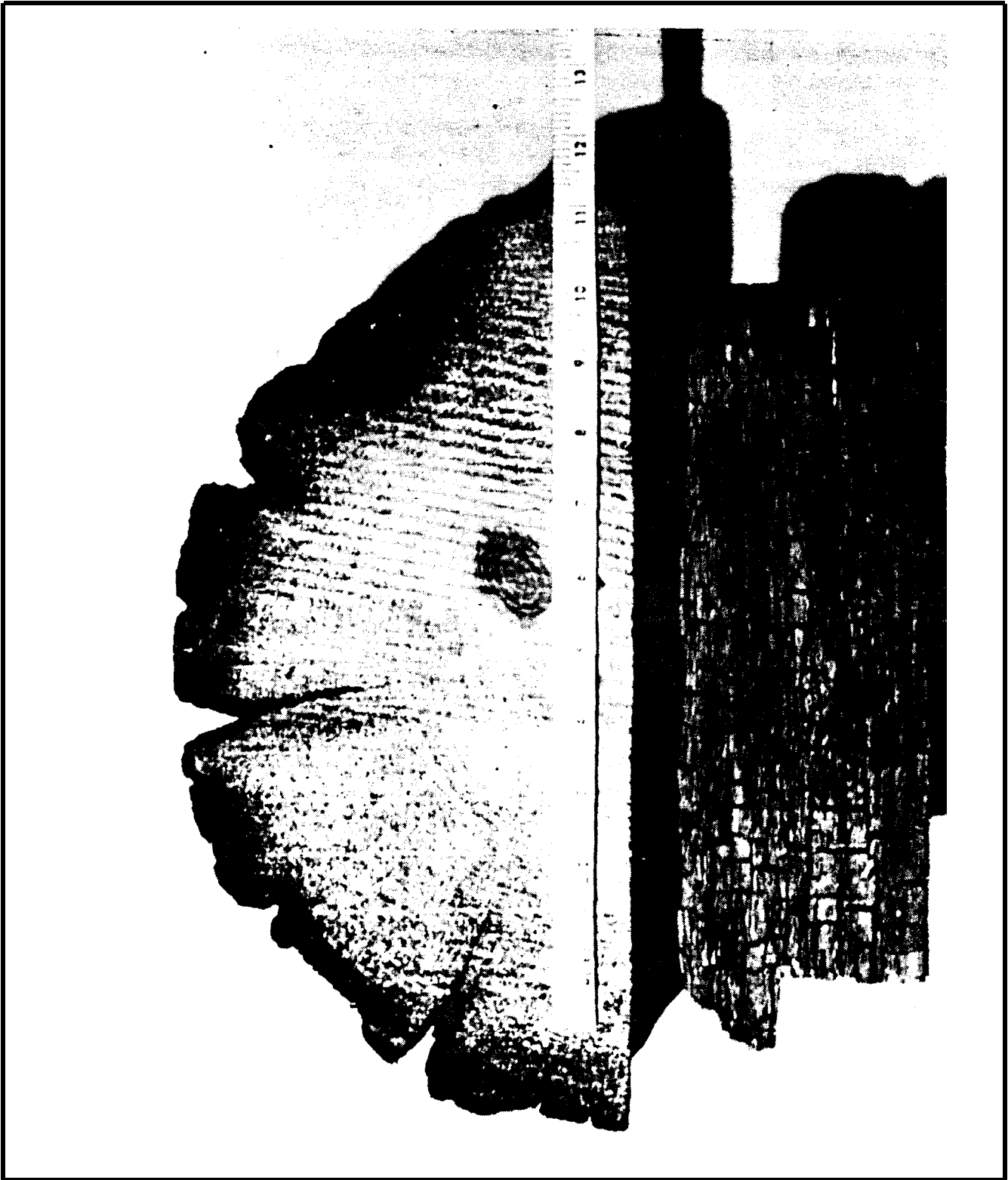

FIGURE 4-8
Typical Surface Checking of Soft-Rotted Wood when Dry

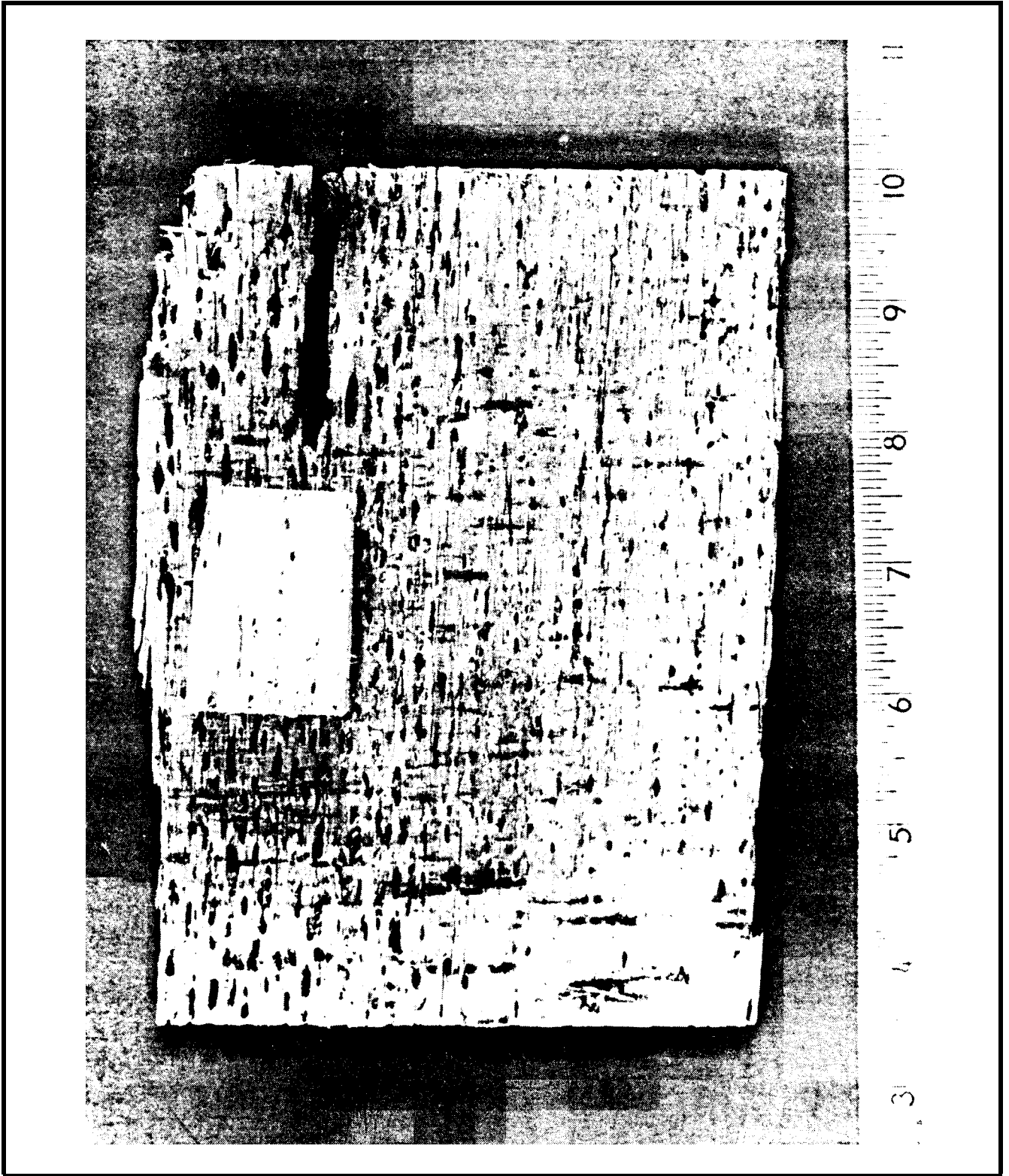

FIGURE 4-9
White Pocket Rot in Douglas-Fir

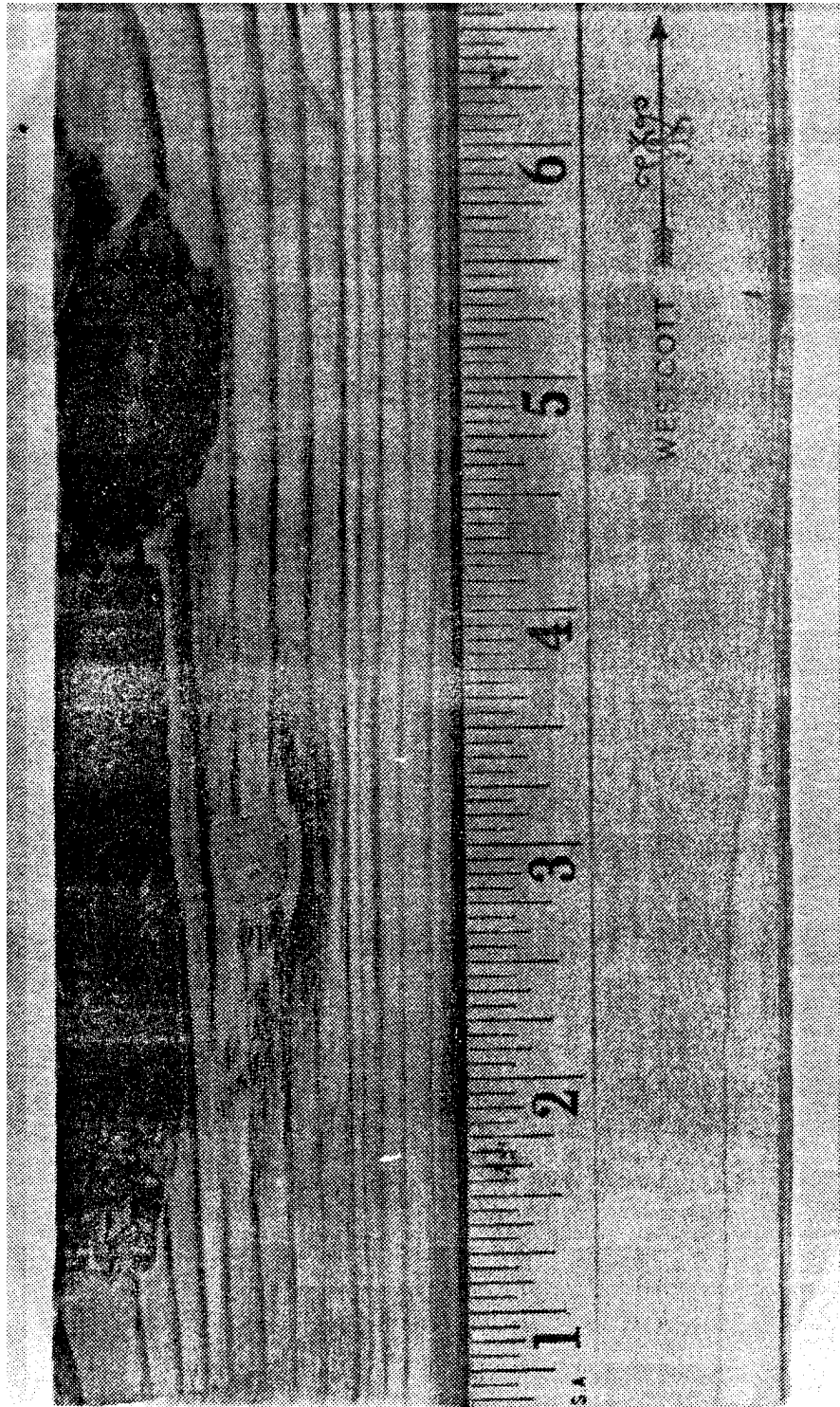

FIGURE 4-10
Brown Pocket Rot in Western Red Cedar

4.3 INSECTS. Wood destroying insects require three conditions to complete their life cycle. These are (1) a source from which the infestation can spread, (2) susceptible wood, and, (3) suitable conditions of temperature and humidity. Insects are often selective in what they will attack. Moist conditions that support fungal decay in wood often encourage insect infestations.

Emphasis in this section will be placed on the damage caused by insects because the damage is usually exposed and, thus, more easily observed than the insects themselves. Furthermore, two forms of insects, the immature and the adult form, may be involved in creating the damage. The adult form of the insect is present for only a portion of the year. Immature forms may be observed during other times. Thus, correct identification from the insect is often difficult. The important characteristics for termites and carpenter ants are summarized in Table 4-2 and for wood boring insects in Table 4-3.

4.3.1 Subterranean Termites. Subterranean termites refer to both native and imported species which have specific requirements for moisture. The insects maintain their nests in the ground or in very close contact with other sources of moisture. Subterranean termites range throughout much of the United States (Figure 4-11).

When damaged wood is broken open, several characteristic features can be observed (Figure 4-12). First, termites tend to eat the soft earlywood and leave behind the hard latewood. A thin outer shell is left around the entire wood member. Some cavities may contain substantial quantities of soil mixed with chewed wood. The gallery walls of the damaged wood and shelter tubes will have a pale, spotted appearance resembling dried oatmeal. The appearance is produced by the plastering of soft fecal material on the surface. There are no fecal pellets in subterranean termite galleries.

4.3.1.1 Native Species. Native subterranean termites are small to medium sized insects that live in social groups or colonies. These individuals will be found in different stages of metamorphosis (egg, nymph or adult) and different casts (reproductive, workers, and soldiers). Both winged and wingless adults occur in any one colony.

A termite colony is initiated with two primary reproductives or swarmers. The swarmers are light tan to black in color with four equal-sized wings, three pairs of legs, one pair of antennae and a pair of large eyes on the head, and are about 1/3 to 1/2 inch long (Figure 4-13). These primary reproductives are released by a mature colony of termites during daylight hours in the spring and early summer for most parts of the country. In the desert southwest and southern California, the swarms occur more commonly on summer nights, shortly after the first rain. Thousands of swarmers may emerge from numerous colonies at any one time, thus allowing intermixing of individuals from many populations. Termites are relatively weak fliers and their wings break off easily. The presence of large numbers of wings from these swarmers is an indication that a colony is close by. The female attracts a nearby male and the two then search for a suitable nesting site. The first eggs are laid within a week to several weeks after mating and development of the colony is very slow for several years.

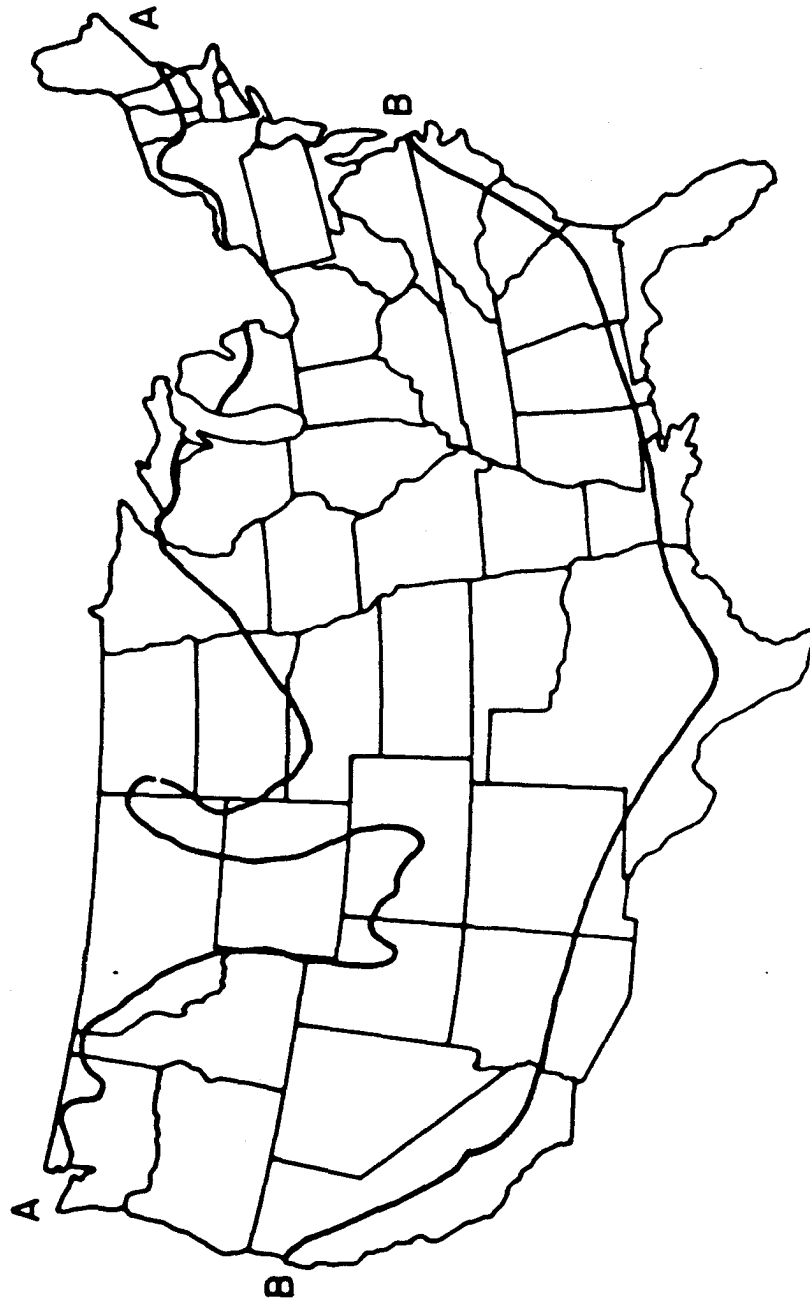

FIGURE 4-11
Range Map for Subterranean (A) and Drywood (B) Termites

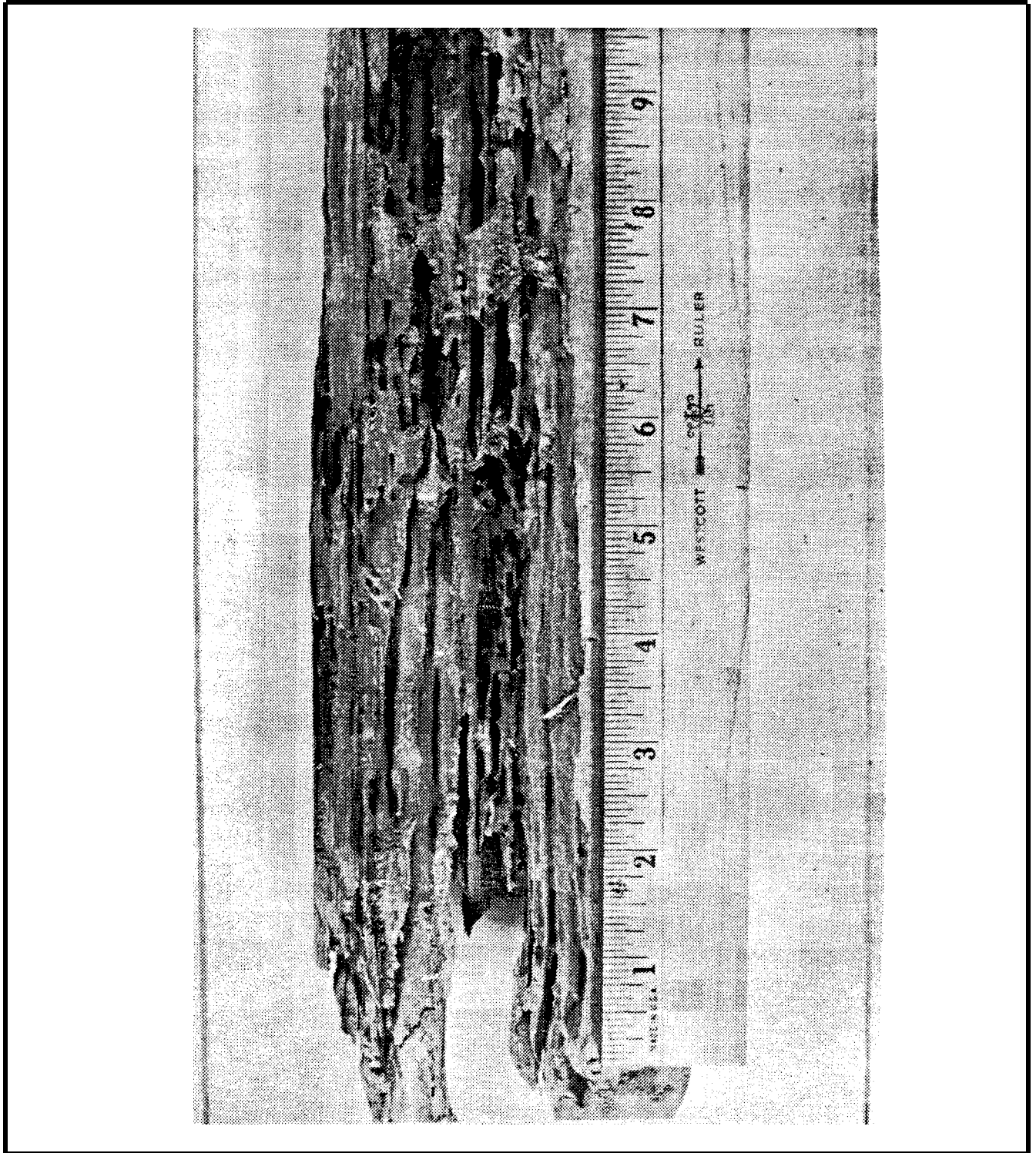

FIGURE 4-12

Termite Damaged Wood Showing the Insects' Preference for the Softer Earlywood and Accumulation of Soil and/or Fecal Material in the Galleries



FIGURE 4-13
Winged Subterranean Termite Swarmer

The usual first sign of a subterranean termite infestation is the appearance of the swarmers, or discovery of the discarded wings, usually on a window sill or other lighted area. Another common sign is the presence of shelter tubes (Figure 4-14) constructed over foundation walls or piers, in crevices between structural members or on infested wood. When active infestations or shelter tubes are damaged, termites will promptly appear (Figure 4-15). Shelter tubes are used as a means for the termites to move from their nest in the soil to wood located above ground. These shelter tubes are made from particles of soil or wood and bits of debris held together with fecal material. The tubes do not conduct moisture, but rather serve to protect the termites from enemies and allow them to return to the soil.

The only other visible sign of an infestation is the presence of dark spots or blister like areas on flooring, trim or framing members. These areas are easily crushed with a knife or screwdriver. In cases of severe damage, a wood member might be partially collapsed at bearing points or otherwise failed. Internal damage can sometimes be determined by probing the wood with a sharp instrument or by pounding with a hammer to detect hollow areas.

Several methods may be used to prevent and control subterranean termites. Pressure treatment of the wood with preservatives is one method of control. Therefore termites are usually not a problem in preservative treated poles, piles, railroad ties, heavy timbers and lumber unless they gain access through the protective preservative shell.

Treatment of the soil under and around the foundation with an approved insecticide is probably the most important step which can be taken to protect buildings. Good design and construction practices should also be followed. Untreated wood should be at least eight inches from the soil line and definitely not placed in contact with the soil. Earth-filled porches, flower planters, etc., should not be attached directly to the house. Wood debris should not be left or buried under or near the house.

Where termites are a serious problem (Figure 4-16), a yearly inspection should be carried out. Heavy damage from native subterranean termites is not likely to occur for the first five years after a house is constructed. When termites are found there is no reason for making hurried decisions. Substantial additional damage will not occur if treatment follows within six months.

4.3.1.2 Formosan. The Formosan subterranean termite has spread from the Far East to Hawaii, numerous other Pacific islands, California, Texas and to locations in the southeastern United States. It is expected to spread within its current range. This particular species is more vigorous and aggressive than the native American species and it is more tolerant to soil insecticides.

The Formosan termite differs from the native species in several features. The Formosan swarmers are larger in size (up to 5/8 inch long), yellow-brown, have hairy wings and swarm between dusk and midnight. The Formosan soldiers have an oval-shaped head with a conspicuously enlarged opening on the top from which a whitish, sticky substance is exuded. Their head is quite different when compared to the oblong and rectangular heads of the native species (Figure 4-17). The nests

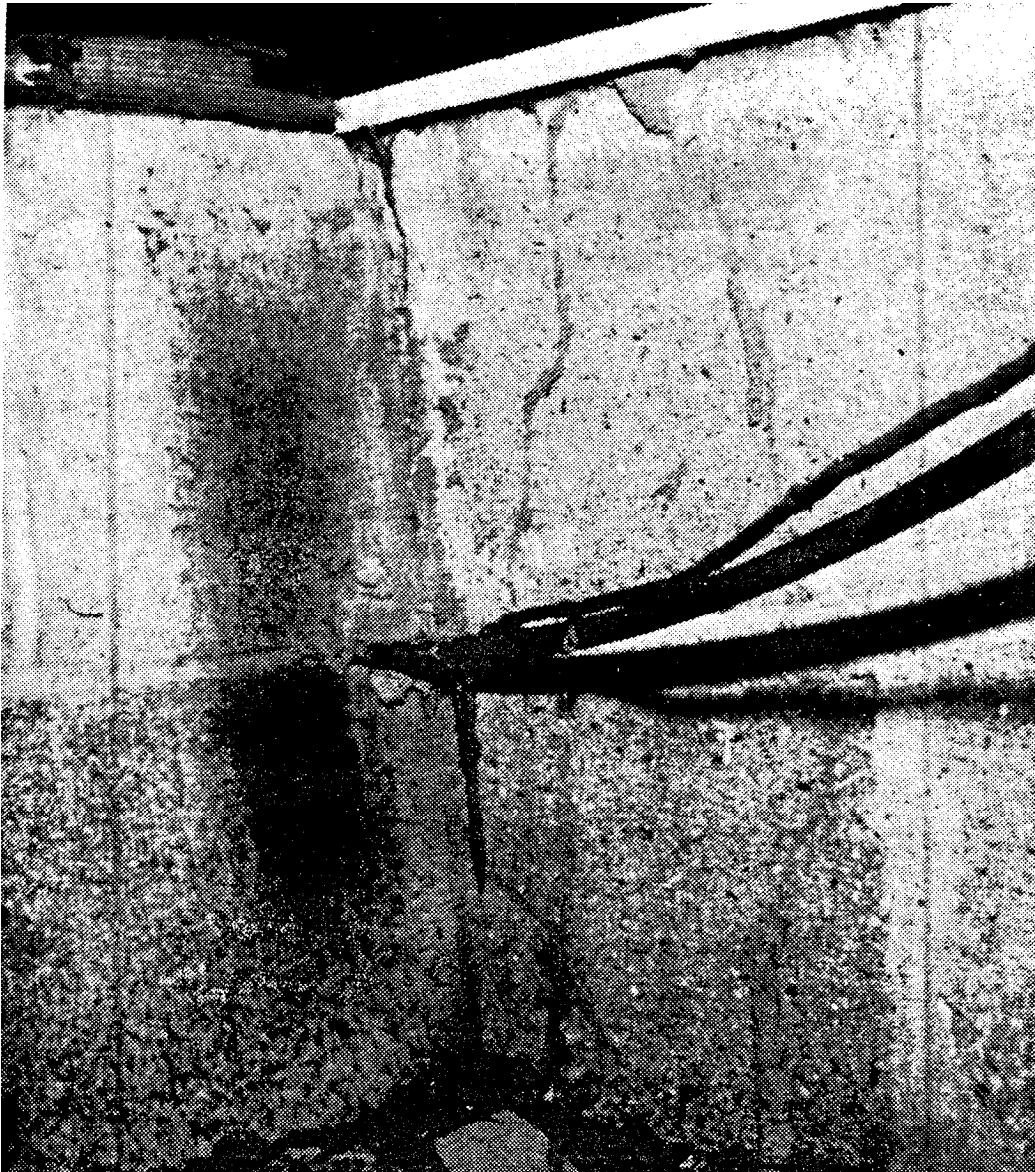

FIGURE 4-14
Subterranean Termite Shelter Tubes on the Interior
Foundation Wall of a Crawl Space Type House



FIGURE 4-15
Subterranean Termite Workers

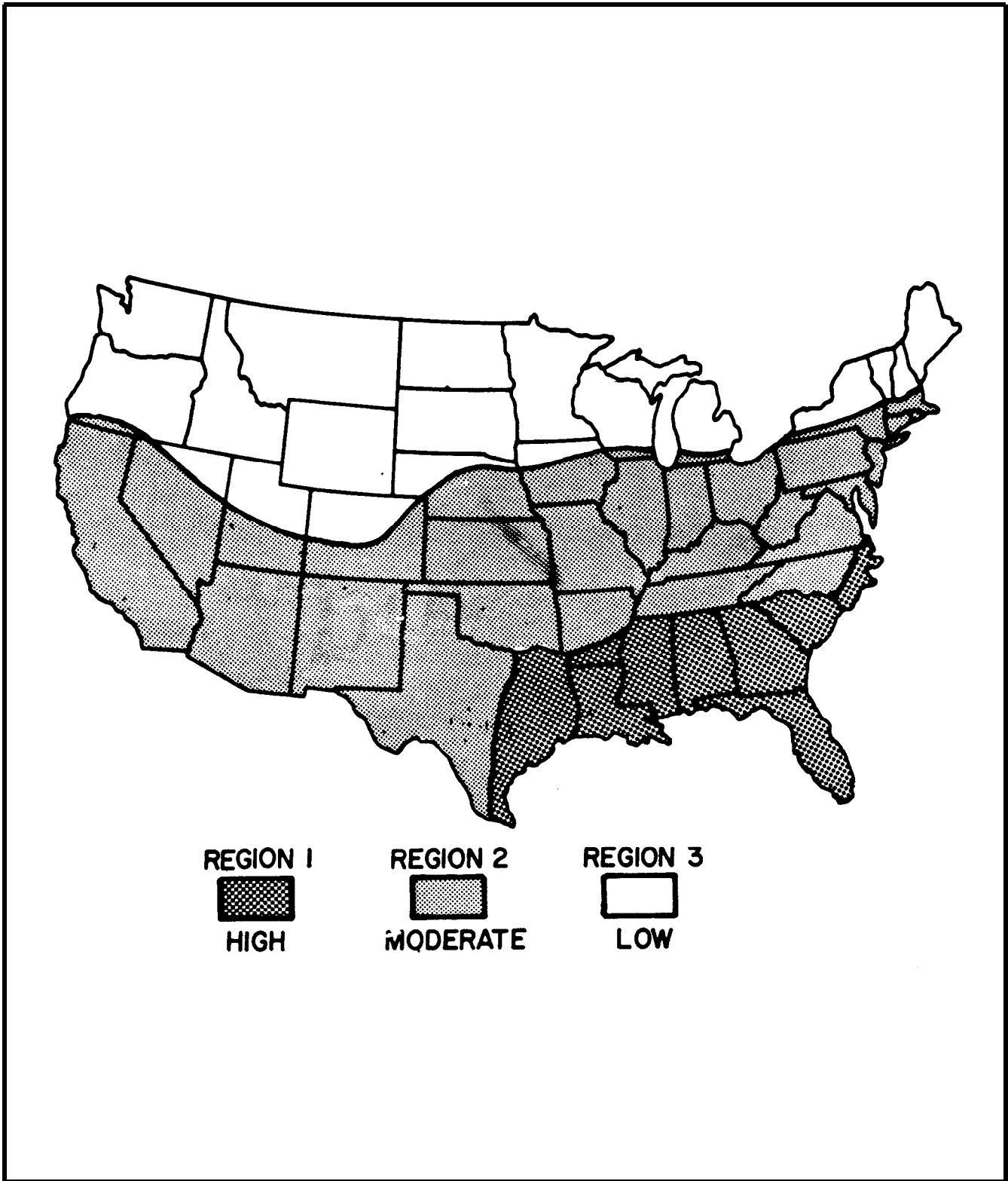

FIGURE 4-16
Hazard Regions for Subterranean Termites

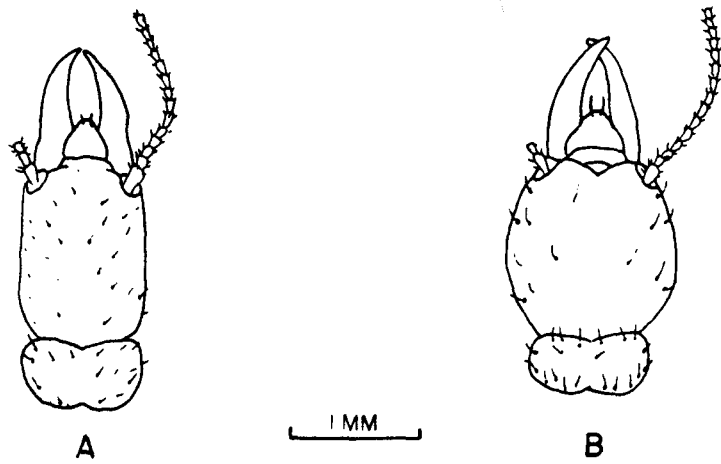

FIGURE 4-17
Head of Native Subterranean Soldier (A) and
a Formosan Subterranean Soldier (B)

are made of a rather hard material called carton, which resembles a dried sponge. Unlike the native species, carton can be placed in the wall cavity of a building adjacent to the damaged wood. Carton is composed of chewed wood, soil, saliva and fecal material.

Formosan termites multiply quickly and can cause serious damage in less time than the native species. If found, treatment within a few months is suggested. The control measures given for the native subterranean species also apply to the Formosan termites.

4.3.2 Drywood Termites. Drywood termites occur in warm, humid climates. They utilize the moisture within the wood they eat. They do not need a source of water to live in wood, hence, the name, “drywood termite”. Several species range throughout the very southern United States from the east to west coast (Figure 4-11). In southern California and Arizona, southern Florida, the Pacific area and the Caribbean, new houses may be infected within five years of their construction. These insects may colonize and damage smaller wooden articles such as furniture and packing materials, therefore, they can be important pests in wood items returning from the tropics.

Drywood termites tend to work just under the surface of the wood, leaving a very thin veneer-like layer. Wood damaged by drywood termites has broad pockets or chambers connected by tunnels which cut across the grain without regard for earlywood or latewood (Figure 4-18). The galleries are perfectly smooth and have no surface deposits. Some fecal pellets may be stored in portions of the galleries; the galleries are closed off by partitions made of fecal pellets stuck together with a secretion.

Piles of fecal pellets are usually the first signs of a drywood termite infestation. The pellets are hard, elongate, less than 1/25 inch in length, with rounded ends, six flattened or concavely depressed sides and light gray to very dark brown in color. The shape results from the water extraction process which occurs in the rectum of the termite. The pellets are eliminated from the galleries in the wood through round kick holes. The holes are closed with a secretion and pellets when not being used. Probing wood with a sharp instrument or pounding the surface may reveal hidden damage.

Drywood termites are slightly larger than the subterranean termites, but are similar in appearance. Swarmers vary in size from 1/2 to 5/8 inch in total length, and are lighter in color than the subterranean species. Drywood termites swarm at different times of the year depending on the geographic location. The wing veins are the most distinctive feature of the swarmers. There are several distinct longitudinal veins with many cross-veins in the front edge of the wing. This differs from the subterranean termite wing, which basically has only two prominent longitudinal veins at the front edge.

Drywood termite soldiers are similar to the subterranean ones. However, the soldier of the West Indian drywood species has a distinctive black head almost as long as high, and it is concave and rough in front. The mandibles are not enlarged. The soldiers function only to block openings in galleries with their heads.

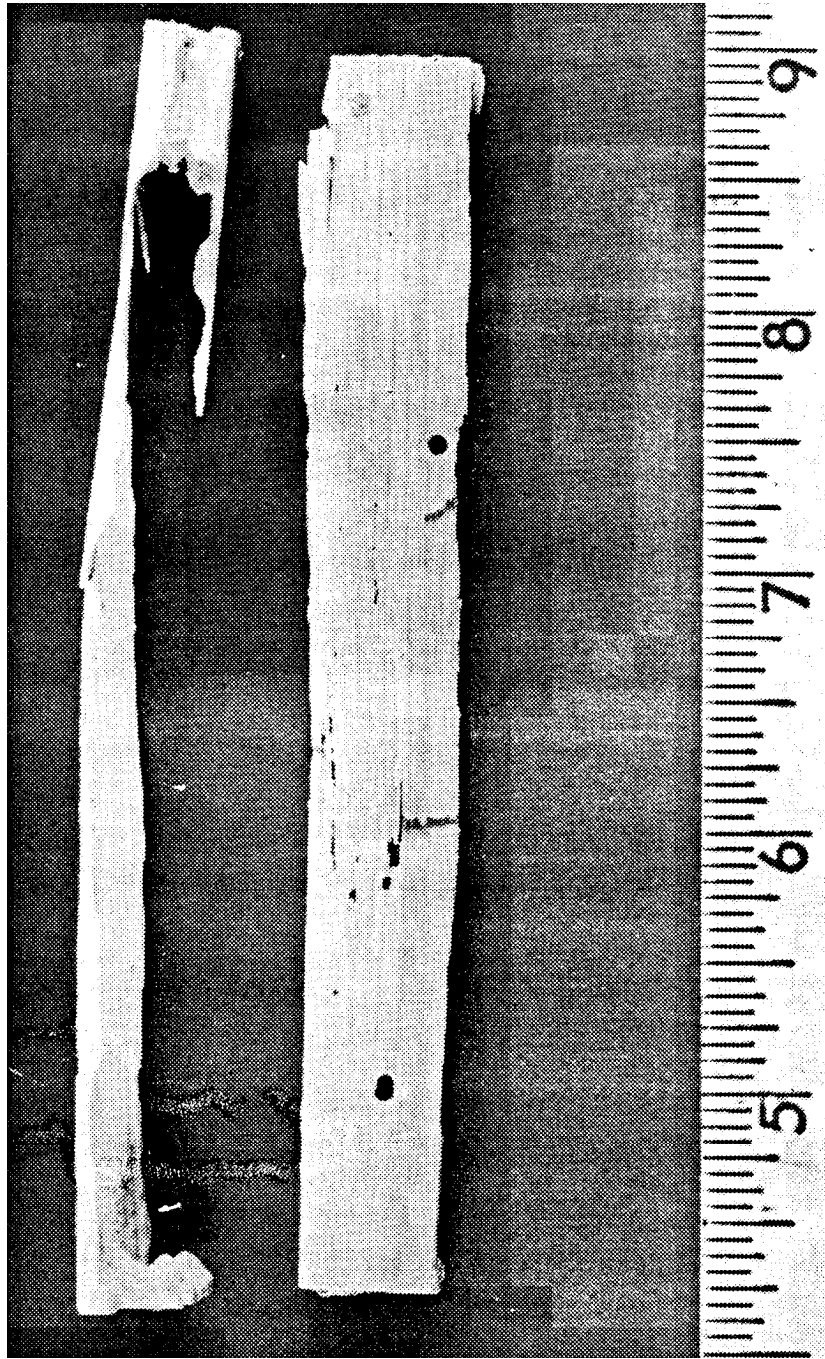

FIGURE 4-18

Drywood Termite Damage Showing Round “Kick Holes” and the Very Thin Veneer-Like Layer Left after Excavating without Regard for Earlywood or Latewood

The methods available to prevent drywood termite attack are not as practical nor as economical as those to prevent subterranean termites. However, where drywood termites are considered to be a serious problem (Pacific area, southern coastal California, southern Florida, and the Caribbean area) control measures should be taken.

First, any article of furniture, lumber, crating, or other cellulosic material should be carefully examined before it is used or placed in a new or existing structure. Potential outdoor sources of infestation such as stored lumber, firewood, dead branches, etc. should be examined or removed. The use of fine screening over attic and crawl space vents has been recommended, but this measure is not effective since the screen mesh must be so small to prevent insect passage that it would become clogged and restrict air movement. Desiccating dust application is effective in prevention. Fumigation is also effective for items in transit, but for houses, it is expensive and needs to be repeated in areas of severe regional infestation.

4.3.3 Dampwood Termites. These termites locate their colonies in damp and sometimes decaying wood. Soil contact is not required if the wood is damp. Although they are found in the southern tip of Florida, the Caribbean, Nevada, Idaho and Montana, their economic importance is restricted to the Pacific Coast.

The damage done to the wood depends on the amount of decay present. In comparatively sound wood, the dampwood termite tunnels or galleries will follow the soft earlywood, just like subterranean termites. If the wood is well decayed, the galleries or tunnels will be much larger in diameter and will pass through both earlywood and latewood. The galleries may be round or oval in cross section, some quite broad. The surface of the galleries has a velvety appearance, and they can be covered with dried fecal material.

Since these termites require the presence of damp wood, the same measures used to keep wood dry and prevent decay will control them.

4.3.4 Carpenter Ants. Carpenter ants are typical of all ants. They have a very narrow waist (unlike termites) and wings of two different sizes, the front ones much larger than the hind ones (unlike termites with equal-sized wings). Ants and termites are compared in Figure 4-19. The adults of those species found nesting in houses are predominantly black; however, some may be partially reddish-brown to yellowish.

Carpenter ants burrow into the wood to make nests and do not use it for food. Most species prefer to nest in moist hardwoods and softwoods that have begun to decay. The galleries extend both along the grain of the wood and around the annual rings. The softer earlywood tends to be removed first. The harder-grained latewood is penetrated at frequent intervals, so that, unlike galleries made by subterranean termites, there is complete access (across annual rings) between the galleries (Figure 4-20). Once a nest is established, it can be extended into the sound wood. The surfaces of ant galleries are smooth and perfectly clean. This contrasts with galleries of subterranean termites in which walls are rough due to the coating of fecal materials. The general appearance of ant galleries

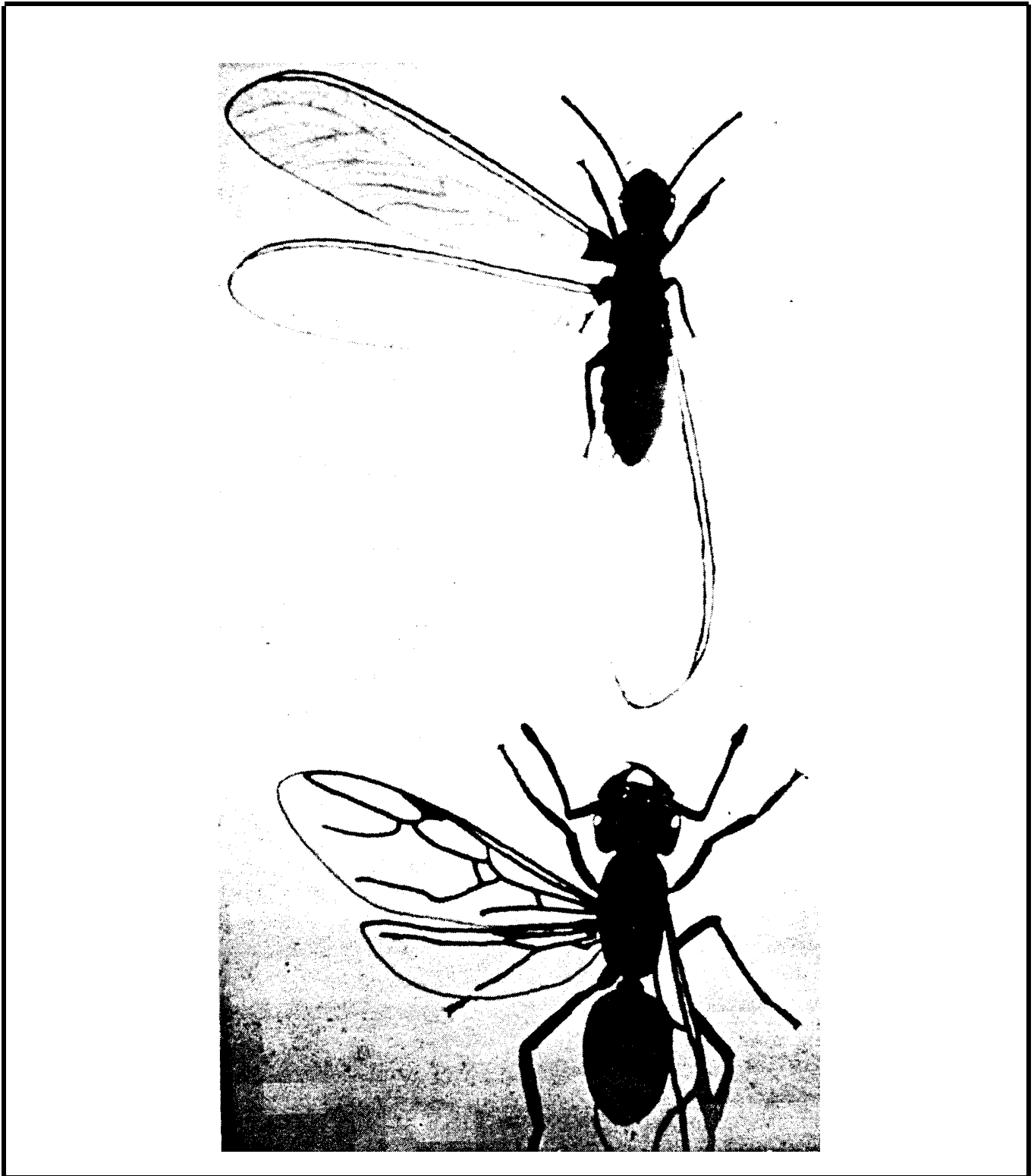

FIGURE 4-19

Major Differences between Ants and Termites include Waist and Wing Size

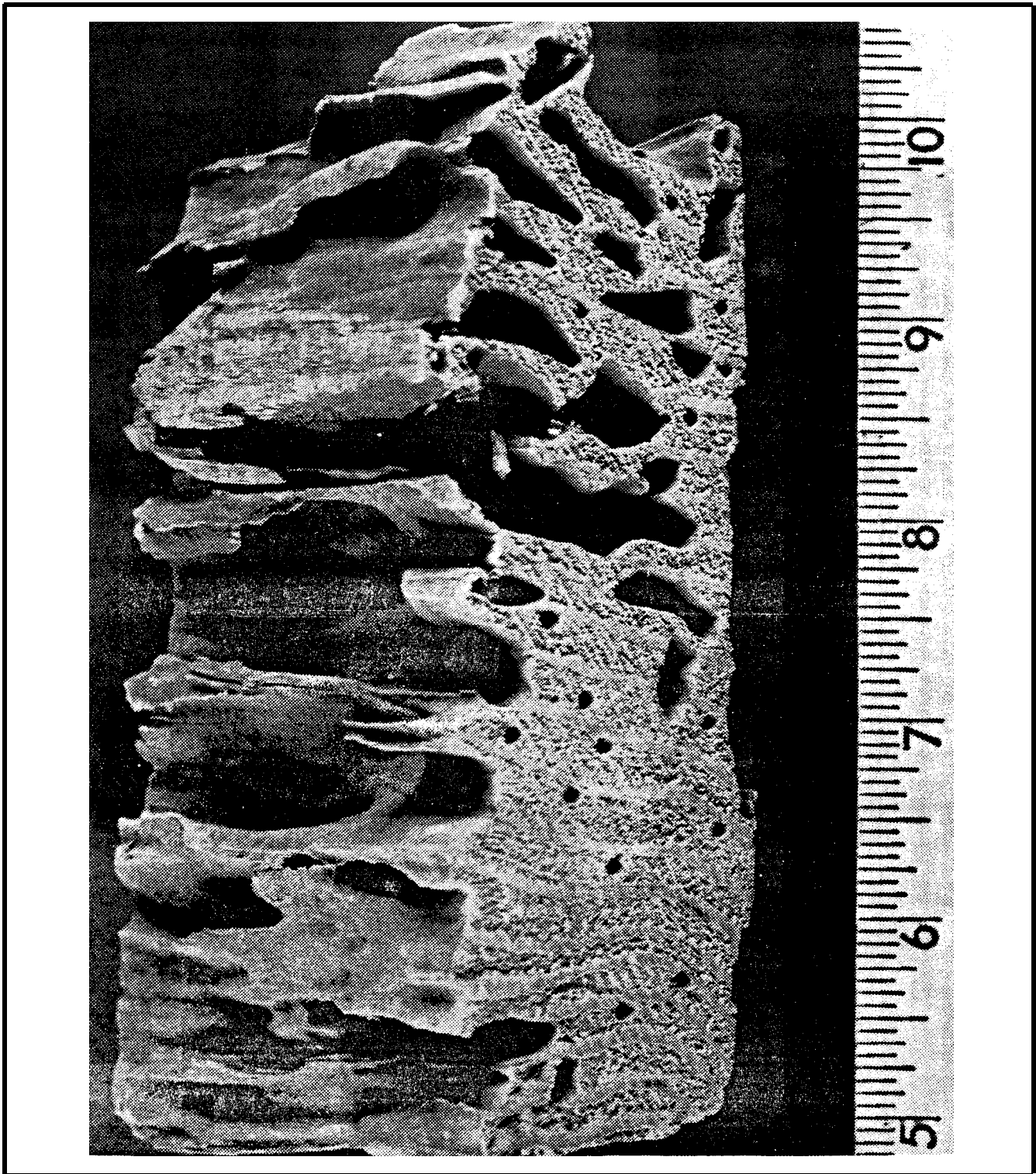

FIGURE 4-20

Carpenter Ant Damage to Douglas-Fir Showing Preference for Earlywood and Removal of Some Latewood to Allow Access Between Galleries

is similar to those made by drywood termites, but there are no fecal pellets, and the frass is completely removed except for occasional deposits in unused galleries.

Carpenter ants also can nest in houses without attacking timbers. They simply use existing cavities, including wall voids, hollow flush panel doors, termite galleries in wood, etc. Carpenter ants are generally more of a nuisance when found crawling around the house foraging for food and water.

Ants are like termites because they live in colonies composed of several casts. There are winged and unwinged queens, winged males, and several sizes of unwinged workers.

In addition to the presence of large black ants, other indications of an infestation are piles or scattered bits of very fibrous and sawdust-like frass which the ants have removed from the wood. If the pieces are from decayed wood, they tend to be darker and more square end. The frass will contain fragments of ants and other insects mixed with the wood fibers. The frass is expelled from cracks and crevices, or from slitlike openings called windows made by the ants. These “windows” are the only external evidence of attack by carpenter ants. The frass is quite often found in basements, dark closets, attics, under porches, and other out-of-the-way places. Faint rustling and even gnawing sounds can be heard in the wood or cavity when the ants are active.

Good building practices that keep wood dry will contribute to a reduced risk of attack by carpenter ants. These practices include: adequate clearance between wood and soil, good drainage and ventilation, proper roof flashing, tight exterior wood joints, etc. If the wood cannot be kept dry, such as that on some porches, decks, columns, etc., it should be pressure treated with an appropriate preservative. Chemical treatment of soil under and around a foundation to prevent subterranean termites may not prevent attack by carpenter ants.

If carpenter ants are present, the nests should be treated with residual contact insecticide applied as a dust or spray. The infested wood can be bored, the pesticide injected and the holes plugged. The approaches and areas surrounding the nest should also be treated. Treating the areas where the ants are seen is seldom effective, since many ants never leave the nest. For treating indoors, pesticides specifically registered for that purpose must be selected. Poison baits may be available.

4.3.5 Powder Post and Other Wood Boring Beetles. The term “powder post” describes a group of beetles that convert the inner portion of infested wood to a powdery or pelleted mass. The thin outer shell on the surface of infested wood often shows numerous small holes through which the beetles exited. These exit holes aid in the recognition and identification of beetle attack (Table 4-3). Damage is probably heaviest in warm, humid climates but can occur throughout the world. Table 4-3 summarizes the major characteristics of these important wood boring beetles as well as other less serious pests which may be mistaken for them. A detailed discussion for each group is provided below.

4.3.5.1 Classifications.

Anobiids, sometimes referred to as death watch beetles or furniture beetles, are found on recently seasoned and older hardwoods or softwoods throughout the United States. Sapwood, particularly that close to the bark, is preferred because it contains the highest percent of starches, sugars and protein. Unheated buildings or houses built with crawl spaces over damp ground, as often occurs in the southeastern United States, are particularly susceptible, but houses are usually ten or more years old before damage becomes obvious.

It is very difficult to detect an anobiid infestation. During and after emergence, a bright and light-colored powdery frass and tiny pellets will be found streaming from the exit holes or accumulating underneath infested wood. The frass in the galleries is loosely packed and does not tend to fall freely from the wood unless the wood has dried out considerably since the attack occurred. The exit holes are round and vary in diameter from 1/16 to 1/8 inch (Figure 4-21). The anobiid pellets are smaller than those excreted by drywood termites and taper towards each end. Some pellets are bun shaped. When anobiid infestations die out naturally, the frass is yellowed and partially caked on the surface.

In most old, heavy infestations there are very tiny round exit holes, about 1/32 inch (0.6 mm) in diameter, scattered over the infested surface. These are emergence holes of parasitic wasps, the larvae of which feed on the beetle larvae.

Lycids beetles attack the sapwood of hardwoods. They probably cause more damage to U.S. hardwoods than any other group of beetles and are also an important pest of imported hardwood products. Ring porous hardwoods such as oak, hickory, and ash are the most susceptible, but semi-ring and diffuse porous woods such as walnut, pecan, poplar, sweetgum and wild cherry are also susceptible. The greatest activity of the beetles occur where the wood moisture content is between 10 and 20 percent, but beetle activity can occur where the moisture content ranges from 8 to 32 percent.

The female deposits eggs in the pores of the wood (pores must be at least 1/325 or .003 inches in diameter) or possibly in cracks and crevices. When the larvae hatch, they first bore along the vessel, thus enlarging the tunnel as they grow. The tunnels are straight and initially along the grain, but later become more irregular and often intersect other tunnels. Mature grublike larvae are usually less than 1/4 inch, curved, wrinkled, enlarged at the thorax and have six legs. The larvae form a pupal chamber just under the wood surface. The adult beetle then cuts its way to the surface forming a circular exit hole. The entire life cycle usually requires 9 to 12 months, but may be shorter if conditions are favorable. One species can complete a life cycle in 4 months. The beetles will reinfest the same wood source.

Infested wood does not show any external evidence of attack until the first generation of adult



FIGURE 4-21
Anobiid Damage Showing Insect Exit Holes

beetles emerge. The circular emergence holes and longitudinal galleries are 1/32 to 1/16 inch in diameter (Figure 4-22). Small piles of fine flour-like wood or frass can be found on or under the wood. The frass is loosely packed and a slight jarring of the wood will make the frass sift from the holes. With severe infestations, the sapwood may be completely converted to frass held in by a very thin veneer of surface wood with beetle exit holes. With heavy infestations, parasitic wasps, which make circular holes larger than those of the beetle, may be seen.

Bostrichids are also called false powder post beetles, or large powder post beetles to distinguish them from the lyctids. Because they naturally infest dead or dying branches, they are also called branch and twig borers. These beetles are of less importance in wood products than are anobiids or lyctids. These insects normally do not reinfest wood, but one generation can do substantial damage in some cases.

Most species prefer the sapwood of hardwoods but a few attack conifers. The wood may be freshly cut, partially seasoned or relatively dry, and have the bark on. The beetles digest primarily the starch, thus their activity is predominately in the outer sapwood.

The species which attack freshly sawn softwoods usually reach maturity in one year, but may require five years if the wood dries rapidly. They are found primarily when bark edges have been left on the lumber.

The first signs of infestation are the 3/32 to 9/32 inch entry holes. The exit holes, which are similar to the entry holes, are often filled with frass. The frass is meal-like and tightly packed in the galleries and contains no pellets like those of the anobiid. Consequently, the frass does not sift out of the wood easily.

The interior of the sapwood may be filled with very round tunnels ranging in size from 1/16 to 3/8 inch in diameter, depending on species (Figure 4-23). In extreme cases, the sapwood may be completely destroyed. Damage can occur much more rapidly than with the anobiids. However, only the outer part of the sapwood is destroyed, and damage will not extend more than one or two inches into a board.

Cerambycids are one of the largest and most important family of wood boring beetles. They are found throughout the United States. Two groups of insects within this family will be discussed. These are the long-homed beetles, or round-headed wood borers, and the old-house borers.

The *long-horned beetles* derive their name from the mature beetle having antennae longer than half their body length. The larvae are described as roundheaded wood borers, presumably due to the circular emergence holes (Figure 4-24). This group should be recognized because they may emerge after the wood is put into service or their damage may be mistaken as evidence of an active infestation of the powder post beetles.

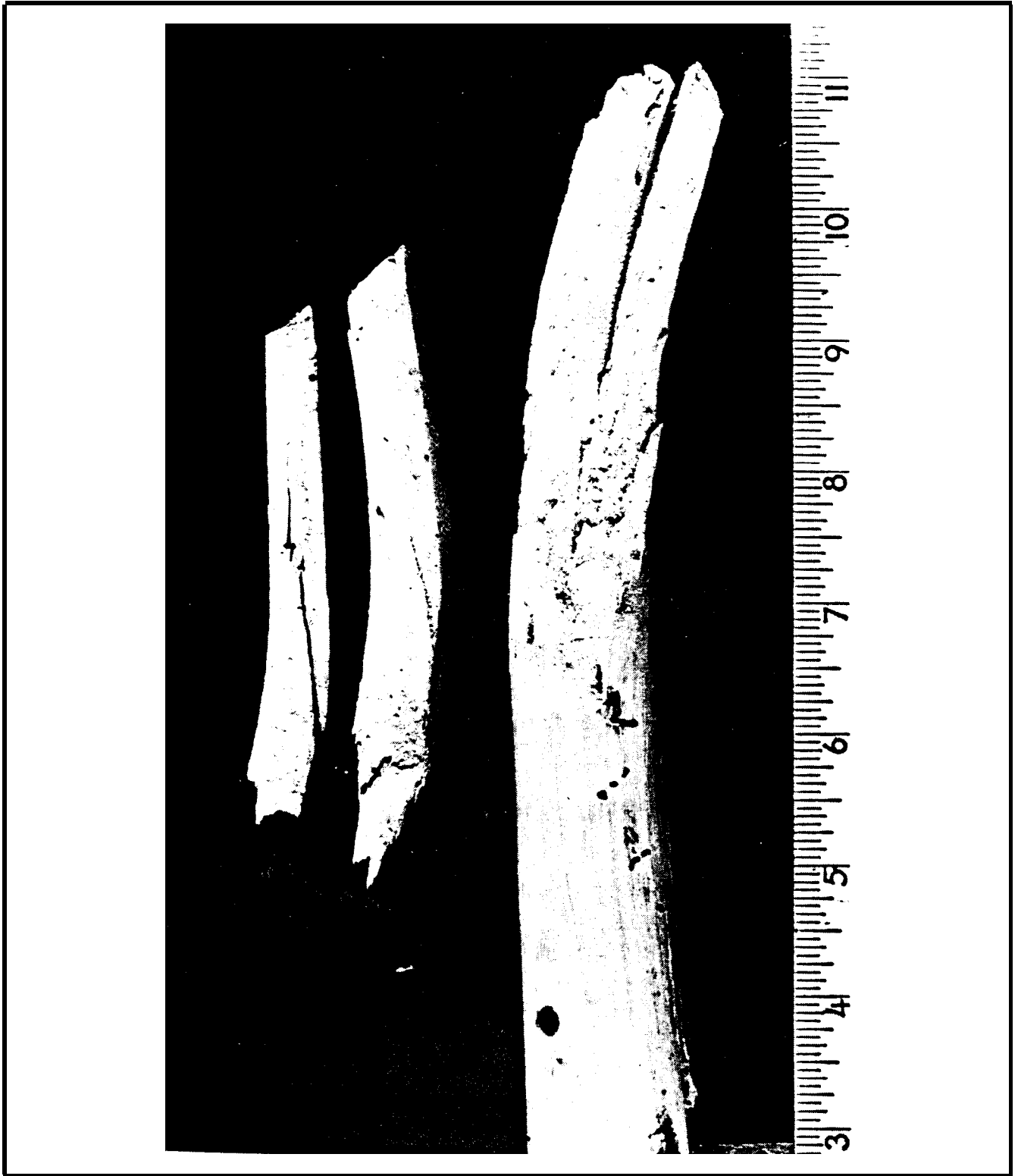

FIGURE 4-22
Ash Shovel Handle Damaged by Lyctid Beetles



FIGURE 4-23
Bostrichid Damage in Hardwood

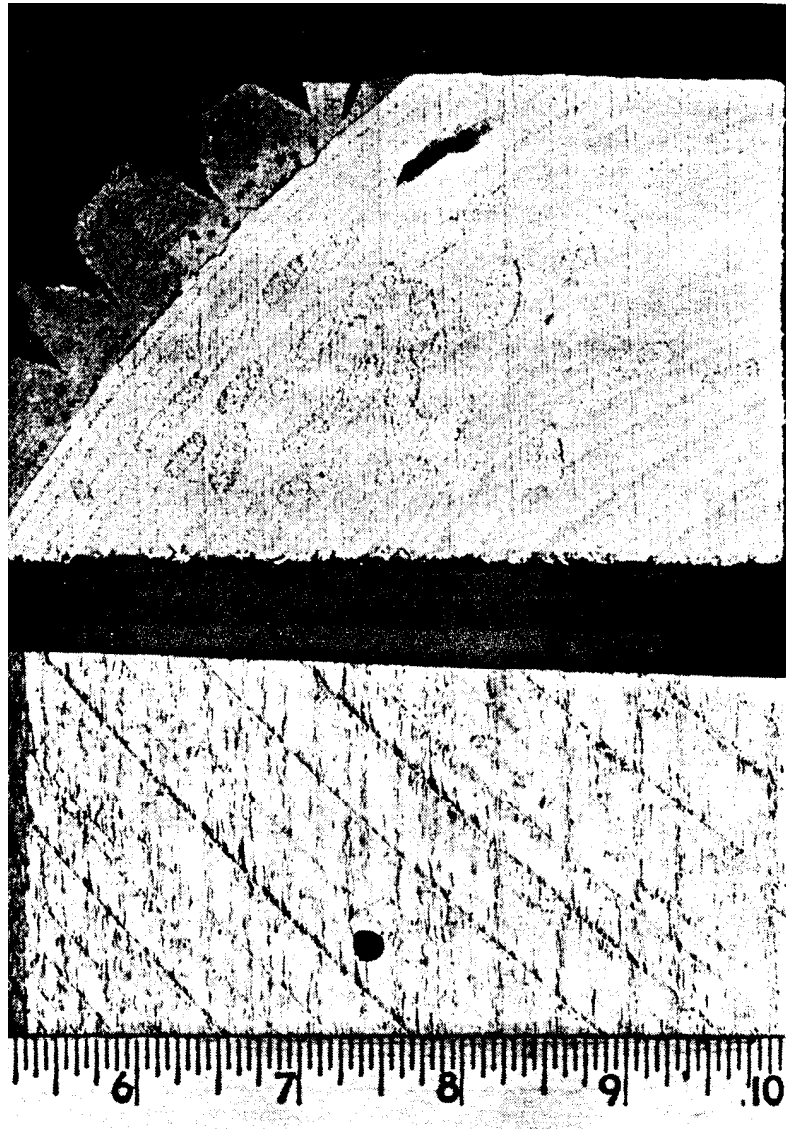

FIGURE 4-24

Cerambycid (Long-Homed Beetle or Round-Headed Wood Borer)
Damage to Ash Showing the Tightly Packed,
Rather Coarse Frass in the Galleries (top) and
the Circular Exit Hole (bottom)

Damage from long-homed beetles usually occurs in fire, disease or insect killed timber which is being salvaged. The borers damage the wood before it is processed, and activity ceases when the wood is dried. Many species feed just under the bark before moving into the sapwood, and sometimes the heartwood. Some species may survive for a year or more. Most of the beetles emerge before the wood is over 1 1/2 years old. During emergence, the borers may cut through plaster-board, hardboard, hardwood flooring, insulation, roofing felt, shingles, plywood, etc. Since the beetles are in the wood only a limited time, serious structural damage usually does not result.

As beetles emerge, they make slightly oval to nearly round exit holes ranging from 1/8 to 3/8 inches or more in diameter. The species, which are more flattened in cross-section, make oval holes about twice as wide as high, the widest diameter being about 1/4 inch. In some cases, there is coarse, even stringy, frass in evidence inside or around the exit holes.

If the damage occurred in the log, the galleries in the sawed lumber may appear oval to elongate depending on how the saw intersected the galleries. The diameter in true cross-section will vary with the age of the larva that made the gallery, and with the species involved. Tightly packed, rather coarse frass may be present in the exposed galleries (Figure 4-24). At other times the galleries are free of frass because it was loosely packed and has fallen from the wood. If the bark edges have been left on lumber, there often is much frass in evidence underneath. The texture of the frass varies from rather fine and meal-like in some species to very coarse and almost excelsior-like in other species.

The *old-house borer* is a round headed borer which, unlike most of the others in this family, is capable of reinfesting wood in use. It probably ranks next to the termites as a pest of buildings in the eastern United States. The heaviest infestations occur along the Atlantic seaboard, particularly the mid Atlantic states. It is found in old and new construction, seasoned and relatively unseasoned softwood lumber, but not hardwoods.

The adult beetle is 5/8 to 1 inch long, slightly flattened, brownish in color with many gray hairs on its head and the forepart of the body. The hairs are easily rubbed off. The pronotum has a shiny ridge down the middle and a shiny raised knob on each side. This gives it the appearance of a face with a pair of eyes. The adult lays its eggs in cracks and crevices in the wood. The larvae hatch in about two weeks. They are typical round-headed borers up to 1 1/4 inches long. There are three black eyespots in a row on each side of the small head. The larvae crawl over the surface of the wood and eventually bore their way into the sapwood. The larvae generally take two to five years to develop and, in particularly dry wood, they may take 12 to 15 years. A moisture content range of 15 to 25 percent encourages rapid development.

Early infestations are almost impossible to detect since there are no external signs. The larvae, when boring in the wood, make a rhythmic ticking or rasping sound much like that of a mouse gnawing. The borers tunnel very closely to the surface but seldom break through. The surface may bulge out due to packed frass. These bulged or blistered areas are best discovered by shining a light parallel to the surface. After the adults have emerged, there may be small piles of frass beneath or

on top of the infested wood. The frass, which is loosely packed in the tunnels, is composed of very fine powder and tiny, elongate, blunt-ended pellets that often split lengthwise when dry. The exit holes are oval and 1/4 to 3/8 inch in diameter. Robing the wood surface sometimes exposes the damage. The sapwood may be completely destroyed leaving only a paper thin surface of wood. The galleries have a rippled pattern like sand over which water has washed. In centrally heated houses without moisture problems, the borers seldom do excessive damage. The damage is generally restricted to a few boards. Serious damage occurs where enough humidity or moisture exists for reinfestations to occur.

Buprestids, also known as the flat-headed borers or metallic beetles, are a common type of wood borer which attacks weakened, injured, dead or dying trees and freshly cut logs of both hardwoods and softwoods. They seldom attack dry wood. The larvae have a flattened area behind the head and the beetles have beautiful markings and metallic colors. They are found throughout the contiguous states and the tropics. The borer rarely emerges from within a building, and there is no danger of serious damage to structural timbers. However, the flat-headed borer should be recognized for the type of damage it can do before the wood is put into service.

Wood damaged by flat-headed borers has winding tunnels that are extremely flat, and three to four or more times as wide as high. Since the wood is usually sawed after the damage has occurred, the tunnels are often cut at an oblique angle and their cross-sections are distorted (Figure 4-25). The tunnels are very tightly packed with layers of sawdust-like borings and pellets, and their walls are scarred with fine, transverse lines. The frass is somewhat like that of some round-headed borers, but the galleries are much more flattened. The tunnels of round-headed borers are no more than two to three times broader than high, and the frass is less tightly packed.

The galleries under the bark edges left on structural timbers are serpentine and wander over the surface of the outer sapwood. The borer will continue to develop, and can be heard chewing under the bark until the wood becomes too dry. The galleries are packed with a mixture of light, wood-colored frass and brown, bark-colored frass.

Exit holes made by the adults in the surface of the wood are sometimes present. They are elongate to oval, much like the exit holes made by some of the flattened long-homed beetles, such as the old house borer.

Curculionids are a family of beetles, some of which are known as the snout beetle or wood boring weevil. These beetles are not common, do not cause significant damage, but could be confused with anobiid beetles.

These beetles attack hardwoods and softwoods. When damage is heavy, the interior of the wood, including sapwood and heartwood, is honeycombed (Figure 4-26). They may be distinguished from the other beetles by the prolongation of the head into a snout.

Scolytids are known as bark beetles or engraver beetles, and range throughout

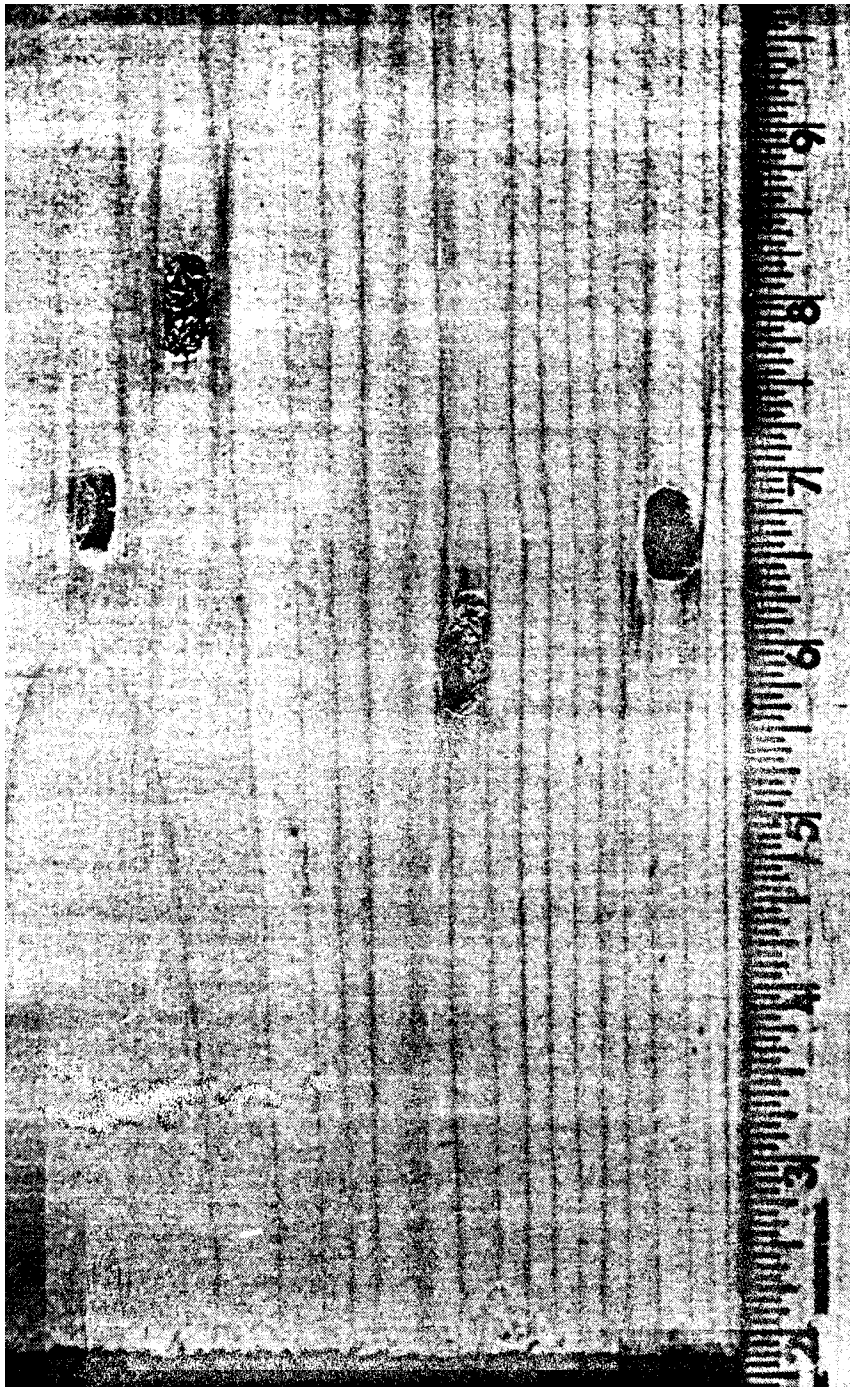

FIGURE 4-25

Buprestid or Flat-Headed Borer Damage to a Softwood Showing Rectangular Shaped Tunnels Cut at an Oblique Angle Indicating that the Damage was Done Prior to the Time the Log was Sawed

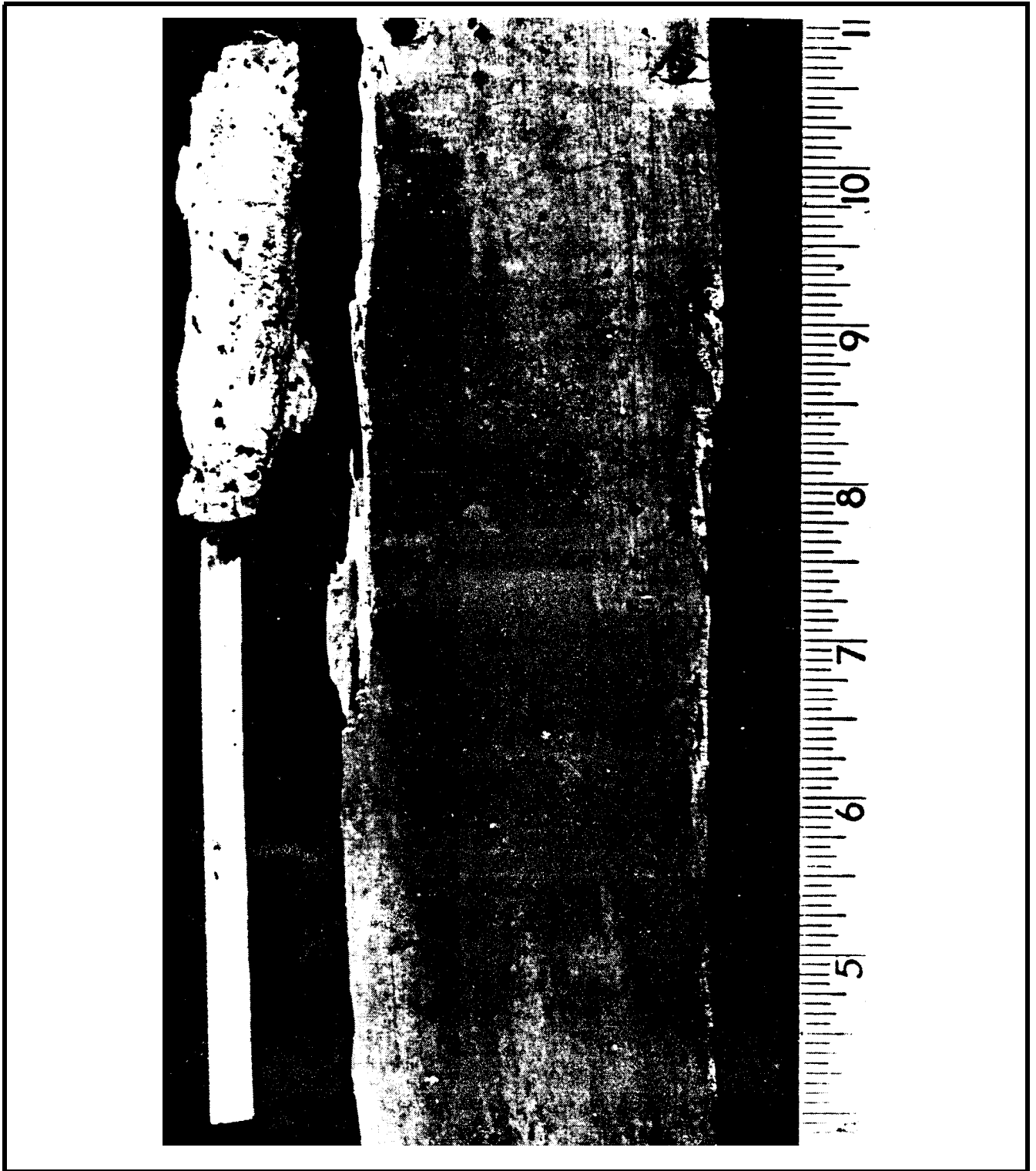

FIGURE 4-26
Damage to a Hardwood by Curculionids also known
as Snout Beetles or Wood Boring Weevils

the country. They do not cause any serious structural damage to wood in use, but since they can be present in both hardwood and softwood products with some bark on, they should be recognized. The beetles may survive in sawed lumber for a year or more, or until the wood is dry.

The female lays eggs in a gallery constructed in the cambium. The larvae tunnel away from the egg gallery. The galleries increase in size and become tightly packed with frass. Only the surface of the wood is slightly etched by these tunnels (Figure 4-27). Bark beetles pupate at the ends of the tunnels. The adults emerge from the pupal stage and tunnel straight out through the bark. The surface of the bark is sometimes riddled with round exit holes 1/16 to 1/8 inch in diameter. The beetles are brown, reddish-brown, or black, no more than 1/8 inch long, cylindrical, robust, and the head is partially or completely concealed from above. Bark beetles cannot live in seasoned wood, so there is no reinfestation.

Ambrosia beetles do not attack dry wood, but their damage can be seen as small tunnels, surrounded by stained wood in both hardwood and softwood lumber. The damage usually does not affect the strength of the wood.

The adult beetles bore 1/50 to 1/8 inch-diameter tunnels straight for several inches into the wood of trees or green logs and throw out all of the frass. Once inside the sapwood, the tunnel may branch and follow the curvature of one or more annual rings, or it may be unbranched and relatively straight. There also may be short side tunnels of the same diameter that follow the grain and where larvae feed and later pupate.

As the tunnels are constructed, the walls are inoculated with a fungus by the adult beetles. The fungus stains the gallery walls black, blue, or brown (Figure 4-28). The staining often spreads through the surrounding wood and is particularly obvious in lighter-colored species. The beetles will continue to infest the wood as long as it remains moist, but attack ceases when the wood dries out. Upon drying, the wood can be used without further deterioration.

4.3.5.2 Prevention and Control. Control procedures are based on three approaches. These are 1.) eliminate or reduce the beetle population, 2.) use naturally durable wood, or use a chemical treatment to protect susceptible wood, and 3.) control environmental conditions in the wood to retard development of the beetles or larvae.

For the beetles that begin their attack under the bark, the removal of any bark edges is a good preventive measure. Many of the round-headed and flat-headed borers feed under the bark for extended periods before they enter the wood. The bark beetles confine their attack to the inner bark, and are thus eliminated by bark removal.

Before sawn wood is purchased or placed into service, it should be inspected. If an active infestation is suspected, the wood should be heat sterilized before leaving the manufacturing plant. Table 4-5 gives the times and temperatures required to kill lyctid beetles and most other borers. For bostrichid beetles higher temperatures should be used.

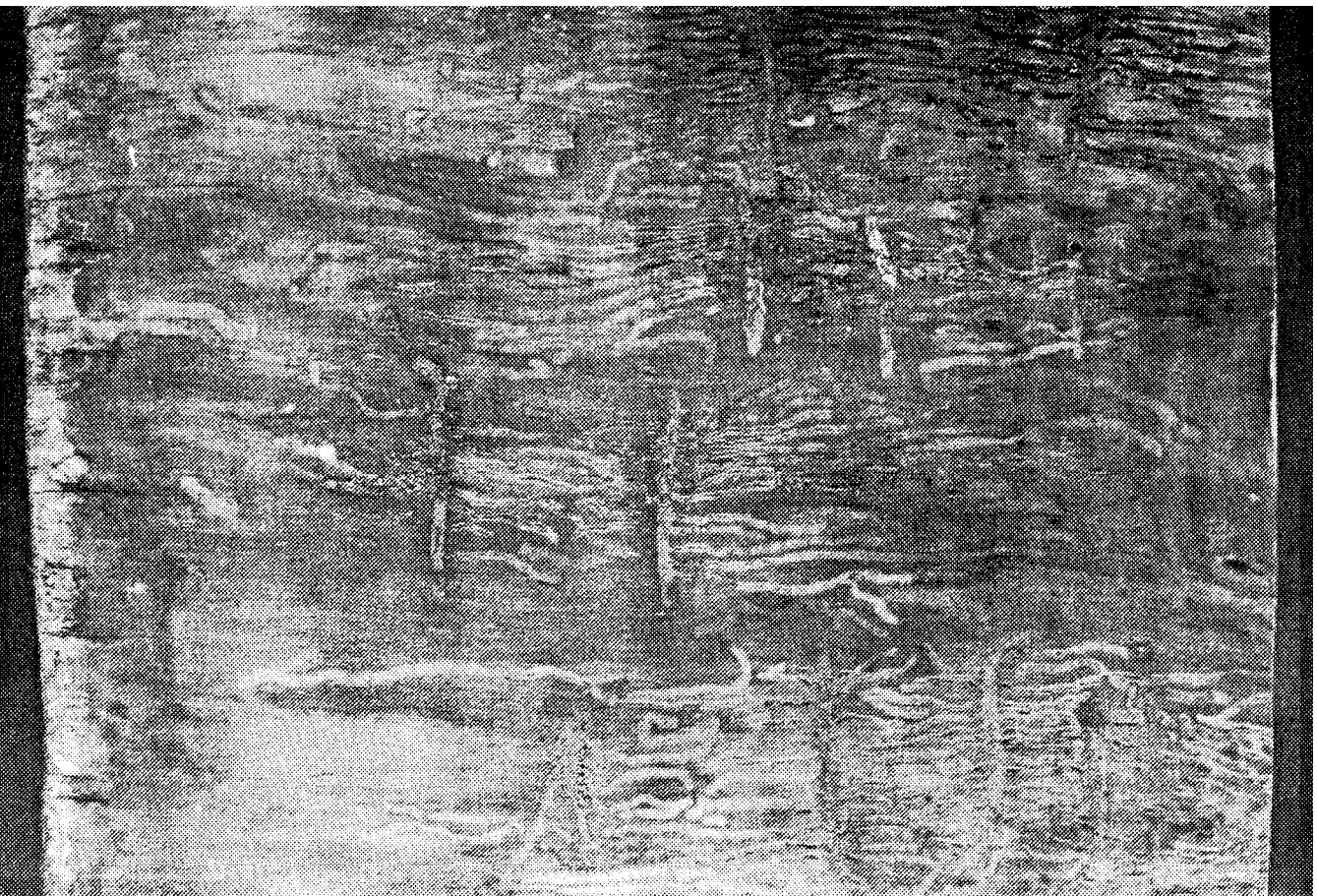

FIGURE 4-27
Scolytid or Bark Beetle Damage to Ash

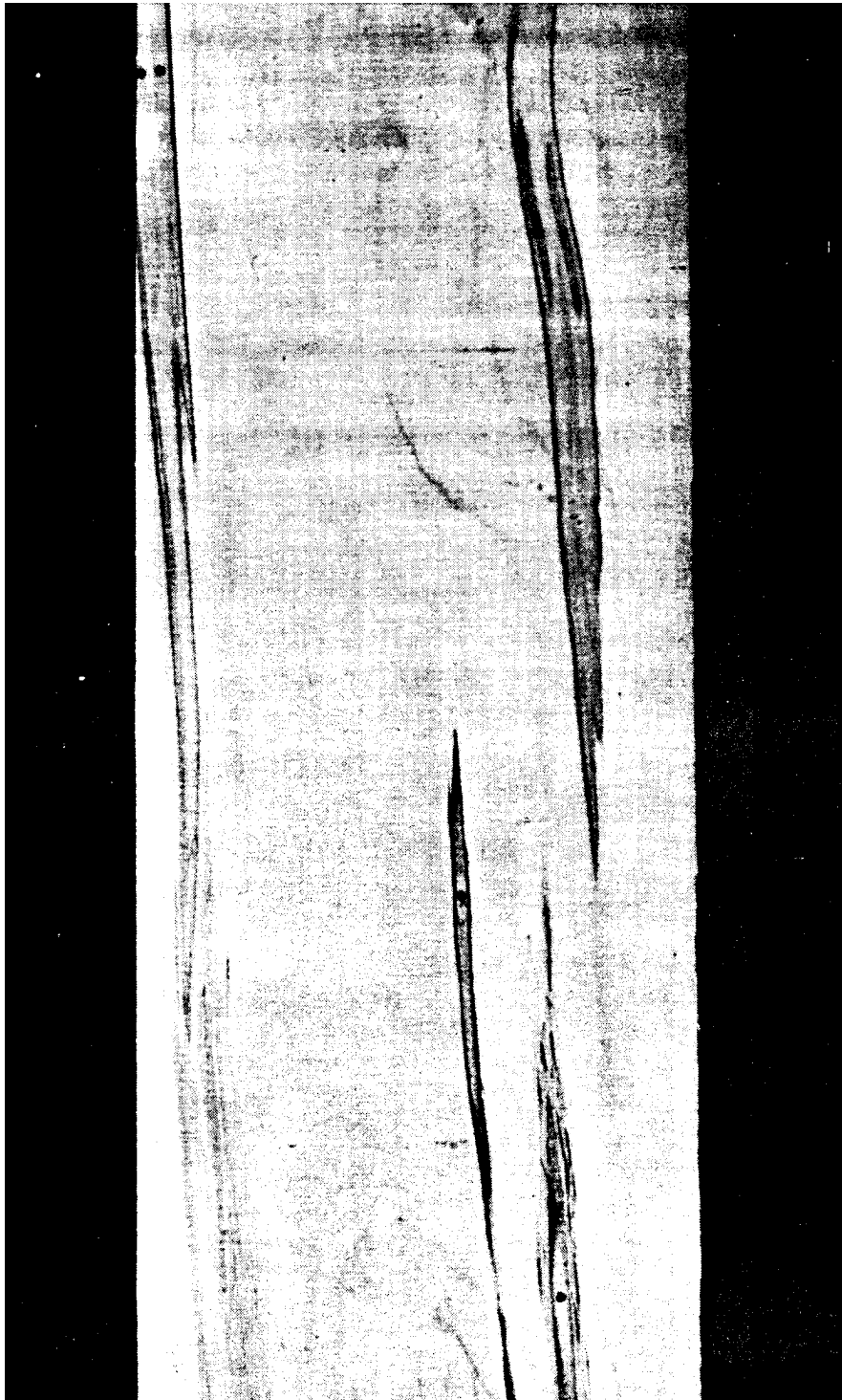

FIGURE 4-28
Ambrosia Beetle or Columbian Timber Borer Damage to Soft Maple

TABLE 4-5

Schedule for Heat Treating Wood
to Control Damage by Powderpost Beetles

Relative humidity	Lethal temperature required	Thickness of timber	Time required to overcome lag after kiln has attained lethal temperature	Additional margin of safety	Time then held at lethal temperature	Total period of exposure after kiln has attained required conditions
Percent	F	Inches	Hours	Hours	Hours	Hours
100	130	1.00	.50	.50	1.50	2.50
		2.00	2.00	.50	1.50	4.00
		2.50	3.25	.50	1.50	5.25
		3.00	4.50	.50	1.50	6.50
	125	1.00	.50	.50	2.00	3.00
		2.00	2.00	.50	2.00	4.50
		2.50	3.25	.50	2.00	5.75
		3.00	4.50	.50	2.00	7.00
80	120	1.00	.50	1.50	6.00	8.00
		2.00	2.00	1.50	6.00	9.50
		2.50	3.25	1.50	6.00	10.75
		3.00	4.50	1.50	6.00	12.00
	115	1.00	.50	7.50	30.00	38.00
		2.00	2.00	7.50	30.00	39.50
		2.50	3.25	7.50	30.00	40.75
		3.00	4.50	7.50	30.00	42.50
	125	1.00	.50	1.00	4.00	5.50
		2.00	2.00	1.00	4.00	7.00
		2.50	3.25	1.00	4.00	8.25
		3.00	4.50	1.00	4.00	9.50
60	120	1.00	.50	2.00	7.00	9.50
		2.00	2.00	2.00	7.00	11.00
		2.50	3.25	2.00	7.00	12.25
		3.00	4.50	2.00	7.00	13.50
	115	1.00	.50	9.00	36.00	45.50
		2.00	2.00	9.00	36.00	47.00
		2.50	3.25	9.00	36.00	48.25
		3.00	4.50	9.00	36.00	49.50

Pressure treatment with preservatives will prevent beetle attack, as well as termite infestations. Diffusion treatments with boron also protect wood from attack by beetles. Brushing or spraying wood with residual insecticides has been used to control beetles. For current information on acceptable insecticides, the Engineering Field Division (EFD) Applied Biologist should be consulted.

The use of good building design will also help control beetles. Good ventilation in crawl spaces and attics, good drainage and proper clearance between wood and soil will help to reduce the equilibrium moisture content of wood in buildings, and, thus, create conditions less favorable to beetle development.

It has been a common practice when treating for old house borers to drill heavy timbers at frequent intervals and attempt to force in insecticide under pressure. Absorption of the chemical is erratic. Thus, the effectiveness of this procedure is questionable.

Fumigation quickly and completely controls infestations of wood-boring beetles whether the wood is in storage or service. In addition to acting rapidly, fumigants are useful when an infestation is very extensive, or is in building locations that make other control procedures impractical. Because of the current uncertainty over the availability and use of residual insecticides, and the large turnover in home ownership requiring certification that structures are insect-free, fumigation has recently become a more common control procedure. Sulfuryl fluoride is the fumigant widely used for the control of wood-boring beetles in houses. Fumigation is an expensive process, and it offers no residual protection from reinfestation. In addition, it is necessary for the residents to leave the premises for one or more days.

4.3.6 Carpenter Bees. Carpenter bees are found throughout the United States and are similar to bumblebees. They nest in wood structures and are more of a nuisance than a serious problem.

Carpenter bees usually choose wood that is soft and easy to work. They particularly like redwood, cypress, cedar, white pine, and southern yellow pine. Bare unpainted wood is preferred; lightly painted or stained wood is also subject to attack. They also will tunnel wood that has been lightly pressure-treated for above ground use with water borne preservatives.

The only external evidence of attack is the entry holes made by the females. The original entry hole is perfectly round and approximately 1/2 inch in diameter. The tunnel turns abruptly at a right angle after being extended approximately the length of the bee's body across the grain of the wood. The tunnel is extended with the grain from 4 to 6 inches in a new site and is smooth walled (Figure 4-29). Frass accumulates on surfaces below the site of activity. Frass is usually the color of freshly sawed wood, and varies with the species of wood under attack. There are no fragments of insects mixed with this frass as with the carpenter ants.

An old gallery may be extended or used without further burrowing. When an old gallery is

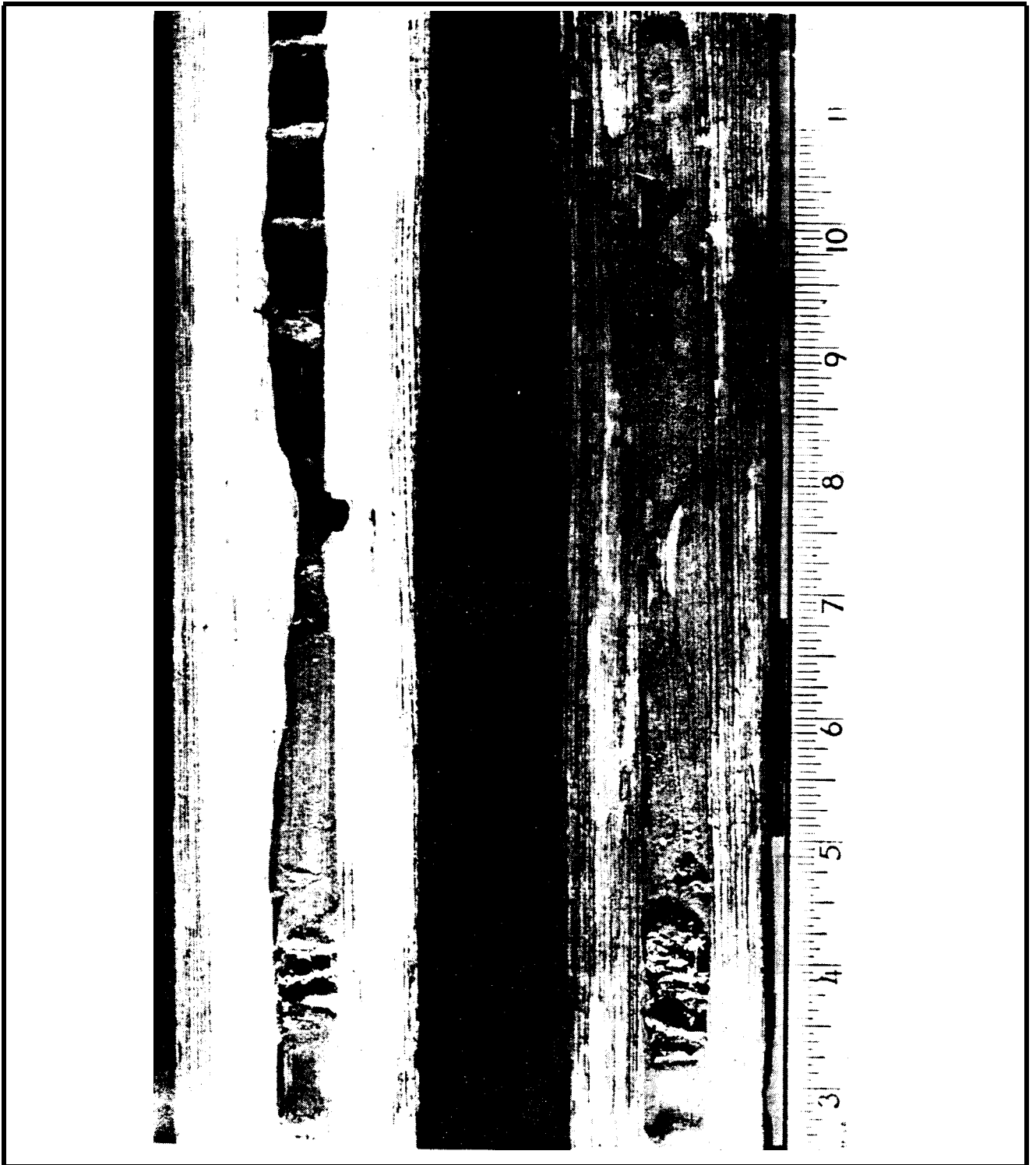

FIGURE 4-29
Carpenter Bee Damage in Redwood Showing a Single Entry Hole
(from inside) at the Top Center and Individual Cells (right)

repeatedly used by succeeding generations, it may ultimately reach 6 to 10 feet in length.

Damage from carpenter bees can be prevented by keeping wood surfaces well painted. Interior unpainted surfaces should be protected by keeping windows and doors closed or screened during the spring and early summer when the bees are looking for a nesting site.

Wood pressure-treated with organic preservatives, such as pentachlorophenol, or with heavy loadings of water borne preservatives, is resistant to carpenter bee attack. Even surface coatings of organic preservatives are helpful. In order to maintain the repellent effect, the surface should be retreated when it has weathered for several years.

Five to 10 percent carbaryl (Sevin) dust, or any insecticide labeled for bee control, applied into the entry holes will kill bees which come into contact with the residue. Several days after treatment, the holes should be plugged with short lengths of dowel rod of the proper diameter, or with plastic wood. Plugging the holes without applying insecticide can lead to the production of new holes next to the plugs when bees inside attempt to emerge, or nesting females seek re-entry into galleries in use.

Treating the external surfaces in the vicinity of the entry holes with 0.5 percent lindane oil solution, or with any insecticide labeled for bee control, will discourage continued bee activity for the season.

4.4 MARINE BORERS. Marine invertebrates which bore into and, consequently, damage timber in salt or brackish water are called marine borers. Marine borers are serious pests in wooden waterfront structures (Figure 4-30) and have damaged wooden vessels throughout history. A summary of the characteristics is given in Table 4-4.

The marine borers which cause the greatest amount of damage can be divided into two main groups. Members of the phylum Mollusca constitute one group. These organisms are shell animals like clams and oysters. The Molluscan borers are further divided into two families. Teredinidae which contain the genera *Teredo* and *Bankia* are commonly called wood-boring shipworms. The second family is called Pholadidae and includes the genus *Martesia* and resembles clams and is commonly referred to as Pholads or rock boring piddock. The second major group belongs to the phylum Crustacea and are related to the lobsters and crabs. *Limnoria* and *Sphaeroma* are important wood-destroying genera. *Limnoria* are commonly referred to as gribbles.

Marine borers vary greatly in their distribution (Figure 4-31) and ability to destroy wood. They are generally more destructive in tropical waters. Their population can rise and fall depending on any number of factors such as salinity changes due to floods or other causes, water temperatures, and dissolved oxygen content. There is some indication that marine borer populations increase as pollution levels decline. Because of this variation, it is always best to consult local authorities before initiating control procedures.

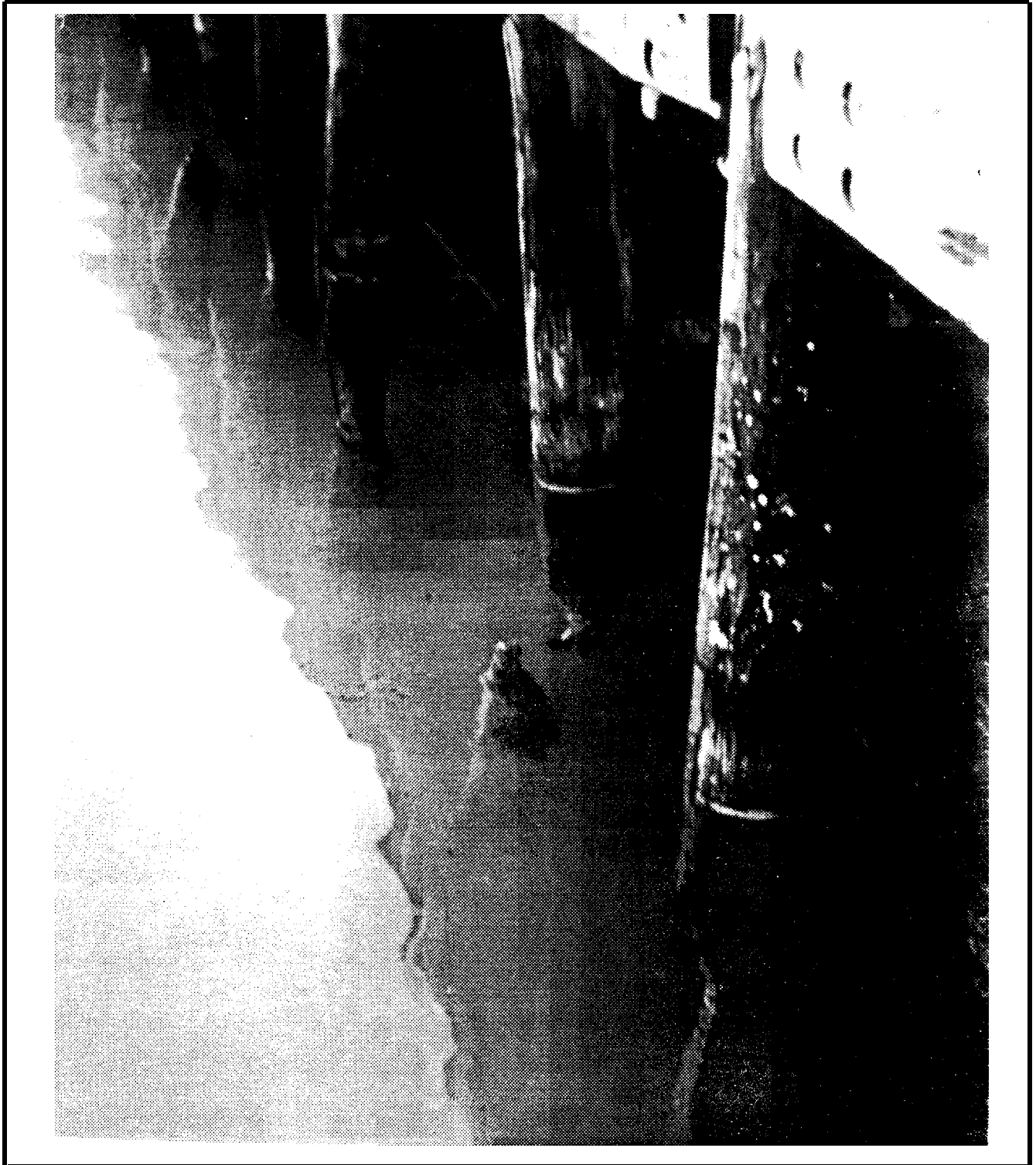

FIGURE 4-30
Extensive Damage to a Wooden Waterfront
Structure from Marine Borers (*Limnoria*)

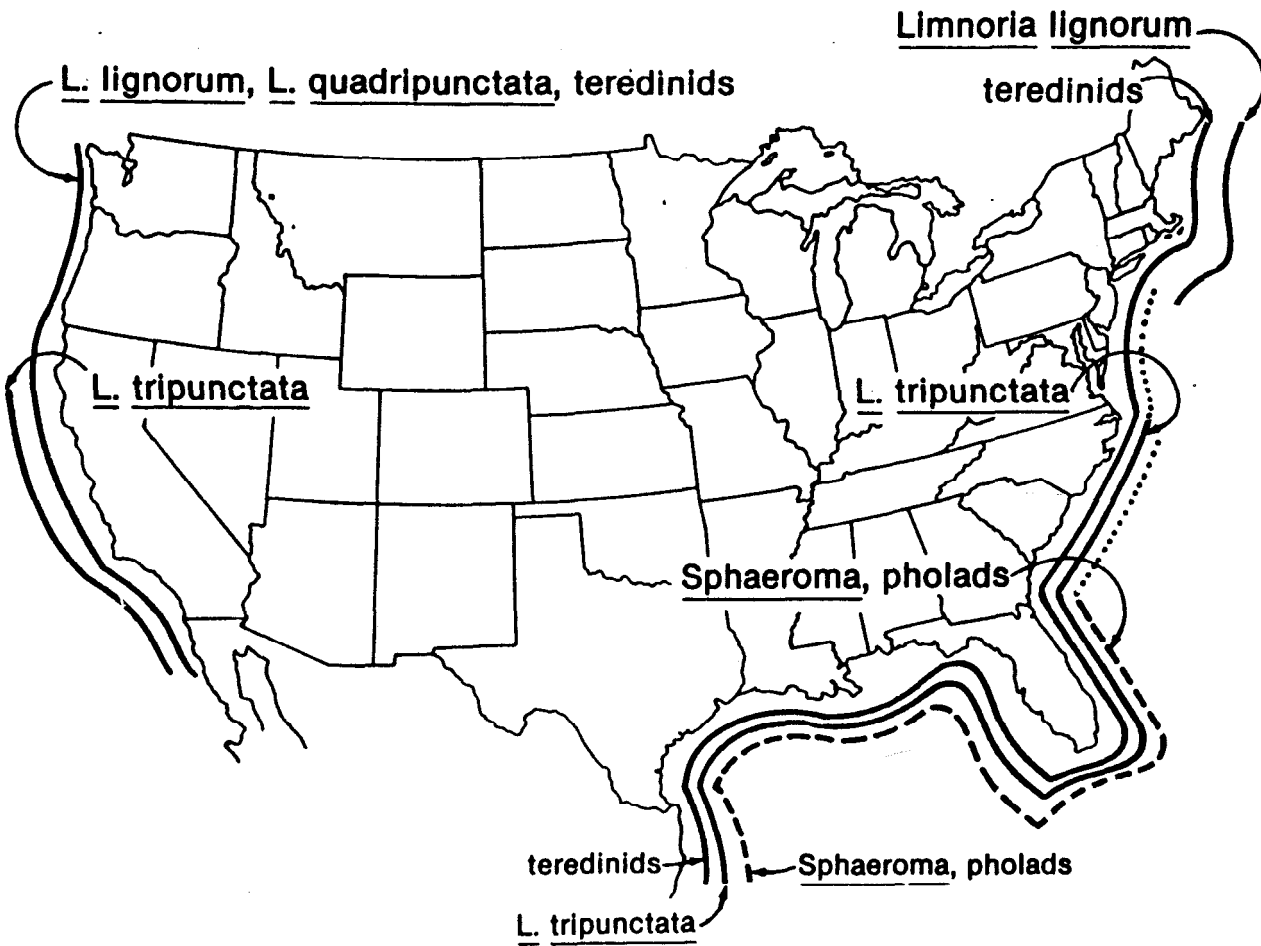

FIGURE 4-31
Distribution of Marine Borers in the United States

4.4.1 Mollusca.

4.4.1.1 Teredo. Teredo, also called shipworms or Teredinids, have a worm-like appearance. They are notorious for causing extensive damage to wooden ships and other wooden waterfront structures. Surface damage is minimal, but once inside a wood member, it can be completely honeycombed (Figure 4-32) in a short time period.

Teredo reproduce from eggs which are fertilized within the female. The eggs develop into microscopic free-swimming larvae which are able to move about in the water or over the surface of submerged wood in search of suitable new locations to begin boring.

Boring is done by the mechanical rasping action of a pair of shell-hardened valves equipped with fine teeth on the head of the animal. The wood is partially digested to supplement the food furnished by other organisms. The posterior of the body has two siphons which extend into the water. The incurrent siphon draws in water containing microscopic organisms for food and dissolved oxygen for respiration. The excurrent siphon expels waste products.

An entrance hole about 1/16 inch in diameter is bored into the surface of the wood by the young larvae. Thus, it is difficult to detect their presence or extent of damage from the surface of the wood. Attack is frequently concentrated at the mud line. The larvae enter the wood at right angles to the grain and then burrow with the wood grain in the longitudinal direction, following a very irregular course, turning to avoid unfavorable sections such as knots. Once inside the wood, the larvae develop wormlike bodies rapidly and remain imprisoned in the wood for life. Adults may be one to two feet in length and one-half inch in diameter. The wall of the hole is lined with a shell-like (calcareous) deposit. When the animal's siphons are withdrawn from the water into the hole, the opening is plugged with small calcareous pellets. These borers may completely honeycomb a piece of wood, yet the surface will show only slight damage due to the small entrance holes.

Shipworms are found in all coastal waters of the United States. Teredo are capable of withstanding broad changes in salinity, thus they can also be found in the upper reaches of many estuaries.

Shipworms are deterred by preservative treatments of 20 to 25 pounds of marine-grade creosote meeting AWWA Standard P13-85 or creosote-coal tar meeting AWWA Standard P12-85 per cubic foot of wood, or 2.5 pounds of ACA or CCA per cubic foot of wood.

4.4.1.2 Bankia. Bankia are very similar to Teredo with a few exceptions. First, in their life cycle, the egg is ejected into the water and fertilized there. Larvae capable of swimming develop within a few hours, but they do not attack the wood for approximately one month. The adults may be up to five or six feet long and 7/8 inch in diameter.

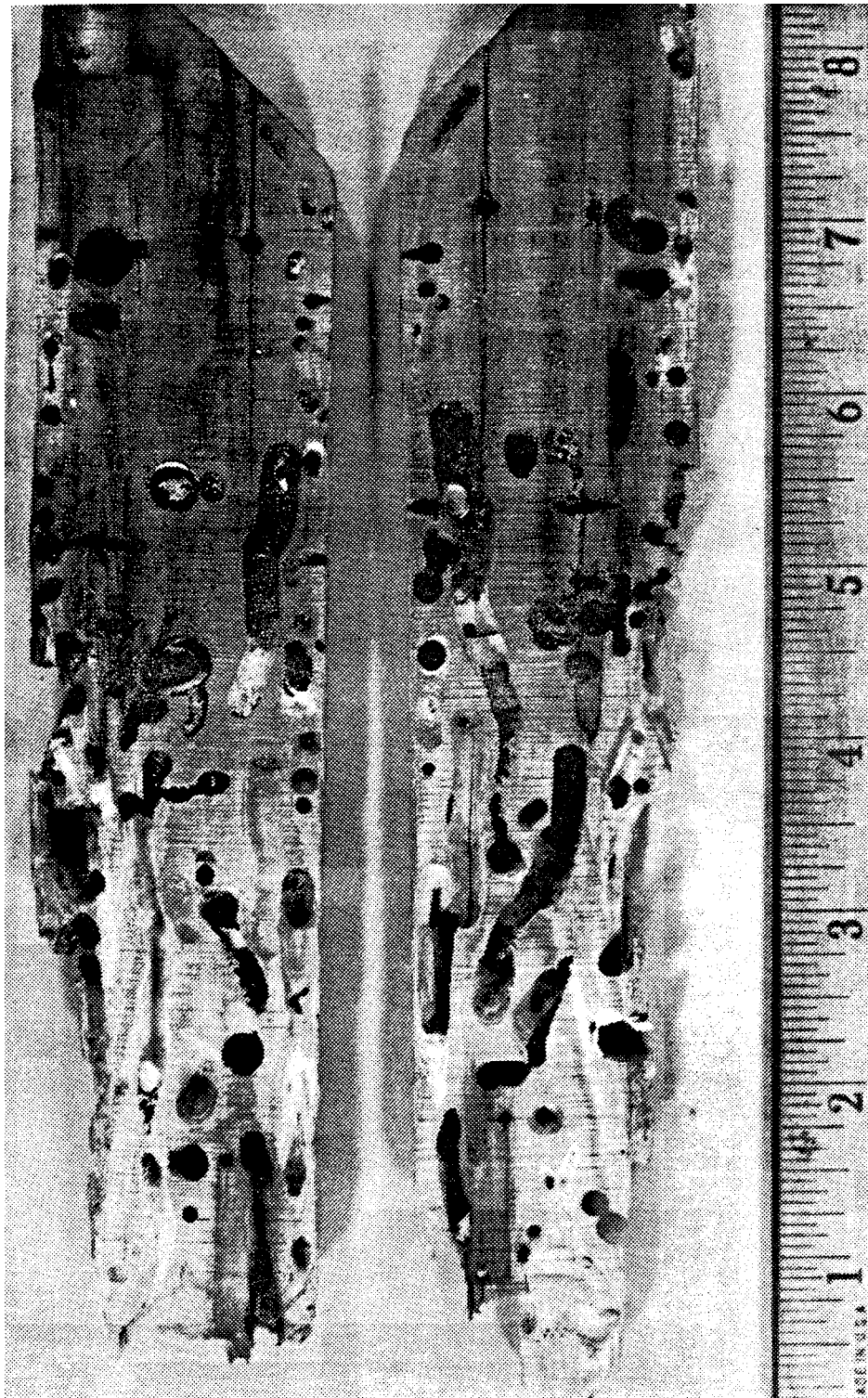

FIGURE 4-32
Shipworm Damage

4.4.1.3 Martesia. *Martesia*, also called Pholads, rock borers or rock-burrowing clams, resemble clams. They have a pear-shaped body, which is entirely encased within the bivalve shell even in adult form. *Martesia* are generally not over two and one-half inches in length by one inch in diameter. Like the genera *Teredo* and *Bankia*, *Martesia* become imprisoned within the wood.

Martesia can bore in wood, clay, soft rock, shells, plastic and even poorer grades of concrete. The surface entrance hole is about 1/4 inch in diameter, and thus easier to detect than those of *Teredo* and *Bankia*. The bore holes may be two to two and one-half inches deep and up to one inch in diameter. Thus, most of the damage is close to the wood surface. The diameter of the hole increases as the organism develops and increases in size.

Martesia cause the most serious damage in tropical waters. On the east coast they are found from South Carolina southward and become economically destructive in Florida. They cause serious damage in Hawaii and Mexico. They are also reported to be found on the Oregon beaches, but are not a serious pest there.

Martesia attacks can be precluded by treating with 20 to 25 pounds of marine-grade creosote or creosote-coal tar per cubic foot of wood or by treating with 1.0 to 1.5 pounds of ammoniacal copper arsenate (ACA) or copper chrome arsenate (CCA) per cubic foot of wood; dry; and with 20 pounds creosote or creosote-coal tar per cubic foot of wood (dual treatment).

4.4.2 Crustacea.

4.4.2.1 Limnoria. *Limnoria*, also called gribbles, are serious marine pests that can cause extensive damage. However, their damage is generally visible and thus not as spectacular as the shipworms. Furthermore, one species, *Limnoria tripunctata* (Menzies), found in temperate and subtropical regions, is tolerant of creosote. The other two species *L. lignorum* (Rathke), found worldwide in cool to temperate climates, and *L. quadripunctata* (Holthuis), found in temperate waters of the Pacific coast, are not creosote tolerant.

Limnoria reproduce by means of eggs carried in a brood pouch on the underside of the body. Between 6 and 17 eggs are contained within a single brood. When hatched within the parent burrow, the young differ from the adult only in size, and are able to bore at once. The mature adults are one-eighth to one-fourth inch long. They are one-third as wide and resemble a wood louse or sow bug. The body is segmented and has seven pairs of legs with sharp hooked claws which enable it to move and to cling firmly to a wood surface. It also has a thin platelike appendage (gills) which is used for respiration and limited swimming. The ability to swim allows the animal to leave its burrow at will, and to move to new wood sources. The mouth parts include a pair of strong mandibles designed for chewing wood. The wood is used for food along with other marine fungi and possibly bacteria. The body ends in a broad tail which is used to close the burrow to intruders.

Limnoria bore holes about one-sixth inch in diameter and seldom go more than one-half inch below the wood surface, and may run obliquely for one inch or more. Earlywood is preferred. Wood is normally heavily infested and may contain 300 to 400 animals per square inch, and the surface of the wood will be severely honeycombed. The remaining thin wood partitions are broken away by wave or other mechanical action and new wood is exposed to further attack. The attack is usually concentrated between half tide and low tide levels, or at mud line where the eroding action is the greatest. A distinctive hourglass shape (Figure 4-30) results.

The spread of Limnoria is usually slow due to their poor swimming ability. However, water movement and driftwood can serve to spread them.

Limnoria are active along the entire coastal area of the United States. Their activity is accelerated in warm tropical waters where breeding occurs year around as compared to colder regions.

The method used to prevent Limnoria attack depends on which of the three species are present. This, in turn, depends somewhat on climatic conditions. *L. tripunctate*, which is destructive on the Pacific coast from San Francisco southward, on the Atlantic coast from North Carolina southward, and on the Gulf coast, is tolerant to creosote in these regions. This species may be extending its range northward, and it has also been shown that a population explosion can occur if the water temperature increases slightly. Two preservative treatments are recommended. One is a dual treatment which consists of treating pilings with 1.0 to 1.5 pounds of ammoniacal copper arsenate (ACA) or copper chrome arsenate (CCA) per cubic foot of wood; drying the wood; and then treating with 20 pounds of marine-grade creosote or creosote-coal tar per cubic foot of wood. An alternative treatment is to use 2.5 pounds of ACA or CCA per cubic foot of wood.

Treatments for the other two species (*L. lignorum* and *L. quadripunctata*) found in temperate or cold waters consists of using 20 to 25 pounds of marine-grade creosote or creosote-coal tar per cubic foot of wood or 2.5 pounds of ACA or CCA per cubic foot of wood.

4.4.2.2 Sphaeroma. Wood boring species of Sphaeroma (principally *S. terebrans*) are found in some, usually brackish, waters along the southeast and gulf coasts and, to a lesser extent, on the west coast from San Francisco southward. They are most common in Florida estuaries, but even there, their occurrence is spotty and unpredictable. They seem to be particularly tolerant of CCA and ACA. Creosote seems to resist attack better but with time becomes susceptible.

The borers are similar to Limnoria, except they are larger and stouter reaching a length of 3/8 to 1/2 inch long and 1/4 inch wide. The burrows are typically 1/4 inch in diameter, generally perpendicular to the timber surface, and usually go to a depth of about three times the diameter (Figure 4-33). Softer species of wood are preferred. Heavily attacked wood surfaces are often honeycombed. The wood is used for shelter and probably not ingested.



FIGURE 4-33
Sphaeroma and Associated Damage

CHAPTER 5. PRESERVATION OF NEW WOOD PRODUCTS TO PREVENT DECAY AND INSECT ATTACK

5.1 NEED FOR PRESERVATIVES. In the past “naturally durable” woods, such as green heart, cypress, redwood and cedar were used where decay fungi, insects or marine borers were a threat. As discussed in Chapter 2, the availability of these woods is now limited and they are generally more costly than treated wood products. Consequently, most wood is now treated with preservatives to protect it from degradation by decay fungi, insects and marine borers. Preservatives are applied to wood by nonpressure processes that provide superficial protection and by pressure processes that force chemicals into wood.

5.2 SUPERFICIAL TREATMENTS. Preservatives applied by brushing, spraying, dipping or vacuuming processes do not penetrate deeply into the wood. These treatments are not intended to protect the wood from sustained exposure to degrading organisms.

No commercial standards govern the use of preservatives applied by brushing or spraying. Dip treatments of exterior millwork, such as doors and windows, with water-repellent preservatives (WRP) and non pressure treatments for wood packaging for the DOD are described in either commercial or U.S. government standards.

Water-repellent preservatives contain a wax, resin and other components to cause wood to shed (repel) water, and a preservative to prevent decay.

5.2.1 Treatment Quality. To meet standards set by the National Wood Window and Door Association, water-repellent preservative treatments for millwork must reduce the normal shrinking and swelling of wood by at least 60 percent and must leave the surface of the wood clean, dry and paintable. Preservatives included in water-repellent formulations must be effective in preventing decay.

5.2.2 Non Pressure Methods Of Application.

5.2.2.1 Brush. Brush treatments should be flooded onto the surface and not brushed out thin, like paint. Checks and other openings should be saturated to the point of refusal. The wood should be well dried before treatment or it will not accept preservatives applied in this manner.

5.2.2.2 Spray. A coarse spray should be used to minimize health hazards. Special precautions should be taken to avoid drift.

5.2.2.3 Dip. Dip treatment involves immersion of wood materials in a tank of preservative until the wood absorbs the appropriate amount of solution. The NWWDA requires a soaking period of 15 seconds when individual parts or units are treated and 3 minutes for batches or

bundles of exterior millwork. DOD specifications usually require at least a one-minute dip treatment.

5.2.2.4 Vacuum. The preservative is applied in a chamber in which air has been exhausted with a vacuum pump. After the preservative enters the chamber and the vacuum is released, air at atmospheric pressure increases penetration.

5.3 IN-DEPTH TREATMENTS. Pressure and other in-depth treatments are used for wood that is subject to severe exposure.

5.3.1 Treatment Quality. Standards for pressure treated wood define minimum depths of preservative penetration and minimum levels of preservative retention.

5.3.1.1 Penetration. Penetration is the depth to which the preservative is forced into the wood. Penetration is the simplest measure of treatment quality because deep penetration contributes to good protection. If penetration is shallow, the preservative shell is easily broken by checking or other mechanical action and the unprotected wood beneath the shell is subject to deterioration (Figure 5-1).

5.3.1.2 Retention. Retention is the amount of preservative within a specified volume of wood. Retention is usually defined for wood at specific depths from the surface of the treated wood product. This zone is commonly referred to as the “assay zone”.

5.3.1.3 Standards. The American Wood Preservers Association publishes standards for pressure and thermal treatment of wood. These standards vary by commodity type, intended end use, and species. The amount of retention and penetration are specified for each commodity in specific standards. Minimum quality control requirements are cited under each standard.

5.3.2 Pre-treatment Processing. The ways in which wood products are processed prior to preservative treatment can influence the penetration and retention of the preservative.

5.3.2.1 Debarking. Removal of bark before treatment is essential. Remaining bark prevents preservative penetration and encourages wood boring and decay organisms.

5.3.2.2 Drying. Wood must be dried before treatment to obtain satisfactory penetration and retention of preservative. The most common techniques are:

Air Drying. Air drying is the simplest method. Wood is stacked with adequate room for air to circulate around each piece allowing water to evaporate from it.

Kiln Drying. Wood products are also dried in kilns. Dry kilns are



FIGURE 5-1

Deep Checks or Cracks in Treated Sapwood have
Allowed a Fungus to Penetrate and Decay
the Untreated Interior of this Pole

simply large ovens used to accelerate the drying of wood without producing defects. The temperature, humidity and air velocity in the kilns are controlled.

Steam Conditioning. Wood in a treating cylinder is subjected to live steam at 220-245°F for one to twenty hours followed by a vacuum. Moisture is removed during the vacuum period. Unfortunately, steaming can also reduce wood strength. Therefore, the maximum allowable steaming temperatures are defined in standards.

Vapor Drying. This method exploits the principle that energy lost in the condensation of hot organic vapors on wood can be used, to evaporate water from wood in a treating cylinder. The drying agent, an organic compound, is pumped into the cylinder and heated, water from the wood and organic (drying agent) vapors are transferred to a condenser where they are separated and the drying agent is recycled.

Boultonizing. This drying method is accomplished in a treating cylinder by heating wood in creosote or an oil type preservative while subjecting it to a vacuum. Water will boil at less than 212°F because the wood is under vacuum. Therefore, this process uses temperatures below those required in the steaming and vacuum process.

Incising. Incising is the production of small slits or holes in the surface of wood products to facilitate deeper and more uniform penetration of preservative (Figure 5-2). Incising requirements for different species and commodities are given in AWWA standards.

Machining and Cutting. Where possible, all machining such as boring, framing or dapping of timber, gaming and boring pole tops, cutting, etc., should be done prior to the preservative treatment to reduce exposure of untreated portions of the wood to decay fungi and insects.

5.3.3 Treating Methods. Pressure treating is the most commonly employed method to obtain deep penetration of wood preservatives. Other methods include hot-and-cold baths, diffusion and cold soaking.

5.3.3.1 Pressure. Pressure treatments are done in retorts, or closed cylinders (Figure 5-3).

Pressure processes can be divided into two categories.

- **Full Cell Process.** This process is commonly used with oil borne treatments for marine piling where high retentions are required and with water borne solutions of preservative salts.
- **Empty Cell Process.** The empty cell process impregnates and coats the cell walls with preservative without filling the cell lumens. This process provides the deepest penetration

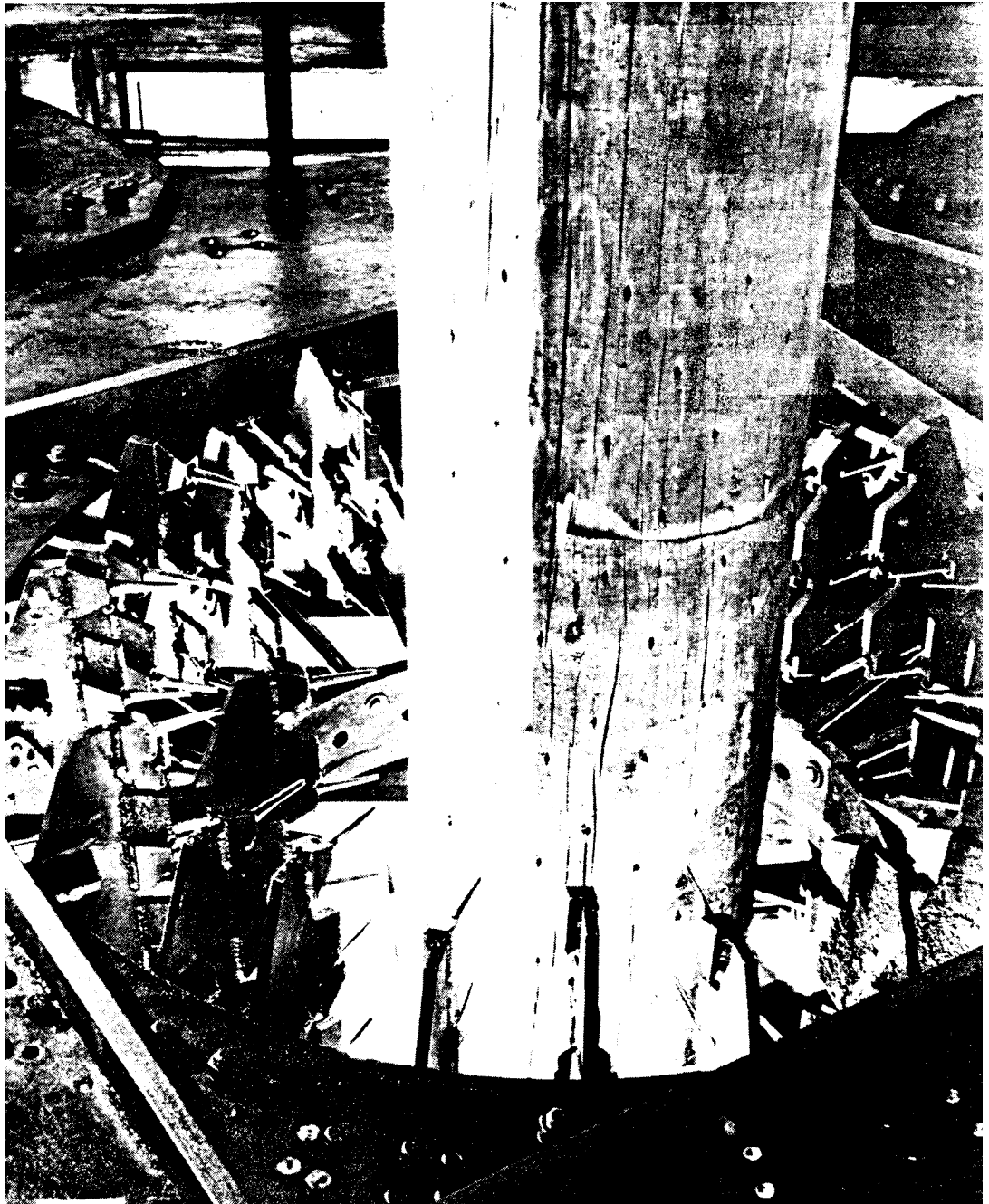

FIGURE 5-2
Incising Improves the Treatability of Refractory Woods
such as Douglas-Fir



FIGURE 5-3
Typical Treating Cylinder with Charge Ready for Processing

with low retention of preservative. The Reuping and Lowry are two empty cell processes commonly employed.

5.3.3.2 Hot and Cold Bath or Open Tank Treatment. The process is most commonly used for treatment of poles and fence posts. Wood is first immersed in a hot bath of preservative, then moved to a cold or cooling bath.

5.3.3.3 Diffusion. Deep penetration of unseasoned wood with water soluble preservatives is achieved when wood is soaked for days or weeks in tanks of preservative chemicals.

5.3.4 Preservative Chemicals. Wood preservatives must be effective against wood-destroying organisms, yet safe from an environmental and health standpoint for the end use intended.

Commonly used preservatives can be divided into two groups. The first group is the organic preservatives such as creosote, oil borne pentachlorophenol, copper naphthenate and others. The second group includes the water borne salts.

5.3.4.1 Organic Preservatives. This group contains creosote and coal tars, pentachlorophenol, bis (tri-N-butyltin) oxide, and copper naphthenate.

Coal Tar Creosote and Related Products. The words coal tar creosote and creosote are used interchangeably. This preservative is commonly used on piles, poles, heavy timbers and railroad ties. It imparts a dark brown to black color. Creosote is effective against most biological organisms that attack wood. It is permanent due to low volatility and it is insoluble in water. However, freshly creosoted wood may ignite easily. Also, the odor and oily dark surfaces of the treated wood may be objectionable. Creosoted material cannot be painted. In November of 1986, it became a restricted use pesticide and is available only to certified applicators.

Pentachlorophenol. Pentachlorophenol has been widely used in both an oil and water-soluble form for pressure and non-pressure preservative treatment of wood. As of November 1986, however, it is a restricted-use pesticide and thus available only to certified applicators.

Solutions of 5 percent pentachlorophenol in light petroleum solvents such as kerosene, mineral spirits and similar oils are used for treating exterior millwork since they will leave a clean, paintable surface.

Pentachlorophenol is effective against many terrestrial wood destroying organisms such as molds, stain, decay fungi, and insects. However, it is not effective against marine borers and should never be used by itself for protection of wood in salt water. It should not be applied indoors or where human contact is likely.

Copper Naphthenate. Copper naphthenate is a mixture of naphthenic acids combined with copper salts to form a dark green mixture. It is not a restricted use pesticide and it is not considered a hazardous waste.

Copper naphthenate has a high toxicity to wood destroying fungi. For brushing and other superficial methods, a copper content of one to two percent (approximately 10 to 20 percent copper naphthenate) is usually required. The solution will generally impart a pronounced green color to the wood.

Zinc Naphthenate. Zinc naphthenate is similar to copper naphthenate, but it is not as toxic to wood destroying fungi. It is lighter colored and does not impart the characteristic green color of copper naphthenate.

Copper-8-Quinolinolate. Copper-8-Quinolinolate is green in color, odorless, is toxic to a wide range of wood destroying organisms and has a low toxicity to humans and animals. It is permitted by the U.S. Food and Drug Administration for treatment of wood used in food handling. It is used to treat commercial refrigeration units, fruit and vegetable baskets and boxes, greenhouse flats, water tanks and others. It has also been used on non-wood materials such as webbing, cordage, cloth, leather and plastics.

Bis (Tri-N-Butyltin) Oxide (tributyltin oxide or TBTO¹). This preservative has a lower mammalian toxicity, less skin irritation and better paintability than penta. TBTO is not effective against decay when used in soil contact and is only recommended for above ground use such as millwork.

5.3.4.2 Water Borne Preservatives. Water borne salt preservatives produce a dry to the touch (not oily), paintable surface, free from objectionable odor. Treated wood may show shades of brown or green color depending on the preservative and wood species. Water borne preservatives afford little protection to mechanical wear.

The common water borne preservatives are as follows:

- Acid Copper Chromate (ACC) (Celcure[®]).
- Ammonical Copper Arsenate (ACA) (Chemonite[®]). This preservative is used most commonly with refractory species such as Douglas-fir.
- Ammonical Copper Zinc Arsenate (ACZA).
- Chromated Copper Arsenate (CCA) (Type A, B, and C). Type A (Greensalt) is high in chromium, type B (K-33) is high in arsenic and Type C (Wolman) is intermediate. CCA should not be used in treatment of Douglas-fir.
- Chromated Zinc Chloride (CZC).

¹Trademark M&T Chemical Co.

5.3.5 Standards. The American Wood Preservers' Association produces consensus standards for the pressure treatment of wood with preservatives in the United States. A list of the standards is shown in Appendix A. The corresponding Government Services Administration (GSA) specification on processes for m-depth preservative treatment of wood is TT-W-571, Wood Preservation: Treating Practices (Appendix B), which is used in procurement through DLA/DCSC. Retention requirements of these standards are summarized in Table 5-1.

These standards and specifications spell out details regarding treatment of different commodities such as lumber, poles, piles, crossties, etc.; choice of preservatives; methods for analysis of preservatives; penetration and retention; and other critical aspects of the pressure treating of wood with preservatives. Therefore, they provide both producer and consumer with state of the art information and a common reference point when specifying treated wood material and checking quality.

5.4 CARE AND HANDLING OF TREATED WOOD. In addition to the proper selection of materials and treatment methods, certain precautions must be taken with treated wood products if the expected service life is to be achieved. They are:

5.4.1 Exposure Of Untreated Wood. All cutting, boring and other machining of wood should be done prior to preservative treatment as much as possible. Cutting treated wood at the construction site exposes untreated heartwood to wood destroying organisms. Examples might include the cutting off of piling tops, boring of heavy timbers, etc.

Untreated wood, exposed by cutting, etc., at the job site should be field treated. The same wood preservatives used to pressure treat commodities can often be used for treatment of field cuts or else a copper naphthenate solution containing a minimum of two percent copper metal can be used. For detailed information on preservatives and field application methodology, refer to AWWA M4 which includes all treated wood products.

5.4.2 Handling And Storage. Poles and piling treated with oil borne preservatives should be installed soon after treating to minimize lateral movement of preservative to the extent that subsequent durability of the treated product will be reduced. This is a particularly important consideration in procurement programs for poles that might normally be expected to be in transit or in storage for a minimum of one year.

Poles and piles treated with creosote or oil based preservatives stored in a horizontal position for over 18 months can lose preservative due to bleeding and volatilization or the preservative can migrate in the wood. To minimize this loss, poles and piling should be rotated periodically while in storage.

Migration or loss of preservative during storage is not a problem with water-borne preservatives.

TABLE 5-1

Wood Products and Usage, Preservative Types and Retentions,
and Applicable Standards*

MATERIAL AND USAGE	Creosote	Creosote - Coal Tar	Creosote - Petroleum	Pentachlorophenol	Pentachlorophenol - With light petroleum or volatile solvent	Acid Copper Chromate (ACC)	Ammoniacal Copper Arsenate (ACA)	Ammoniacal Copper Zinc Arsenate (ACZA)	Chromated Copper Arsenate (CCA)	Chromated Zinc Chloride (CZC)	AWPA Standards C1 and	Federal Specification TT-W-00571J	AWPB STANDARDS
--- Retention by Assay of Treated Wood--lbs./cu.ft. ---													
<u>TIES: Crossties, Switchties and Bridge ties</u>													
(Beech, Birch, Maple)	7.0	7.0	7.0	0.35							C2/C6	Table I	None
(Red Oak)	-- Treat to Refusal --										C2/C6	Table I	None
(Black and Red Gum)	10.0	10.0	10.0	0.50							C2/C6	Table I	None
(Ash, Black and Honey Locust, Hickory, Black Walnut, White Oak and Interior Douglas-fir)	-- Treat to Refusal --										C2/C6	Table I	None
(Coastal Douglas-fir, Western Larch, Southern and Ponderosa Pines, Western Hemlock)	8.0	8.0	8.0	0.40							C2/C6	Table I	None
(Jack and Lodgepole pines)	7.0	7.0	7.0	0.35							C2/C6	Table I	None
<u>TIMBERS</u>													
<u>COASTAL WATERS--WHERE:</u>													
Teredo, Limnoria, Pholads Present (See Dual Treatment at end)													
Limnoria Heavy, No Pholads (Central Douglas-fir, Western Hemlock and Southern Pine)						2.50	2.50	2.50			C18	Table I	MLP
Teredo Present, Limnoria Light (Coastal Douglas-fir, Western Hemlock and Southern Pine)	25.0					2.50	2.50	2.50			C18	Table I	MLP
Teredo Present, No Limnoria (Coastal Douglas-Fir, Western Hemlock and Southern Pine)	20.0										C18	Table I	MLP

TABLE 5-1--Continued

Wood Products and Usage, Preservative Types and Retentions,
and Applicable Standards*

MATERIAL AND USAGE	Creosote	Creosote - Coal Tar	Creosote - Petroleum	Pentachlorophenol	Pentachlorophenol - With light petroleum or volatile solvent	Acid Copper Chromate (ACC)	Ammoniacal Copper Arsenate (ACA)	Ammoniacal Copper Zinc Arsenate (ACZA)	Chromated Copper Arsenate (CCA)	Chromated Zinc Chloride (CZC)	AWPA Standards C1 and	Federal Specification TT-W-00571J	AWPB STANDARDS
--- Retention by Assay of Treated Wood--lbs./cu.ft. ---													
<u>TIMBERS (cont.)</u>													
<u>FRESH WATER OR GROUND CONTACT</u>													
Structural (Coastal Douglas-fir, Western Hemlock, Western Larch, and Southern Pine)	12.0	12.0	12.0	0.60			0.60	0.60	0.60		C2	Table I	<u>LP</u> 55, 77, 22
Non-Structural (Coastal Douglas-fir, Western Larch, Redwood, Western Hemlock, Jack, Red, Sugar, Northern white, Western White, Southern, and Ponderosa Pines)	10.0	10.0	10.0	0.50	0.62	0.50	0.40	0.40	0.40		C2	Table I	<u>LP</u> 55, 33, 44, 22
<u>ABOVE GROUND USE</u>													
(Coastal Douglas-fir, Western Hemlock, Western Larch, Redwood, Jack, Red, Lodgepole, Northern White, Sugar, Southern and Ponderosa Pines)	8.0	8.0	8.0	0.40	0.40	0.25	0.25	0.25	0.25	0.45	C2	Table I	<u>LP</u> 5, 7, 3, 4, 2
<u>GLUED-LAMINATED (GLULAM)</u>													
<u>COASTAL WATERS</u>													
Teredo, Limnoria, Pholads Present (See Dual Treatment at end)													
Limnoria Heavy, No Pholads							2.50	2.50	2.50		C28	Table I	MLP
Teredo Present, Limnoria Light							2.50	2.50	2.50		C28	Table I	MLP
(Coastal Douglas-fir, Western Hemlock)	25.0						2.50	2.50	2.50		C28	Table I	MLP
(Southern, Ponderosa, and Red Pines)	25.0	25.0					2.50	2.50	2.50		C28	Table I	MLP
Teredo Present, No Limnoria													
(Coastal Douglas-fir, Western Hemlock)			20.0								C28	Table I	MLP
(Southern, Ponderosa, Red Pines)	20.0	20.0									C28	Table I	MLP

TABLE 5-1--Continued

Wood Products and Usage, Preservative Types and Retentions,
and Applicable Standards*

MATERIAL AND USAGE	Creosote	Creosote - Coal Tar	Creosote - Petroleum	Pentachlorophenol	Pentachlorophenol - With light petroleum or volatile solvent	Acid Copper Chromate (ACC)	Ammoniacal Copper Arsenate (ACA)	Ammoniacal Copper Zinc Arsenate (ACZA)	Chromated Copper Arsenate (CCA)	Chromated Zinc Chloride (CZC)	AMPA Standards C1 and	Federal Specification TT-W-00571J	AMPB STANDARDS
--- Retention by Assay of Treated Wood--lbs./cu.ft. ---													
<u>TIMBERS (cont.)</u>													
<u>GLUED-LAMINATED (GLULAM) (cont.)</u>													
<u>FRESH WATER OR GROUND CONTACT</u>													
(Also for important structural members not in Ground Contact)													
(Southern Pine, Coastal Douglas-fir, and Western Hemlock)	12.0	12.0	12.0	0.60	0.75						C28	Table I	<u>LP</u> 55,77, 33,22
<u>ABOVE GROUND</u>													
(Southern Pine, Coastal Douglas-fir and Western Hemlock)	6.0	6.0	6.0	0.30	0.30						C28	Table I	<u>LP</u> 5,7,3
<u>LAMINATES PRIOR TO GLUING</u>													
<u>GROUND CONTACT</u>													
(Coastal Douglas-fir, Western Hemlock and Southern Pine)	12.0			0.60	0.75	0.50	0.40	0.40	0.40		C28	Table I	<u>LP</u> 55,77, 33,22
<u>ABOVE GROUND</u>													
(Coastal Douglas-fir, Western Hemlock, and Southern Pine)	6.0			0.30	0.30	0.25	0.25	0.25	0.25		C28	Table I	<u>LP</u> 5,7, 3,2
<u>LUMBER</u>													
<u>COASTAL WATERS--WERE:</u>													
Teredo, Limnoria, Pholads Present (See Dual Treatment at end)													
Limnoria Heavy, No Pholads							2.50	2.50	2.50		C2/C18	Table I	MLP
Teredo Present, Limnoria Light							2.50	2.50	2.50		C2/C18	Table I	MLP
(Coastal Douglas-fir, Western Hemlock)	25.0										C2/C18	Table I	MLP
(Southern, Ponderosa, Red Pines)	25.0	25.0									C2/C18	Table I	MLP
Teredo Present, No Limnoria											C2/C18	Table I	MLP
(Coastal Douglas-fir, Western Hemlock)	20.0										C2/C18	Table I	MLP
(Southern, Ponderosa, Red Pines)	20.0	20.0									C2/C18	Table I	MLP

TABLE 5-1--Continued

Wood Products and Usage, Preservative Types and Retentions,
and Applicable Standards*

MATERIAL AND USAGE	Creosote	Creosote - Coal Tar	Creosote - Petroleum	Pentachlorophenol	Pentachlorophenol - With light petroleum or volatile solvent	Acid Copper Chromate (ACC)	Ammoniacal Copper Arsenate (ACA)	Ammoniacal Copper Zinc Arsenate (ACZA)	Chromated Copper Arsenate (CCA)	Chromated Zinc Chloride (CZC)	AWPA Standards C1 and	Federal Specification TT-W-00571J	AWPB STANDARDS
Lumber (cont.)													
--- Retention by Assay of Treated Wood--lbs./cu.ft. ---													
<u>FRESH WATER OR GROUND CONTACT</u>													
(Coastal Douglas-fir, Western Hemlock, Western Larch, Redwood)	10.0		10.0	0.50	0.62	0.50	0.40	0.40	0.40		C2	Table I	LP 55,77, 33,22
(Southern, Ponderosa, Jack, Red, Lodgepole, Northern White, Western White and Sugar Pines)	10.0	10.0	10.0	0.50	0.62	0.50	0.40	0.40	0.40		C2	Table I	LP 44,22
(Interior Douglas-fir)	10.0		10.0	0.50	0.62	0.50	0.40	0.40	0.40		C2	Table I	LP 44,22
(Black or Red Gum)	8.0		8.0	0.40	0.50	0.50	0.40	0.40	0.40		C2	Table I	LP 44,22
(Red Oak)	7.0	7.0	7.0	0.35	0.44	0.50	0.40	0.40	0.40		C2	Table I	LP 44,22
(White Oak)	-- Treat to Refusal --										C2	Table I	LP 44,22
<u>ABOVE GROUND</u>													
(For important structural members use same as for Fresh Water or Ground Contact above)													
Non-structural or Non-Important structural													
(Coastal Douglas-fir, Western Hemlock, Western Larch, Redwood, Southern, Ponderosa, Jack, Red, Lodgepole, White and Sugar Pines, Interior Douglas-fir)	8.0	8.0	8.0	0.40	0.40	0.25	0.25	0.25	0.25	0.45	C2	Table I	LP 5,7,3 4,2
(Red Oak, Black, or Red Gum)	6.0	6.0	6.0	0.30	0.30	0.25	0.25	0.25	0.25	0.45	C2	Table I	LP 5,7,3, 4,2
(White Oak)	-- Treat to Refusal --										C2	Table I	LP 5,7,3, 4,2

TABLE 5-1 --Continued

Wood Products and Usage, Preservative Types and Retentions,
and Applicable Standards*

MATERIAL AND USAGE	Creosote	Creosote - Coal Tar	Creosote - Petroleum	Pentachlorophenol	Pentachlorophenol - With light Petroleum or volatile solvent	Acid Copper Chromate (ACC)	Ammoniacal Copper Arsenate (ACA)	Ammoniacal Copper Zinc Arsenate (ACZA)	Chromated Copper Arsenate (CCA)	Chromated Zinc Chloride (CZC)	AWPA Standards C1 and	Federal Specification TT-W-00571J	AWPB STANDARDS
--- Retention by Assay of Treated Wood--lbs./cu.ft. ---													
<u>PILES</u>													
<u>COASTAL WATERS--WHERE:</u>													
Teredo, Limnoria, Pholads Present (See Dual Treatment at end)													
Limnoria Heavy, No Pholads (Coastal Douglas-fir)						2.50	2.50	2.50		C3	Table II	MP-4	
(Southern Pine--Zone 1)						2.50	2.50	2.50		C3	Table II	MP-4	
(Southern Pine--Zone 2)						1.50	1.50	1.50		C3	Table II	MP-4	
Teredo Present, Limnoria Light (Coastal Douglas-fir)	22.0									C3	Table II	MP-2	
(Southern Pine)	25.0	25.0								C3	Table II	MP-2	
Teredo Present, No Limnoria (Coastal Douglas-fir)	20.0									C3	Table II	MP-2	
(Southern Pine)	20.0	20.0								C3	Table II	MP-2	
<u>LAND OR FRESH WATER</u>													
(Coastal Douglas-fir, Western Hemlock, Lodgepole Pine)	17.0	17.0	17.0	0.85		1.00	1.00	1.00		C3	Table II	LP 55,33 22	
(Southern, Ponderosa, Jack and Red Pines)	12.0	12.0	12.0	0.60		0.80	0.80	0.80		C3	Table II	LP 55,33, 22	
<u>POLES (Round)</u>													
<u>BUILDING</u>													
(Coastal Douglas-fir, Southern, and Ponderosa Pines)	12.0			0.60		0.60	0.60	0.60		C23	Table II	CP(79)	
(Red Pine)	13.5			0.68		0.60	0.60	0.60		C23	Table II	CP(79)	

TABLE 5-1--Continued

Wood Products and Usage, Preservative Types and Retentions,
and Applicable Standards*

MATERIAL AND USAGE	Creosote	Creosote - Coal Tar	Creosote - Petroleum	Pentachlorophenol	Pentachlorophenol - With light petroleum or volatile solvent	Acid Copper Chromate (ACC)	Ammoniacal Copper Arsenate (ACA)	Ammoniacal Copper Zinc Arsenate (ACZA)	Chromated Copper Arsenate (CCA)	Chromated Zinc Chloride (CZC)	AWPA Standards C1 and	Federal Specification TT-W-00571J	AWPB STANDARDS
--- Retention by Assay of Treated Wood--lbs./cu.ft. ---													
<u>POLES</u> (cont.)													
<u>UTILITY</u>													
(When two numbers are shown, use the higher retention for Large Group B poles or in severe service conditions)													
(Coastal Douglas Fir)	9/12			.45/.60	0.75		0.60	0.60	0.60		C4	Table II CP(79)	
(Southern and Ponderosa Pines)	7.5/9			.38/.45	0.56		0.60	0.60	0.60		C4	Table II CP(79)	
(Red Pine)	10.5/13.5			.53/.68	0.85		0.60	0.60	0.60		C4	Table II CP(79)	
(Jack and Lodgepole Pines)	12/16			.60/.80	1.00		0.60	0.60	0.60		C4	Table II CP(79)	
(Interior Douglas-fir, Western Larch, Western Red Cedar)	16.0			0.80	1.00		0.60	0.60	0.60		C4	Table II CP(79)	
(Western Red Cedar, Alaska Yellow and Northern White Cedars)	20.0			1.00							C4	Table II CP(79)	
<u>POSTS</u> (Round)													
<u>BUILDING</u>													
(Coastal Douglas-fir, Southern, Ponderosa and Red Pines)	12.0			0.60			0.60	0.60	0.60		C5	Table II CP(79)	
<u>FENCE</u>													
(Coastal Douglas-fir, Western Hemlock, Western Larch, Southern, Ponderosa, Red, Jack and Lodgepole Pines)	6.0	6.0	7.0	0.30	0.38	0.50	0.40	0.40	0.40		C5	Table II FP	
<u>POSTS</u> (Sawn) See timbers for use in ground contact											C5	Table I	LP 55,77 44,22

TABLE 5-1--Continued

Wood Products and Usage, Preservative Types and Retentions,
and Applicable Standards*

MATERIAL AND USAGE	Creosote	Creosote - Coal Tar	Creosote - Petroleum	Pentachlorophenol	Pentachlorophenol - With light petroleum or volatile solvent	Acid Copper Chromate (ACC)	Ammoniacal Copper Arsenate (ACA)	Ammoniacal Copper Zinc Arsenate (ACZA)	Chromated Copper Arsenate (CCA)	Chromated Zinc Chloride (CZC)	ANPA Standards C1 and	Federal Specification TT-W-00571J	ANPB STANDARDS
--- Retention by Assay of Treated Wood--lbs./cu.ft. ---													
<u>MINE TIMBERS</u>													
<u>Structural</u> (See timbers in ground contact)						Refusal				Refusal C2		Table III	LP 33,44, 22
Other structures													
<u>LUMBER</u>													
In contact or near food. Use 2.5 to 5.0% copper-8-guinlinolate											C2/C29	Table III	None
<u>Lumber</u> --For use above ground--in dry wood termite locations. May be treated with 0.06 lbs./cu.ft. tributyl-tin oxide											C2	Table I	None
<u>DUAL TREATMENTS</u>													
Where teredo, limnoria, and pholads are active, or in southern areas where the borer hazard is uncertain													
<u>PILES</u>													
(Coastal Douglas-fir, Southern Pine)													
First Treatment							1.00	1.00	1.00		C3	Table III	MP-1
Second Treatment	20.0										C3	Table III	MP-1
<u>LUMBER AND TIMBER</u>													
(Coastal Douglas-fir, Southern Pine)													
First Treatment							1.50	1.50	1.50		C2	Table III	MLP
Second Treatment	20.0										C2	Table III	MLP

TABLE 5-1--Continued

Wood Products and Usage, Preservative Types and Retentions,
and Applicable Standards*

MATERIAL AND USAGE	Creosote	Creosote - Coal Tar	Creosote - Petroleum	Pentachlorophenol	Pentachlorophenol - With light petroleum or volatile solvent	Acid Copper Chromate (ACC)	Ammoniacal Copper Arsenate (ACA)	Ammoniacal Copper Zinc Arsenate (ACZA)	Chromated Copper Arsenate (CCA)	Chromated Zinc Chloride (CZC)	AWPA Standards C1 and	Federal Specification TT-W-00571J	AWPB STANDARDS
	--- Retention by Assay of Treated Wood--lbs./cu.ft. ---												
<u>PLYWOOD</u>													
Coastal Waters Building Foundation (Douglas-fir or Southern Pine)	25.0						2.50	2.50	2.50		C9/C27 Table III	MLP	
Fresh Water or Ground Contact	10.0		0.50	0.62			0.60	0.60	0.60		C9/C27 Table III	FDN	FD 55,77,33 44,22
Above Ground	8.0		0.40	0.40			0.25	0.25	0.25	0.45	C9/C27 Table III	FD 5,7,3 4,2	

*Blank space indicates no treatment is available.

The preservative shell of treated wood products must not be broken. Treated materials should not be dragged on the ground, gouged with fork-lifts, or otherwise abused with mechanical equipment. Dropping or dumping can result in breakage, some of which may go undetected. Treated piling may be handled with pointed tools provided that the tools are not used for more than five feet from the end of the piles. For poles, handling tools and loading devices should not be used within one-foot above and two-feet below the specified ground line. Indentations, caused by loading or handling slings, one-quarter inch or more deep over 20 percent or more of the pole circumference render poles unacceptable for use. Other indentations or abrasions should not be more than one-half inch deep at any point. Field fabrication of poles in the ground line area is not permitted and poles cannot be cut off at the butt end after treatment.

When preservative treated wood products are placed in storage, they should be stacked on treated or decay-resistant skids or bunks. The skids or bunks should be constructed so that distortion of the stored products does not result and air is free to circulate under the material.

Storage yards should be well drained and free of debris, decayed or insect infested wood products and vegetation. Green vegetation reduces air circulation and, when dry, presents a fire hazard.

5.5 SAFETY AND ENVIRONMENTAL CONCERNS. The Environmental Protection Agency (EPA) regulates the use and distribution of pesticides including wood preservatives. Safe use of treated wood products, and of preservative solutions used for non pressure treatments is possible using the following practices:

5.5.1 Acceptable Preservatives. Preservatives acceptable for DOD use in the treatment of wood must be approved by the EPA and the Armed Forces Pest Management Board's Committee on wood preservation. The EPA has determined that pentachlorophenol, creosote and inorganic arsenics are, in most cases, restricted use pesticides. A major exception is the nonrestricted, industrial use of inorganic arsenics for application on the cut ends of treated wood products.

Currently, the only restricted use preservatives approved for DOD use are creosote, pentachlorophenol and the water borne salts. General use pesticides are also available.

5.5.2 Consumer Information Sheets. EPA-approved information sheets for each of the three major groups of wood preservatives are being provided by producers to consumers of treated wood products. These sheets, reproduced below, provide users with information about the preservative and about the use and disposal of treated wood products. As a minimal, DOD procurement officials and contractors should become familiar with these information sheets and follow the advice therein.

5.5.2.1 Inorganic Arsenical Pressure-Treated Wood (including: CCA, ACA and ACZA).

CONSUMER INFORMATION

This wood has been preserved by pressure-treatment with an EPA-registered pesticide containing inorganic arsenic to protect it from insect attack and decay. Wood treated with inorganic arsenic should be used only where such protection is important.

Inorganic arsenic penetrates deeply into and remains in the pressure-treated wood for a long time. Exposure to inorganic arsenic may present certain hazards. Therefore, the following precautions should be taken both when handling the treated wood and in determining where to use or dispose of the treatedwood.

USE SITE PRECAUTIONS

Wood pressure-treated with waterborne arsenical preservatives may be used inside residences as long as all sawdust and construction debris are cleaned up and disposed of after construction.

Do not use treated wood under circumstances where the preservative may become a component of food or animal feed. Examples of such sites would be structures or containers for storing silage or food.

Do not use treated wood for cutting-boards or countertops.

Only treated wood that is visibly clean and free of surface residue should be used for patios, decks and walkways.

Do not use treated wood for construction of those portions of beehives which may come into contact with the honey.

Treated wood should not be used where it may come into direct or indirect contact with public drinking water, except for uses involving incidental contact such as docks and bridges.

HANDLING PRECAUTIONS

Dispose of treated wood by ordinary trash collection or burial. Treated wood should not be burned in open fires or in stoves, fireplaces, or residential boilers because toxic chemicals may be produced as part of the smoke and ashes. Treated wood from commercial or industrial use (e.g., construction sites) may be burned only in commercial or industrial incinerators or boilers in accordance with state and Federal regulations. Avoid inhalation of sawdust from treated wood. When sawing and machining treated wood, wear a respirator. Whenever possible, these operations should be performed outdoors to avoid indoor accumulations of airborne sawdust from treated wood. Wear work coveralls rather than street clothes.

When power-sawing and machining, wear goggles to protect eyes from flying particles.

After working with the wood, and before eating, drinking, and use of tobacco products, wash exposed areas thoroughly.

If preservatives or sawdust accumulate on clothes, launder before reuse. Wash work clothes separately from other household clothing.

5.5.2.2 Pentachlorophenol Pressure-Treated Wood.

CONSUMER INFORMATION

This wood has been preserved by pressure-treatment with an EPA-registered pesticide containing pentachlorophenol to protect it from insect attack and decay. Wood treated with pentachlorophenol should be used only where such protection is important.

Pentachlorophenol penetrates deeply into and remains in the pressure-treated wood for a long time. Exposure to pentachlorophenol may present certain hazards. Therefore, the following precautions should be taken both when handling the treated wood and in determining where to use and dispose of the treated wood.

USE SITE PRECAUTIONS

Logs treated with pentachlorophenol should not be used for log homes.

Wood treated with pentachlorophenol should not be used where it will be in frequent or prolonged contact with bare skin (for example, chairs and other outdoor furniture), unless an effective sealer has been applied.

Pentachlorophenol-treated wood should not be used in residential, industrial or commercial interiors except for laminated beams or building components which are in ground contact and are subject to decay or insect infestation and where two coats of an appropriate sealer are applied. Sealers may be applied at the installation site. Urethane, shellac, latex epoxy enamel and varnish are acceptable sealers for pentachlorophenol-treated wood.

Wood treated with pentachlorophenol should not be used in the interiors of farm buildings where there may be direct contact with domestic animals or livestock which may crib (bite) or lick the wood.

In interiors of farm buildings where domestic animals or livestock are unlikely to crib (bite) or lick the wood, pentachlorophenol-treated wood may be used for building components which are in ground contact and are subject to decay or insect infestation and where two coats of an appropriate sealer are applied. Sealers may be applied at the installation site.

Do not use pentachlorophenol-treated wood for farrowing or brooding facilities.

Do not use treated wood under circumstances where the preservative may become a component of food or animal feed. Examples of such sites would be structures or containers for storing silage or food.

Do not use treated wood for cutting-boards or countertops.

Only treated wood that is visibly clean and free of surface residue should be used for patios, decks and walkways.

Do not use treated wood for construction of those portions of beehives which may come into contact with the honey.

Pentachlorophenol treated wood should not be used where it may come into direct or indirect contact with public drinking water, except for uses involving incidental contact such as docks and bridges.

Do not use pentachlorophenol-treated wood where it may come into direct or indirect contact with drinking water for domestic animals or livestock, except for uses involving incidental contact such as docks and bridges.

HANDLING PRECAUTIONS

Dispose of treated wood by ordinary trash collection or burial. Treated wood should not be burned in open fires or in stoves, fireplaces or residential boilers because toxic chemicals may be produced as part of the smoke and ashes. Treated wood from commercial or industrial use (e.g., construction sites) may be burned only in commercial or industrial incinerators or boilers rated at 20 million BTU/hour or greater heat input or its equivalent in accordance with state and Federal regulations.

Avoid inhalation of sawdust from treated wood. When sawing and machining treated wood, wear a respirator. Whenever possible, these operations should be performed outdoors to avoid indoor accumulations of airborne sawdust from treated wood.

Avoid skin contact with pentachlorophenol-treated wood. When handling the treated wood, wear work coveralls with long-sleeved shirts and long pants and use gloves impervious to the chemicals (for example, gloves that are vinyl-coated)

When power-sawing and machining, wear goggles to protect eyes from flying particles.

After working with the wood, and before eating, drinking, and use of tobacco products, wash exposed areas thoroughly.

If oily preservatives or sawdust accumulate on clothes, launder before reuse. Wash work clothes separately from other household clothing.

5.5.2.3 Creosote Pressure-Treated Wood.

CONSUMER INFORMATION

This wood has been preserved by pressure treatment with an EPA-registered pesticide containing creosote to protect it from insect attack and decay. Wood treated with creosote should be used only where such protection is important.

Creosote penetrates deeply into and remains in the pressure-treated wood for a long time. Exposure to creosote may present certain hazards. Therefore, the following precautions should be taken both when handling the treated wood and in determining where to use the treated wood.

USE SITE PRECAUTIONS

Wood treated with creosote should not be used where it will be in frequent or prolonged contact with bare skin (for example, chairs and other outdoor furniture) unless an effective sealer has been applied.

Creosote-treated wood should not be used in residential interiors. Creosote-treated wood in interiors of industrial buildings should be used only for industrial building components which are in ground contact and are subject to decay or insect infestation and wood block flooring. For such uses, two coats of an appropriate sealer must be applied. Sealers may be applied at the installation site.

Wood treated with creosote should not be used in the interiors of farm buildings where there may be direct contact with domestic animals or livestock which may crib (bite) or lick the wood.

In interiors of farm buildings where domestic animals or livestock are unlikely to crib (bite) or lick the wood, creosote-treated wood may be used for building components which are in ground contact and are subject to decay or insect infestation if two coats of an effective sealer are applied. Sealers may be applied at the installation site. Coal tar pitch and coal tar pitch emulsion are effective sealers for creosote-treated wood-block flooring. Urethane, epoxy and shellac are acceptable sealers for all creosote-treated wood.

Do not use creosote-treated wood for farrowing or brooding facilities.

Do not use treated wood under circumstances where the preservative may become a component of food or animal feed. Examples of such use would be structures or containers for storing silage or food.

Do not use treated wood for cutting-boards or countertops.

Only treated wood that is visibly clean and free of surface residues should be used for patios, decks and walkways.

Do not use treated wood for construction of those portions of beehives which may come into contact with the honey.

Creosote-treated wood should not be used where it may come into direct or indirect contact with public drinking water, except for uses involving incidental contact such as docks and bridges.

Do not use creosote-treated wood where it may come into direct or indirect contact with drinking water for domestic animals or livestock, except for uses involving incidental contact such as docks and bridges.

HANDLING PRECAUTIONS

Dispose of treated wood by ordinary trash collection or burial. Treated wood should not be burned in open fires or in stoves, fireplaces or residential boilers, because toxic chemicals may be produced as part of the smoke and ashes. Treated wood from commercial or industrial use (e.g., construction sites) may be burned only in commercial or industrial incinerators or boilers in accordance with state and Federal regulations.

Avoid inhalation of sawdust from treated wood. Wear work coveralls rather than street clothes. When sawing and machining treated wood, wear a respirator. Whenever possible these operations should be performed outdoors to avoid indoor accumulations of airborne sawdust from treated wood.

Avoid skin contact with creosote-treated wood; when handling the treated wood, wear long-sleeved shirts and long pants and use gloves impervious to the chemicals (for example, gloves that are vinyl-coated).

When power-sawing and machining, wear goggles to protect eyes from flying particles.

After working with the wood, and before eating, drinking and use of tobacco products, wash exposed areas thoroughly.

If oily preservative or sawdust accumulate on clothes, launder before reuse. Wash work clothes separately from other household clothing.

5.5.3 Disposal Of Chemicals And Containers. The disposal of containers shall be in accordance with the label instructions.

5.5.4 Preservative Poisoning. All pesticide applicators and supervisors should learn the safety information provided on the Material Safety Data Sheets (MSDS) which lists symptoms and first aid.

5.5.5 First Aid. Basic first aid procedures for poisoning are:

First, remove the individual from further exposure.

Get medical advice quickly if you or any of your fellow workers have unusual or unexplained symptoms starting at work or later the same day. Do not let yourself or anyone else get dangerously sick before calling your physician or going to a hospital. It is better to be too cautious than too late.

First aid is the initial effort to help a victim while medical help is on the way. If you are alone with the victim, make sure the victim is breathing and is not being further exposed to the poison before you telephone/radio for emergency help. Apply mouth-to-mouth resuscitation if the victim is not breathing. Apply Cardio-Pulmonary Resuscitation (CPR) if individual is not breathing and has no pulse.

Read and know the first aid instructions on the MSDS. Follow those instructions. Do not become exposed to poisoning yourself while you are trying to help. Take the pesticide container and MSDS to the physician. Do not carry the pesticide container in the passenger space of a car or truck.

CHAPTER 6. QUALITY MANAGEMENT

The two essential components of a comprehensive quality management program are: (1) procurement specifications that accurately define products which will have an acceptable life expectancy and reasonable cost and (2) adequate inspections to verify compliance with those specifications. Therefore, to ensure quality, team effort is needed between procurement personnel and personnel who receive/inspect materials at points of destination.

Preparation of a procurement document which accurately identifies the type and quality of wood material, the type of wood preservative, and the preservative treatment requirements is the first step in obtaining treated wood products suitable for the intended end use. This is usually accomplished by referencing appropriate consensus standards (Chapter 5) or federal standards (Chapter 5) that address both the required material properties of the wood product prior to treatment and the quality of the preservative and treatment process applied to the wood.

The second step in assuring quality in treated wood products is an independent inspection of materials for conformance of both materials and treatments with the procurement specifications. Materials are inspected for compliance “in the white” within 10 days prior to treatment. Inspections for compliance with treating specifications may be performed at the plant (preferable) and/or at the point of destination.

6.1 PROCUREMENT SPECIFICATIONS. Specifications exist which define the quality of the wood product to be treated, the preservatives to be used, and for the treatment procedure itself. This section will discuss these specifications in detail.

6.1.1 Material Specifications. Material specifications describe the amount of acceptable natural variation in wood properties and identify those natural features (defects) which are not acceptable. Inspection is generally done prior to treatment, i.e., “in the white”.

6.1.1.1 Natural Variability. Since wood is a natural material, material standards, are especially important because the material is characterized by a wide range of variability. However, through a prescribed selection process, wood products with known structural properties and engineering design values are produced.

The engineering design values for wood take into consideration, within limits, the natural strength variations of wood. As described in Chapter 2, the growth rate of wood can affect its strength properties. For example, the American National Standards Institute (ANSI) specifies the minimum number of annual rings which can be accepted in the outer butt portion of poles. The requirement for not less than six annual rings per inch (or four or five rings per inch if 50% or more summerwood is present) helps assure the buyer that poles meeting these material standards should have the strength properties used in the engineering design requirements.

6.1.1.2 Defects. The specifications shall identify unacceptable defects. ANSI, for example, also identifies defects which, for reasons of safety, cannot be accepted: This, too, is seen in standards which disallow all poles with “cross breaks” (see Chapter 2) that could contribute to sudden or early breakage. The American Railroad Association and Railway Tie Association, likewise, define allowable limits for shakes and splits in railroad ties.

A careful materials inspection and selection process eliminates items with natural defects which could contribute to early structural failure of the treated product. For example, certain unacceptable structural defects in utility poles and piles can be visually detected after the bark has been removed and before the pole is preservative treated, but not after treatment because the color of the preservative masks the defects. Thus, inspection “in the white” is critical to the rejection of defective poles or piles which could endanger personnel. The materials inspection process is generally carried out by an independent inspection agency.

6.1.1.3 Specific Products. Wood products must conform to standard specifications that are referenced in procurement documents. These justifications are the basis for product inspection prior to treatment for the following products:

Poles --American National Standard Specifications and Dimensions for Wood Poles, ANSI 05.1 1979. American National Standards Institute, Inc., 1430 Broadway, New York, NY 10018.

Piles --American Society for Testing and Materials, ASTM D25, Standard Specifications for Round Timber Piles. American Society for Testing and Materials, 1916 Race Street, Philadelphia, PA 19103.

Railroad Ties --The Manual of Recommended Practice for Railway Engineering and Maintenance of Right-of-Way, Chapter 3, Ties and Wood Preservation, 1986-87. American Railway Engineering Association, 50F Street, N.W. Suite 7702, Washington, D.C. 20001.

Lumber and Timbers --U.S. Product Standard PS 20-70 for American Softwood Lumber. National Bureau of Standards, U.S. Dept. of Commerce, Gaithersburg, MD 20899.

Structural Use Panels --Performance Standards and Policies for Structural-Use Panels, Sept. 1986. American Plywood Association, Box 11700, Tacoma, WA 98411.

6.1.1.4 Unique DOD Needs. Federal specifications highly recommend inspection of materials prior to treatment, i.e., “in the white.”

As described earlier, many defects can go undetected after treatment due to color changes. In view of the long-term performance expectations of treated materials and the often times costly transportation to distant DOD installations, it is prudent to begin with the selection of a quality product. Furthermore, railroad ties for example are sometimes ordered by species and therefore

accuracy of species identification should be confirmed prior to treatment. For these reasons, inspection of materials prior to treatment should be required in the procurement contract.

This can be accomplished by adding to the procurement contract:

For Utility Poles --Poles shall be inspected “in the white” within 10 days prior to treatment for compliance with ANSI Standard 05.1. Upon inspection, poles shall be hammer branded on the tip end with a brand that identifies both the agency and the inspector (Figure 6-1).

For Piles --All piles shall be inspected “in the white” within 10 days prior to treatment for compliance with ASTM D25. Upon inspection, piles shall be hammer branded on the tip end with a brand that identifies both the agency and the inspector (Figure 6-1).

For Railroad Ties --Within 10 days prior to treatment, railroad ties shall be inspected for compliance with the American Railway Engineering Association specifications for crossties and for confirmation with species requirements of the procurement contract. Upon inspection, ties shall be hammer branded on one end with a band that identifies species in accordance with symbols defined in AWWA Standard M6 and identifies both the inspection agency and the inspector.

For Lumber and Timbers --Lumber and timber shall be inspected in accordance with the appropriate grading rules based on species and shall be marked with a stamp or brand from an agency approved by the American Lumber Standards Committee. When lumber and timbers are used where strength is not a critical factor, the material is not always graded.

For Plywood --Plywood and structural use panels shall be marked with a stamp or brand by an agency in conformance to standards set by the American Plywood Association.

6.1.2 Treatment Specifications. The proper choice and application of preservative for the intended end use is critical to the successful performance of the treated product. Standards require different preservative retentions for different use environments. Substitution of materials properly treated for one environment into another environment may contribute to early structural failure or unacceptable aesthetic qualities. Marine exposures, for example, require heavier retentions of preservatives than are required for use in ground contact. Marine exposures also utilize preservatives such as creosote that are not acceptable for indoor use.

6.1.2.1 Major Components. The American Wood Preservers Association addresses chemical, process, and performance requirements for preservative pressure treated wood products. These standards identify acceptable preservatives and define their chemical composition and that of the related carriers (solvents). The standards also define the amount of each type of preservative and the depth of penetration required by commodity and species of wood. Processing parameters such as temperature are also specified. (For some commodities, such as poles, the preservative penetration and retention within a given assay zone will vary with species). Sampling protocols for inspecting treated wood products and methods for care and handling products after treatment are also addressed.

FIGURE 6-1
Examples of Hammer Marks used on Poles

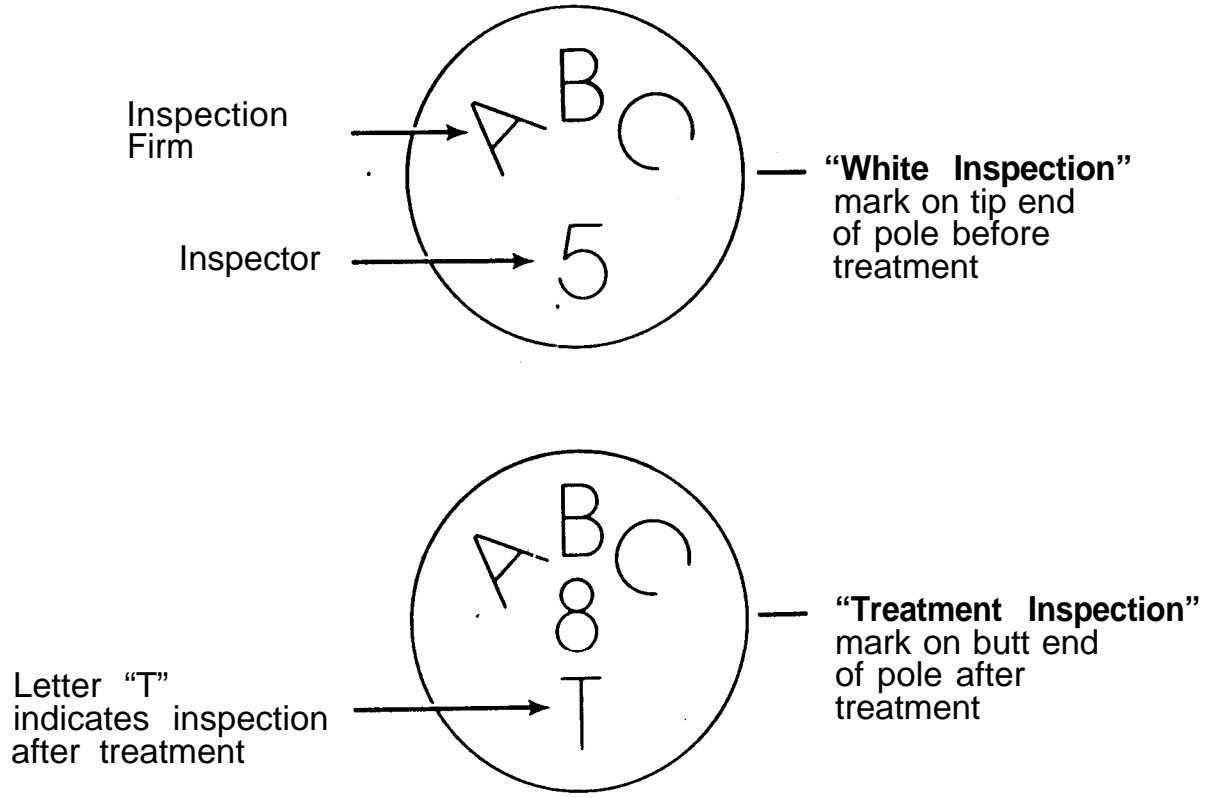

The National Wood Window and Door Association specifies acceptable preservatives and the degree of water repellency required for non pressure treatments.

“Treatment to refusal” is the terminology still used in standards for pressure treatment of a few very difficult to treat woods, such as white oak. When this terminology is used in a procurement specification for pressure-treated products, it does not require a minimum amount of preservative (retention) nor does it require a minimum depth of treatment (penetration). Whenever the minimum retention and penetration are listed in standards for pressure-treated wood products, this terminology, “treatment to refusal,” should not be used. Instead, cite the standard as published. Use of the terminology, “treatment to refusal,” could allow acceptance of poorly treated products that would not otherwise meet standard requirements.

6.1.2.2 Examples of Treatment Specifications. The consensus standards of the American Wood Preservers Association, P.O. Box 849, Stevensville, MD 21666, address pressure treatments and other treatment technologies which contribute to the penetration and retention of the preservative in the wood. The purpose of using AWPA standards is to ensure that wood products are treated with suitable preservatives for reasons of safety, service, and savings resulting from unnecessary, expensive and premature replacements.

The National Wood Window and Door Association Industry Standard for Water-Repellent Preservative Treatment for Millwork I.S.4. covers requirements for water-repellent preservative formulations for wood. For purposes of this standard, millwork includes exterior products such as prefit wood windows, sashes, screens, window frames, blinds, shutters, wood doors (except flush doors), door jambs, cut-to-length trim, and machined knocked-down parts of those products.

The U.S. General Services Administration (GSA) standard for Wood Preservation covers the treatment of different forms and species of wood with various preservatives. Standard requirements are attainable by pressure processes, as well as, by several other processes.

The GSA specification for Wood Preservative: Water-Repellent TT-W-572B covers materials that combine water-repellent and preservative properties of ready-to-use solutions for treatment of wood by simple non-pressure methods.

6.1.2.3 Unique DOD Needs. Sometimes, unique DOD needs require a more precise definition of preservative treatments than is given in standards generally accepted in the industry or federal specifications which are broadly based to encompass the total U.S. wood preservation industry. These needs can most easily be met in procurement specifications by identifying exceptions or additions to existing standards or federal specifications. Attempts to independently write new requirements could easily commit errors by omitting some of the complex considerations of wood species, commodity, and treatment interactions that have been addressed in established standards.

6.1.2.4 Inspection Requirements. To insure compliance by the supplier, with procurement orders, shipments must be inspected. It is U.S. Navy policy to obtain independent in-

specification for verification to avoid conflicts of interest and appearances of such. Therefore procurements of treated wood products exceeding \$1,000 in value, shall include inspection by the government or by an inspection agency independent of the producing company using criteria established in Section 6.1.1.3 and 6.1.1.4.

6.2 INSPECTIONS. Procurement specifications define the level of quality that is required. Inspections are needed to verify that the products being purchased meet the material and treatment standards specified in the procurement order.

6.2.1 Type of Inspections. Inspections may be classified according to location, i. e., at the plant site or at destination, according to whoever employs the inspector, i.e., the producer or the purchaser; or according to the position in the processing schedule. Pre-treatment or “in the white” inspections are made of materials after the bark has been removed, but before treatment. Post-treatment inspections are done after the materials have been treated.

Inspection of products prior to treatment for compliance with material specifications is performed at the plant site. Ties, for example, are inspected for physical characteristics such as size, species, wane, splits, shakes, etc., when they are delivered to the treatment plant and sorted prior to seasoning. Ties which have been air-seasoned are reinspected at the time of boring and branding for seasoning defects such as splits, shakes, decay, warp, etc. Accepted ties are then hammer-branded on one end to signify acceptance by the inspector. Likewise, poles and piling are inspected “in the white” at the treatment plant for compliance with the material specifications and hammer branded on one end to signify acceptance by the inspector.

Whether the treatment plant has complied with processing parameters as specified in the procurement documents can only be determined at the plant. With ties, for example, gauges and charts are examined during and after treatment and a sample of the preservative is taken to verify that the treatment process is being performed in compliance with requirements of the procurement documents.

During inspection at the plant it is also a convenient time for post treatment inspection of large products, such as, piling and poles which require large, specialized equipment for handling. This does not preclude, however, destination inspection of the same treated products.

Although some inspection programs require examination of every piece of treated material, most inspections are performed by sampling. Sampling is utilized primarily to reduce inspection costs. The frequency and intensity of sampling is often defined in treatment standards, but the purchaser has the option of requiring more rigorous sampling. Although commercial wood-treatment companies maintain some form of quality control through internal inspections, additional independent inspections, both at the plant site and at destination, reduce the risk of accepting nonconforming items.

6.2.2 Approved Inspection Agencies. Unless otherwise specified, the supplier is responsible for the performance of all inspection requirements and the government reserves the right to

perform and/or retain services for any of the inspections set forth in the procurement contract.

Tests to verify the accuracy of inspection reports furnished by the supplier shall be all at the expense of the purchaser and made either by the purchaser, or by commercial inspection companies retained by the purchaser. The purchaser may elect to employ the services and accept the brand (Quality Marks) of an independent quality control agency. A list of certified Quality Control Inspection Agencies can be obtained from the cognizant EFD Wood Protection Specialist.

6.2.3 U.S. Navy Policy. It is the policy of the U.S. Navy to obtain independent inspection for verification to avoid conflicts of interests and appearances of such, therefore, wood products purchased by the Navy shall be inspected by the government or by an inspection agency independent of the producer company. The Navy requires that either (1) an independent inspection agency verify that the treated wood products comply with the appropriate AWPA standards or (2) that the treated wood products are stamped by an inspection agency which verifies compliance with the appropriate AWPA standards.

6.2.4 Spot Checking Incoming Shipments. Spot checking of materials being received is one of several important components of a quality assurance-oriented inspection process. The complexity of the procurement system with the involvement of Navy and non-Navy participants creates opportunity for substandard materials to enter into the supply chain. Spot checking of incoming shipments at the point of destination is needed to verify that incoming materials have received an independent inspection, meet the requirement of standards referenced in procurement documents, and are the correct products for their intended use. Specific procedures are spelled out in the NAVFAC Field Guide for the Receipt and Inspection of Treated Wood Products by Installation Personnel.

6.2.4.1 Referral. If there is suspicion that the incoming shipment was not inspected, or does not meet requirements of the procurement specifications, the inspector should reject the shipment. Prior to rejection or acceptance, the inspector may seek assistance from the local Naval Facilities Engineering Field Division Applied Biologist for assistance to make this determination.

6.2.4.2 Evidence of Independent Inspection. All, treated piling, building poles, lumber, timbers and plywood shall have a mark or stamp on each piece and also be accompanied by a copy of the inspection report of an independent inspection agency certifying that the items comply with the appropriate AWPA standards as proof that those items received an independent inspection. For products treated in accordance with AWPA specifications the common symbols for wood species and preservatives will be used on all commodities. These are shown in Table 6-1. Power poles should show the hammer mark (Figure 6-1) of an approved inspection agency in the butt end of each pole as proof of inspection after treatment. Millwork, inspected and approved by the National Wood Window and Door Association, should bear a NWWDA "Quality Certified" brand (Figure 6-2) as proof of inspection. Examples of independent inspection, the quality marks of the American Wood Preservers Bureau and the Southern Pine Inspection Bureau are shown in Figures 6-3 and 6-4 respectively.

TABLE 6-1
Brands Used on Forest Products Treated in Accordance with
Standards of the American Wood Preservers' Association

TYPICAL BRAND AND KEY		PRESERVATIVES	
		<u>Organic Preservatives</u>	
ABCO	Supplier's Brand	B	Copper naphthenate in creosote
D	Plant Designation	C	Creosote
60	Year of Treatment	CM	Creosote for marine use
SPC	Species of Timber and Preservative Treatment	PB	Pentachlorophenol in Volatile Petroleum Solvent (LPG)
---	Retentions	PC	Pentachlorophenol in Light Hydrocarbon Solvent
7-30	Class and Length	PD	Pentachlorophenol in Chlorinated Hydrocarbon Solvent
SPECIES		N	Copper naphthenate in petroleum
AS	Ashes	PA	Pentachlorophenol in petroleum
BE	Beech	TA	80/20 Creosote-Coal Tar Solution
BI	Birches	TB	70/30 Creosote-Coal Tar Solution
BW	Black Walnut	TC	60/40 Creosote-Coal Tar Solution
DF	Douglas Fir	T D	50/50 Creosote-Coal Tar Solution
ED	Northern White (Eastern) Cedar	TM	Creosote-Coal Tar Solution for Marine Use
ES	Engelmann Spruce	XA	80/20 Creosote-Petroleum Solution
GU	Gum	XB	70/30 Creosote-Petroleum Solution
HI	Hickories	XC	60/40 Creosote-Petroleum Solution
JP	Jack Pine	XD	50/50 Creosote-Petroleum Solution
LO	Locust		
LP	Lodgepole Pine		
MA	Maples		
NP	Red Pine		
OA	Oaks		
RW	Redwood		
SP	Southern Pine		
SS	Sitka Spruce		
WC	Western Red Cedar		
WF	Western Firs		
WH	Western Hemlock		
WL	Western Larch (Western Tamarack)		
WP	Ponderosa Pine		
WS	White Spruce		
YC	Alaska Yellow Cedar		

Note: Double treatment, salt and creosote,
letter "C" to be placed ahead of salt symbol.
Where organic preservative is other than
creosote, use the symbol for that preservative
instead of the symbol for creosote.

TABLE 6-1 Continued
Brands Used on Forest Products Treated in Accordance with
Standards of the American Wood Preservers' Association

PRESERVATIVES

Inorganic Preservatives

SA	Acid Copper Chromate (ACC)
SB	Ammoniacal Copper Arsenate (ACA)
SC	Chromated Copper Arsenate (CCA Type A)
SE	Chromated Zinc Chloride (CZC)
SF	Copperized Chromated Zinc Arsenate (CuCZA)
SH	Fluor Chrome Arsenate Phenol, Type A (FCAP-Type A)
SI	Fluor Chrome Arsenate Phenol, Type B (FCAP-Type B)
SJ	Chromated Copper Arsenate (CCA Type B)
SK	Chromated Copper Arsenate (CCA Type C)
SZ	Ammoniacal Copper Zinc Arsenate (ACZA)

QUALITY **NWWDA** **CERTIFIED**
NATIONAL WOOD WINDOW & DOOR ASSOCIATION
WOOD WINDOW UNIT 000 CONFORMS TO NWWDA I.S.-2

QUALITY **NWWDA** **CERTIFIED**
NATIONAL WOOD WINDOW & DOOR ASSOCIATION
WOOD FLUSH DOOR 000 CONFORMS TO NWWDA I.S.-1

QUALITY **NWWDA** **CERTIFIED**
NATIONAL WOOD WINDOW & DOOR ASSOCIATION
WOOD SLIDING PATIO DOOR 000 CONFORMS TO ANSI/NWWDA I.S.-3

QUALITY **NWWDA** **CERTIFIED**
NATIONAL WOOD WINDOW & DOOR ASSOCIATION
WATER-REPELLENT PRESERVATIVE 000 CONFORMS TO NWWDA I.S.-4

ML87 5479

FIGURE 6-2
“Quality Certified” Brand that Indicates Compliance with Standards of the National Wood Window and Door Association



M_cC
→

THE AWPB QUALITY MARKS

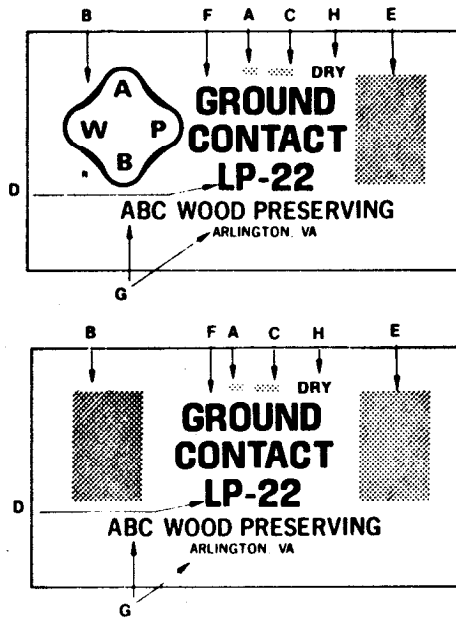

- A Year of treatment
- B American Wood Preservers Bureau trademark or trademark of the AWPB certified agency
- C The preservative used for treatment
- D The applicable American Wood Preservers Bureau quality standard
- E Trademark of the AWPB certified agency
- F Proper exposure conditions
- G Treating company and plant location
- H Dry or KDAT if applicable

Jason

CMR

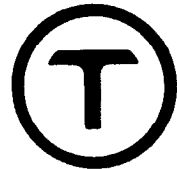

FLIS

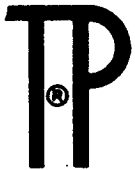

SW
LAB

FIGURE 6-3

Rendition of Quality Mark used by the
American Wood Preservers Bureau and Stamps of
AWPB-Certified Inspection Agencies

6.2.4.3 Certificates. Reports or certificates of conformance (CoC) shall accompany all shipments of piling, building poles, power poles, lumber, timbers, and plywood produced under lot inspection procedures. Reports or CoC's shall show actual test results for penetration and retention of preservative, as well as, conformance to other requirements of a standard, such as, KDAT (Kiln Dried After Treatment) when required.

6.2.5 Inspection Methods. Spot inspections should be conducted in a two-step sequence of checks for compliance with material standards, followed by checking for compliance with treatment specifications. Generally, one should look for brands, marks or stamps that evidence inspection of the commodity prior to treatment (in the white) and that verify independent inspection after treatment. Since brands are sometimes difficult to locate on railroad ties, increment borings may be made to inspect the level of treatment. Specific procedures for spot checking poles, piling, railroad ties, lumber, timber, and plywood are given below.

There are two types of poles; round building poles and power poles.

To check for evidence of inspection prior to treatment, look on the tip (top) end of the poles for a brand that identifies the inspection agency and the inspector (Figure 6-1). Upon inspection "in the white", poles which meet material standards are hammer stamped on the tip end. This is the only stamp that is ever put on the tip end.

To determine the type of treatment and preservative retention level, check the brand applied by the supplier. Following preservative treatment, poles are branded on the face side of the pole 10 feet from the extreme butt for poles 50 feet or shorter and 14 feet from the extreme butt for poles over 50 feet long. These brands contain the following information:

- (1) Supplier's Name
- (2) Plant Designation
- (3) Year of Treatment
- (4) Species of Timber and Preservative Treatment.
- (5) Preservative Retention
- (6) Class and Length

The symbols used for preservatives and wood species are shown in Table 6-1.

Power poles are treated in accordance with the appropriate federal standard or AWWA Standard C4 and are inspected under Power Pole Standard REA DT-5C. To determine that power poles have been inspected, check for a hammer mark of an approved inspector/agency on the butt end of each pole (See Figure 6-1). The brand must contain the letters WQC or equivalent quality mark.

Building poles shall be treated in accordance with AWWA standard C23. In shipments for which the American Wood Preservers' Bureau was responsible for independent inspections, look for the AWPB Quality Mark as evidence that building poles were inspected. The notation "CFP" either tagged or branded verifies treatment and inspection to AWPB Standards. In shipments for which the Southern Pine Inspection Bureau was responsible for independent inspections, look for the SPIB Quality Mark and the notation "CCP" for Construction Poles and Posts (Figure 6-4). For other Quality Marks contact the cognizant EFD Wood Protection Specialist.

There are three types of piles: marine, general, and foundation. Marine piles are exposed to sea water; general piles are used in fresh water or in soil, but not capped with concrete; and foundation piles are entirely embedded in the ground and capped with concrete.

To determine if piling was inspected prior to treatment, check for the inspector's hammer brand on the tip end of the piling, just as with poles.

To determine the type of preservative that was used and the retention to which the piling was treated, check the brand applied by the supplier. Each pile is branded at points 5 feet and 10 feet from the butt end of the pile. These brands show:

- (1) Supplier's Brand
- (2) Plant Designation
- (3) Year of Treatment
- (4) Species of Timber and Preservative Treatment
- (5) Retention(s)
- (6) Length

The symbols used for preservatives and wood species are shown in Table 6-1.

The standards for treatment of piles are addressed in AWWA commodity Standards C3 and C18.

For those piles procured with the services of the inspection program offered by the American Wood Preservers Bureau, check the piles for the AWPB monel tag (Figure 6-5) to verify inspection. To determine the intended use of piling inspected with the AWPB program, read the letter symbols for the respective AWPB Inspection Standard:

Letters	Intended Use
FLFW	Foundation, land, or fresh water
MP 1	Marine piling or camel logs - dual treatment with waterborne preservative and creosote
MP 2	Marine piling or camel logs - treated with creosote for marine waters
MP 4	Marine piling or camel logs-treated with waterborne preservatives for marine waters.

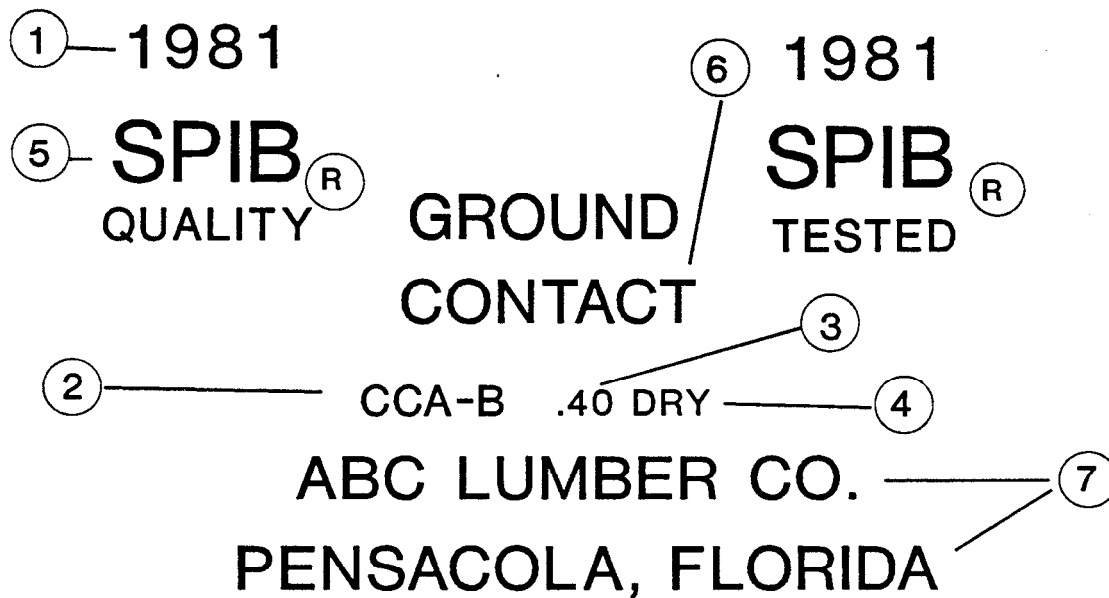

KEY:

- (1) YEAR OF TREATMENT
- (2) PRESERVATIVE SYMBOL
- (3) PRESERVATIVE RETENTION SYMBOL
- (4) LETTERS DRY AND/OR T50 AS APPLICABLE
- (5) SPIB CERTIFICATION MARK
- (6) INTENDED USE OF MATERIAL
- (7) IDENTITY OF TREATING COMPANY
AND PLANT LOCATION

FIGURE 6-4

Quality Marks Used by the Southern Pine Inspection Bureau

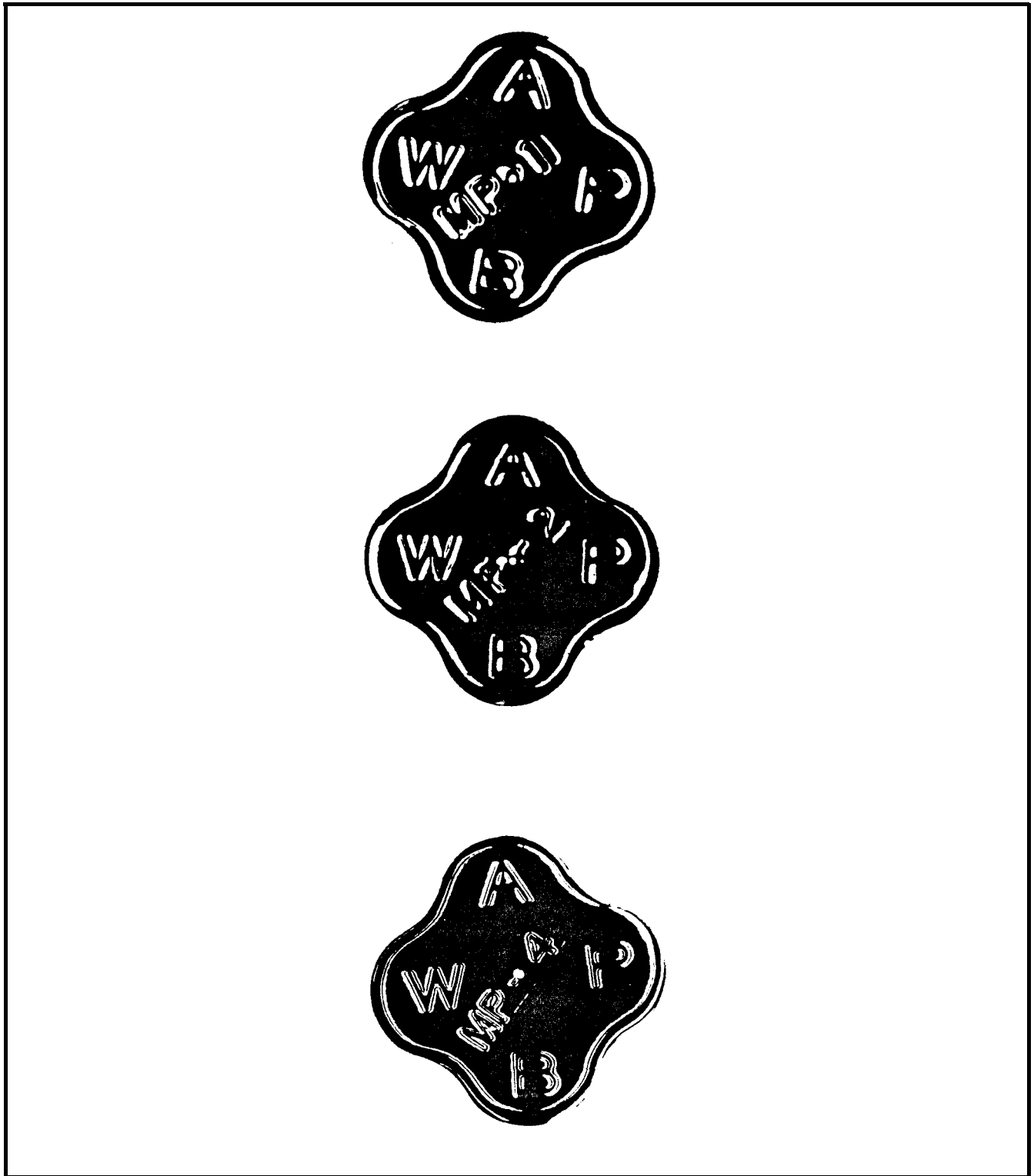

FIGURE 6-5
Replica of Monel Tags used on Marine Piling by
AWPB-Certified Inspection Agencies

For piles inspected by the Southern Pine Inspection Bureau, look for the SPIB Certification Mark beneath the typical product brand (Figure 6-6). To determine the intended use of the SPIB-inspected piling, read the letter symbols in the SPIB Quality Mark that denotes use:

Letters	Intended Use
FP	Foundation, land, or fresh water
SW	Marine piling or camel logs --treated with either creosote or with CCA
SWD	Marine piling or camel logs --dual treated with creosote and with CCA
MARINE PILES FOR SALTWATER USE, DUAL TREATMENT (SWD)	
Typical Product Mark	
ABCO-	Producer Name and location
87 -	Year of treatment
SP -	Species
30 -	Length, if applicable
<hr/> SPIB _R SWD- SPIB Certification mark and piling use mark	
XXXX	SPIB Assigned Plant Number
MARINE PILES FOR SALTWATER USE (SW)	
Typical Product Mark	
ABCO-	Producer Name and location
87 -	Year of treatment
SPC -	Species and preservative type
12 -	Preservative retention
30 -	Length, if applicable
<hr/> SPIB _R SW SPIB Certification Mark and piling use mark	
XXXX	SPIB Assigned Plant Number

FIGURE 6-6
SPIB Code Used on Marine Piling and Camels

Piling and poles at the destination site are generally stacked so that brands, marks, tags, or quality marks on sides or faces of piling or poles are visible or partially visible on about 35% of the piling or poles in the top rows. The standard requires all piles to be marked but if a sufficient number of brands, marks, tags or quality marks are visible, it can be reasonably assumed that all other pieces are so marked.

Ties. The pertinent standard for treatment of ties is AWWA Standard C-6. Following treatment; increment borings are extracted from a representative sample of ties, inspected for preservative penetration and analyzed for preservative retention. The ends of the ties are also examined for evidence of damage during treatment, such as, splits, shake, or honeycomb. Ties accepted by the inspector are hammer-branded on the opposite end of the tie to which the acceptance mark was applied before treatment.

The hammer stamps will be similar to those used for poles (Figure 6-1). Typically the stamps will identify the inspection agency and inspector. They may assume any geometry, i.e., round, square, etc. Usually the hammer mark applied after treatment will also contain a "T" within it.

Therefore, if the procurement documents require that ties be marked with a hammer before, after or both before and after treatment, spot checking can be accomplished by looking for hammer marks on the ends. The hammer marks may not be clearly legible on every tie, but they should be evident on at least some ties. Where this type of hammer-marking is not required, increment borings will have to be made to determine whether the preservative penetration is adequate. If preservative penetration appears to be inadequate, a request for additional inspections should be made to the cognizant Applied Biologist.

Lumber, Timbers and Plywood. Spot checking of these commodities can be done by looking for the stamp or mark on each item which verifies independent inspection. The NAVFAC Field Guide for the Receipt and Inspection of Treated Wood Products by Installation Personnel provides specific details.

Lumber has three classifications according to size. These are as follows:

- (1) Boards which are less than 2 inches in nominal thickness and are 1 inch or more in width.
- (2) Dimension lumber which is from 2 inch nominal thickness up to, but not including, 5 inches nominal thickness, and is 2 inches or more in nominal width. Dimension lumber may also be called or classified as framing, joists, planks, rafters, studs, etc.
- (3) Timbers are 5 inches or more nominal in their least dimension. Timbers are also called beams, stringers, posts, girders, etc.

Plywood is a flat panel, comprised of layers (veneers) of wood with the wood grain in adjacent layers usually running at right angles, glued together.

As mentioned previously, each piece of pressure treated lumber, timber, or plywood shall bear a mark or stamp that will be evidence of an independent inspection of the wood after it was preservative treated. Thus, to spot check incoming treated wood that was procured under approved inspection programs, one should locate the Quality Marks and read the included information to determine what preservative was used and for what end-use application the material is intended. When checking materials that have been inspected under the program of the American Wood Preservers' Bureau, it is important to recognize that the Bureau has a number of "Inspection Standards" for lumber, timber and plywood. The lettering and numbering used to identify each of these standards provides information on both the preservative used and the intended use environment for the treated wood. By carefully reading these marks (Figure 6-3) the person receiving the shipment can determine whether the materials received are appropriate for the planned use. These inspection marks or stamps are:

- LP-2 Pressure treated with water-borne preservatives for above ground use.
- LP-22 Pressure treated with water-borne preservatives for ground contact use.
- LP-3 Pressure treated with light hydrocarbon solvent-penta solution for above ground use.
- LP-33 Pressure treated with light hydrocarbon solvent-penta solution for ground contact use.
- LP-4 Pressure treated with volatile hydrocarbon solvent (LPG) penta solution for above ground use.
- LP-44 Pressure treated with volatile hydrocarbon solvent (LPG) penta solution for ground contact use.
- LP-5 Pressure treated with creosote or creosote-coal tar solutions for above ground use.
- LP-55 Pressure treated with creosote or creosote-coal tar solutions for ground contact use.
- LP-7 Pressure treated with heavy hydrocarbon solvent-penta solution for above ground contact use.
- LP-77 Pressure treated with heavy hydrocarbon solvent-penta solution for ground contact use.

FDN Permanent wood foundation

MLP Pressure treated for marine exposure

The appropriate identifying label is included within the AWPB mark on each piece of treated wood. Thus to spot check incoming treated wood using the AWPB inspection program, locate the quality marks and read the included information to determine what preservative was used and the intended end-use of the material.

The SPIB Quality Mark on lumber and plywood, also connotes information on the preservative used, that minimum preservative retention is met or exceeded, whether it was or was not redried before inspection after treatment and intended end use (See Figure 6-4). The SPIB Quality Mark is used on treated forest products when those products conform to the pressure treating requirements of the American Wood Preservatives Association Standards as they relate to waterborne treatments. The SPIB Quality Marks give the following information about preservatives and end use:

Designation	Description
CCA-A	Chromated Copper Arsenate - Type A
CCA-B	Chromated Copper Arsenate - Type B
CCA-C	Chromated Copper Arsenate - Type C
DRY	Seasoned in accordance with the contract specification. If drying is specified without stating the moisture content, it shall be construed to mean a maximum of 19% moisture content in lumber and 18% in plywood.
TSO	Treater has provided treating service only, i.e., no drying.
Ground Contact Use	Intended for use in contact with ground.
Above Ground Use	Intended for use where material does not come in contact with ground and is not in marine environment.
Foundation	For use in wood foundations.

CHAPTER 7. PREVENTIVE MAINTENANCE AND REMEDIAL CONTROL

This chapter will discuss inspection and in-place remedial treatment procedures for poles, piles, timber and other heavy wood members, as well as crossties. These maintenance activities can substantially extend the service life of the treated wood products. Inspection protocols are addressed in American Wood Preservers' Association Standards M2, Standard for Inspection of Treated Timber Products. AWPAs requirements for the care of preservative treated poles, piles, lumber and ties are given in Standard M4, Standard for the Care of Preservative-Treated Wood Products.

7.1 POLES. Types of deterioration problems, inspection procedures and remedial treatments for poles will be discussed in this section. Because of the complexity of pole inspection and maintenance, it is strongly recommended that installations contract with reputable commercial pole maintenance firms for the following services.

7.1.1 Problems To Be Found.

7.1.1.1 Decay. This section will address inspection and remedial treatments for decay and insects in standing poles.

Internal Decay. Internal decay occurs as a result of fungus infestations that start in poles before treatment (while air drying on yards) and where wood destroying organisms are able to penetrate the outer protective shell of preservative treated wood (Figure 5-1) surrounding sterile, but unprotected wood. Deep checks which develop after treatment, mechanical damage from improper handling, woodpecker holes or other actions which break the protective shell, provide avenues for entry of decay fungi. Due to the constant presence of moisture, internal decay is most common at the ground line. Internal decay will also develop in pole tops cut or bored in the field when supplementary treatment is neglected. Do not cut the butt ends off poles when they are set in the ground. This exposes a central core of untreated wood at the bottom of the pole and provides easy access to termites and decay fungi.

With southern pine poles, poor preservative penetration is an important contribution to internal decay. Sapwood that has not been adequately penetrated with the proper amount of preservatives readily decomposes. Well treated southern pine poles, that are predominately sapwood, are not prone to suffer from serious internal decay (Figure 7-1). Douglas-fir poles are often air dried for several years prior to treatment. Decay fungi become established in the poles during that time. If the poles are not sterilized during preservative treatment, the fungi will continue to grow or rot the center of the pole after it has been put in place. As with other species, checks and mechanical damage in the shell of treated wood also expose the center of the pole to decay fungi.

External Surface Decay. External decay is most common at or below the ground line (Figure 7-2). Each occurrence of external decay below the ground line reflects improper application of the preservative or use of treating solutions with poor preservative properties.



FIGURE 7-1

In this Well-Treated Southern Pine Pole, only a Small Area in the Center was left Untreated and Subject to Decay



FIGURE 7-2
External or Surface Decay is Most Common at the Ground Line

As poles age, external decay may develop as the effectiveness of the treatment begins to decline.

External decay in the above ground sapwood zone frequently occurs in red cedar poles in which only the butts have been treated. This type of decay is called shell rot.

7.1.1.2 Insects. Attacks of the untreated interior portions of poles by subterranean termites or carpenter ants are difficult to detect. However, if insects can gain entry, so can decay fungi. Therefore, the two will often occur together.

7.1.2 Inspection Procedures. The purpose of pole inspection is to: (a) identify poles which are dangerous and should be replaced, (b) identify poles which are in the early stages of deterioration so that corrective action can be taken, and (c) establish/maintain the installation's pole plant records.

7.1.2.1 Visual. A visual examination of the poles, using binoculars to inspect tops, can provide valuable information regarding the pole's condition.

Decay. Machined, damaged areas, and checks should be critically examined during visual inspections. The size and location of seasoning checks should be noted. In general, the wider the check, the deeper it penetrates and the more likely untreated heartwood is exposed. Remember, only decay in the advanced stages is readily apparent. The presence of fungi in wood where decay has not progressed appreciably can be detected only by culturing or microscopic examination of the wood. Incipient decay can extend four feet or more above internal rotten areas in Douglas-fir poles.

Surface decay usually occurs at or below the ground line, so digging is generally necessary to detect it. It can also occur above ground in the sapwood of untreated cedar poles.

Termites and Carpenter Ants. These insects infest the internal untreated portion of poles. Therefore, little external visual evidence of their presence is apparent. Some termite galleries may be present if the insects are trying to bridge over treated wood. In addition, if a carpenter ant infestation has occurred, scattered bits of very fibrous and sawdust-like frass may be present in the area. Since a break in the protective shell must occur before these insects can reach and infest the untreated wood, decay is also likely to be present.

Vertebrate Organisms. Damage from vertebrate organisms, such as woodpeckers, is usually apparent. Binoculars should be used when inspecting large poles. If the damage is fresh, broken pieces of wood from the excavated hole should be present on the ground. Decay will be associated with older damage (Figure 7-3).

Mechanical. Mechanical damage is generally obvious and found in the ground line area to a few feet above the ground.

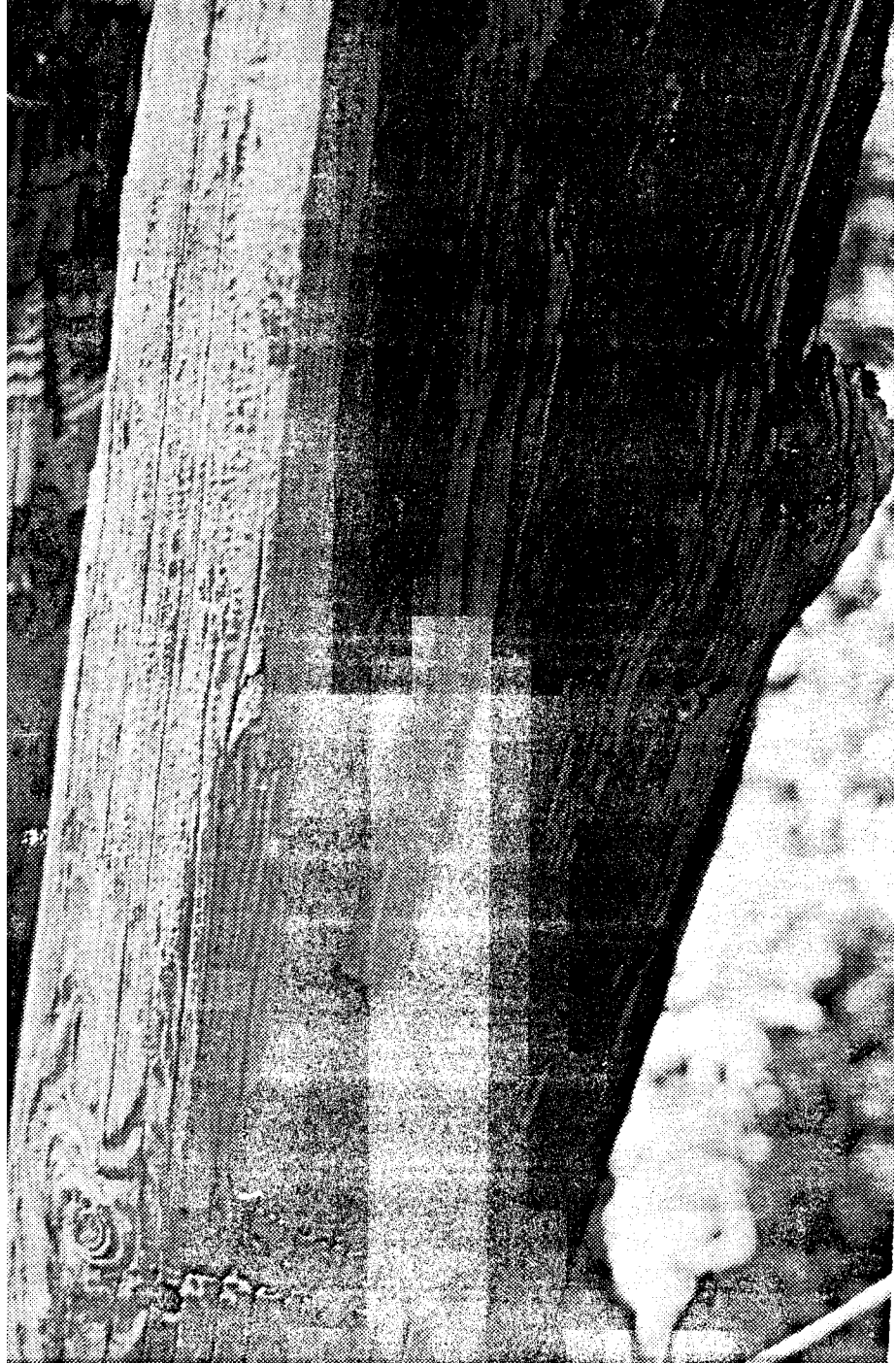

FIGURE 7-3
Serious Internal Decay has Occurred in this Pole Because Fungi
Gained Access from the Woodpecker Damage and a Small Bore Hole (left)

7.1.2.2 Physical Tests. In addition to visual inspections, several physical tests are available to aid pole inspectors in determining the presence of biological damage. Some of these methods are very basic while others involve sophisticated electronic equipment. Nondestructive testing equipment is currently being developed to provide estimates of residual strength in poles. In all cases, considerable experience is required to interpret the results, especially with the newest non-destructive testing devices for wood poles.

Sounding. Sounding is probably the most common method of inspecting poles for internal voids. The pole is firmly hit with about a one-pound hammer from ground level to as high as one can reach. A crisp sound usually indicates the pole is solid. A dull thud indicates wet and possibly rotten wood and a “drum” sound indicates a void. The sound produced varies considerably, but experience will eventually lead to distinguishing between sound wood and the various defects. Sounding usually detects only the worst poles. Naturally, to develop experience, it helps to sound a pole and then bore or cut it apart to determine which defects are actually present.

Boring. Where decay or insect attack is suspected, the pole is generally bored for confirmation (Figure 7-4). Increment bores are most commonly used. The core can be closely examined at the site and also saved for later culturing or microscopic examination. An effective, but simple way to save increment cores is to insert them into soda “straws”, seal the ends and label for identification. Protected in this manner, increment cores can be shipped to a laboratory for biological studies.

Poles that sound suspicious should be bored near deep checks which occur, at or one foot below the ground line. If rot is detected, the poles should be bored at three or four points around the circumference. The shell thickness, depth of preservative treatment, and pole circumference are determined. Minimum circumference tables can be used to determine if the pole should be replaced, reinforced, field treated or scheduled for reinspection.

When boring holes above ground, the tool should be oriented slightly upward. This prevents water from accumulating in the hole. At ground line, a 45 degree angle downward is generally used. All openings made during inspection should be treated with the appropriate preservative as registered by the EPA. The holes should be plugged with preservative treated dowels. These dowels can loosen and work out of the holes so treatment of the hole itself is important. Protective goggles and other safety equipment as appropriate should be worn as preservative can squirt out of the hole as the dowel is being driven or as the hammer strikes the treated wood.

In lieu of taking increment cores, poles are sometimes drilled, preferably with a bell-hanger’s bit which produces a quantity of shavings. Decay is “detected” by the operator on the basis of change in resistance of the wood to the bit, and by odor of the decayed wood. No other confirmation of decay is attempted.

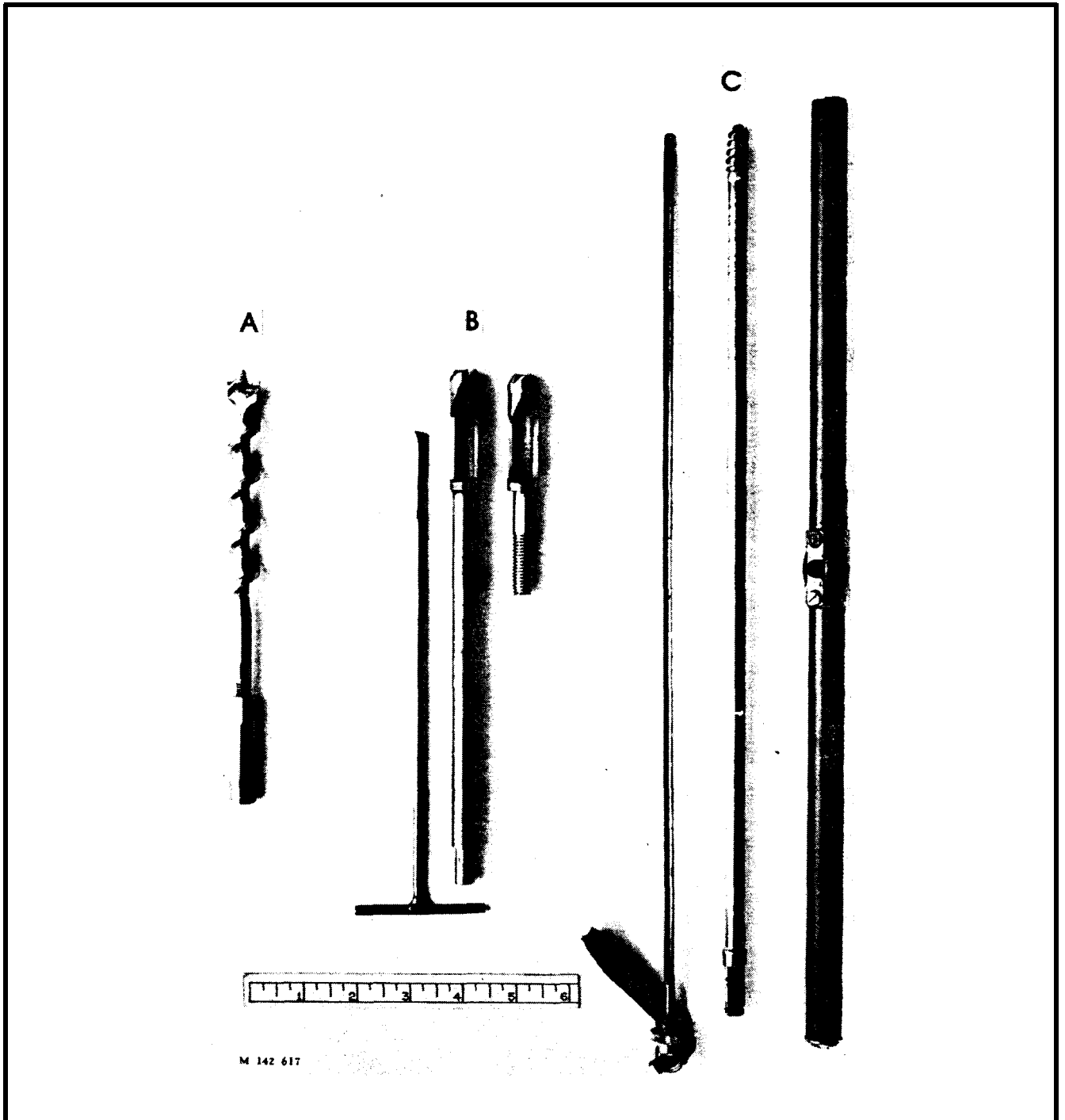

FIGURE 7-4
Boring and Coring Tools: A, Auger-Type Bit used for
Extracting Bored Shaving Samples; B, Plug Cutter and Plug Extractor;
C, Increment Borer Consisting of Three Parts--
Extractor, Hollow Bit, and Case that also Serves as a
Handle for Turning Coring Bit into and out of Wood Members

Scraping and Pick Devices. The depth of surface decay can be detected by the pick test. The pick test (see Chapter 4) will detect infected wood where strength loss of at least 10% has occurred. Scraping using a shovel or triangular blade is often used to detect below g-round decay on the pole surface. The decayed wood is simply scraped or cut away until sound wood is evident.

Moisture Meter. Resistant type meters (Figure 7-5) can detect the moisture content of wood to a depth of about 2 1/2 inches. Because the high moisture content of decaying wood--above 25 percent--causes a steeper than normal moisture gradient, the meter can be useful for determining the extent of decay in poles and other timbers. Meter readings above 20 percent and steep moisture gradients indicate the height of decaying wood in Douglas-fir poles with rot below, but not above the ground line. Moisture readings below 20 percent indicate the absence of active decay to the depth of the electrode.

The batteries and calibration of the meter should be checked frequently. For the meter to read from the tips of the electrodes, the coating on the electrode shanks must be intact. When necessary, meter adjustments for ambient temperatures and wood species must be made. Oil borne preservatives normally do not affect meter readings, but inorganic salts may. Comparative tests for treated and untreated wood should be conducted to determine the effect of preservatives.

Shigometer. The shigometer measures the pulsed electrical resistance of wood and was developed for detecting decay in trees. To conduct the test, a 3/32 inch diameter hole is bored into the wood. The probe, which consists of two twisted, insulated wires with the insulation removed from the tip, is inserted to various depths in the hole. A marked change in electrical resistance indicates rot or a defect. The moisture content must be at the fiber saturation point (about 28 percent) or higher for the shigometer to work. Decaying wood or that in ground contact is at the fiber saturation point or higher.

Attempts to apply this technology to the detection of decay in utility poles have revealed that many factors, in addition to decay, influence the electrical resistance of wood. This has contributed to some confusion in the use of this methodology. Therefore, when the device indicates decay in poles, the poles should also be bored to verify the presence and extent of decay.

Pilodyn. The pilodyn is an instrument that drives a spring-loaded pin into wood and indicates the depth of penetration. The instrument has been used to measure tree density, sorting wood and detecting surface decay and soft rot in poles. It can generally characterize the outer two inches of a pole or that zone which accounts for 70 to 90 percent of the load-carrying capacity. The pilodyn can be used in combination with a density determination to predict breaking strength of ponderosa pine poles. Pilodyn measurements must be corrected for moisture content since moisture affects wood strength and because it varies substantially in outdoor wood structures. For quantitative measurements and maximum benefit, the instrument should be calibrated for species, moisture content, and the amount and type of preservative. Pilodyn readings on Douglas-fir can be adjusted for moisture content by using a resistance moisture meter.

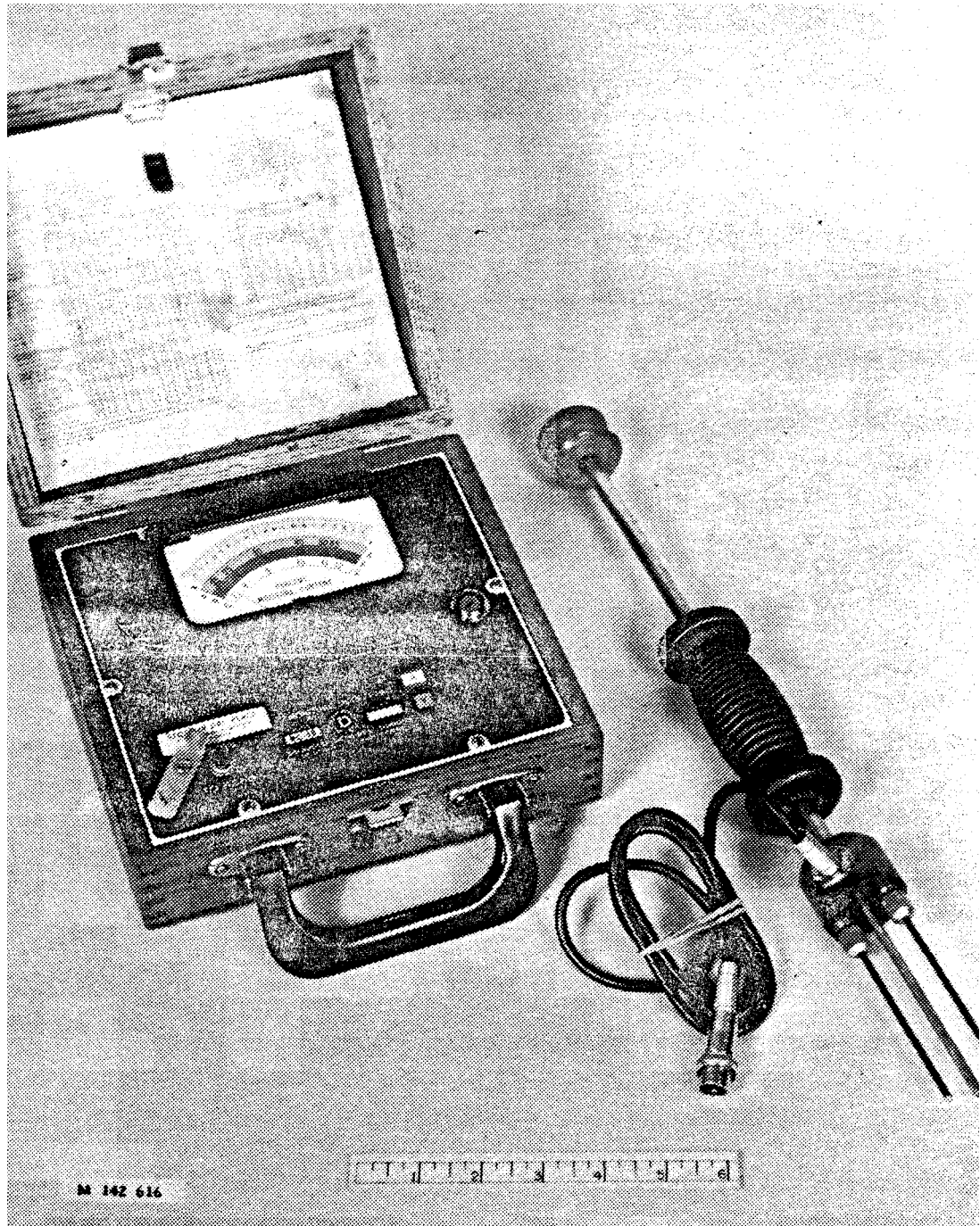

FIGURE 7-5
Moisture Meter Suitable for Inspection Work

Pol-tek. The pol-tek is a sonic testing device that does not require boring. Starting about six inches below the ground line, probes are pressed on opposite sides of the pole. A trigger trips a hammer that sends a sound wave down one probe, through the pole, and up the other probe where it is recorded. Rot or low density areas will delay the sound wave and result in a lower reading than with a sound pole of the same diameter. The reading is nearly instantaneous. Boring is done to determine the extent of decay in those poles with low readings. It is reported that the pol-tek works well on Douglas-fir and Western red cedar, but not as well on southern pine because of the high incident of ring shake.

New Technologies. Even newer technologies are being developed to nondestructively estimate residual strength in standing poles. More field experience is required before comment can be made on the practical utility of those devices in the field.

Shell Thickness Indicator. A shell thickness indicator (Figure 7-6) is used to determine the thickness of the remaining wood. The rod is inserted into the hole made by coring or drilling and then pulled back with pressure against the side of the hole. The hook at the end will catch on the remaining sound wood. When pushing a tight fitting shell-thickness indicator into a hole, you can feel the tip of the hook pass from one growth ring to another in solid wood, but not in rotten wood. Marks may be inscribed on the side to indicate shell thickness at drilling angles of 45 and 90 degrees.

7.1.2.3 Biological Tests. It is important that the presence of decay fungi be detected and treated as early as possible, if the strength properties of the wood are to be maintained. Biological tests are still the most reliable means for detecting early stages of decay.

Culturing. The early or “invisible” stages of decay can be detected by culturing in the laboratory. Culturing is done by collecting cores in the field. Each core is placed in a plastic straw, labeled and the ends of the straw stapled shut. The cores are brought to the laboratory and culturing begins within 24 hours. If additional time is required before culturing, the cores should be stored in a refrigerator or transported in chilled containers.

Once the cores arrive at the laboratory, the surface is sterilized and the core is embedded in a sterile nutrient media. Care must be exercised to avoid contamination. The media and core are incubated for three to four weeks at 70 to 81 degrees Fahrenheit. The cores are observed frequently for fungal growth. Microscopic examinations are made at the end of three to four weeks to determine if the fungi are capable of causing decay. Culturing and the recognition of decay fungi require special equipment and trained personnel.

Insect Collection. It is usually beneficial to identify insects if an infestation has occurred. If field identification is not possible, either collect the insects, their frass or a portion of the wood with typical damage, and consult the cognizant PMC for assistance with positive identification.

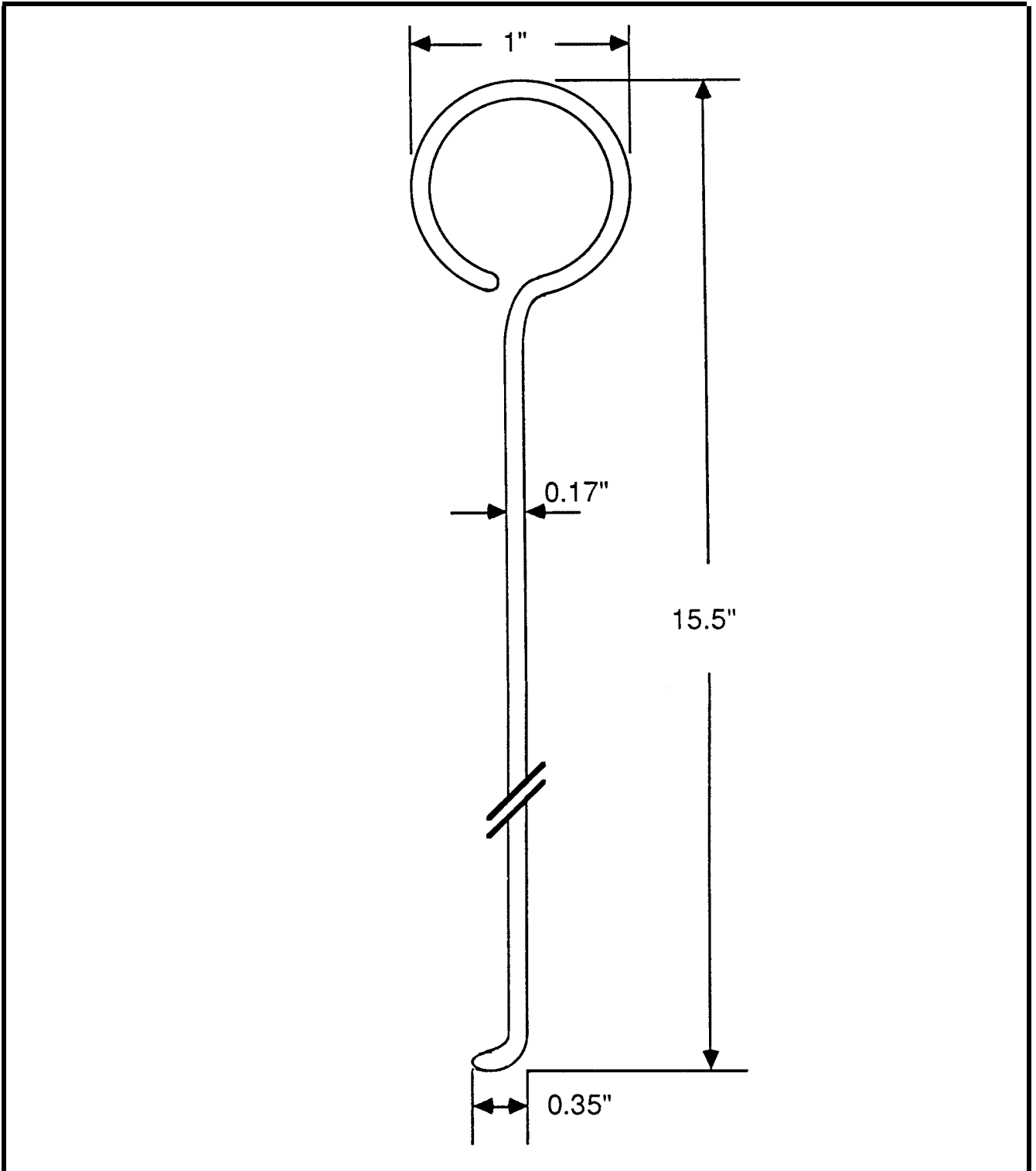

FIGURE 7-6
A Shell Thickness Indicator is used to Determine
the Thickness of the Remaining Shell

7.1.3 Determination Of Serviceability. As the integrity of a wood member is destroyed by biological agents, its ability to withstand the load it was designed for is diminished. As more and more wood is destroyed, the structure becomes weaker. With poles, the location of the wood that is destroyed is perhaps more important than the amount of wood destroyed. The outer 44% of the pole radius contributes most (about 80%) of the bending strength. Therefore, decay in the core of the pole will reduce strength substantially less than if the outer shell is destroyed.

The National Electrical Safety Code specifies the allowable stress for poles when installed and at replacement for different grades of construction. Depending on the amount and location of wood lost, it can be determined if the pole still meets the safety code requirements. Poles which do not meet or exceed minimum requirements are generally marked for replacement. Others can be field treated to arrest the wood destroying organisms.

7.1.4 Remedial Treatment. Major power companies and cooperatives of the USDA-Rural Electrification Administration have determined it is more cost effective to apply remedial treatments to poles, that show signs of biological (decay or insect) damage but are still capable of carrying the required loads, than to replace them. A number of different treatments are available through the commercial firms who inspect and treat poles. **NAVFAC Specification TS-20312** provides criteria for contract writers. The cognizant PMC can provide further assistance and a list of reputable pole maintenance firms.

7.1.4.1 Ground Line or Bandage Treatment. These treatments have long been used to control surface decay in the outer shell of poles. Preservatives used include water soluble arsenicals and fluorides, alone or mixed with creosote, pentachlorophenol or dinitrophenol and potassium bichromate. Other materials may be used depending on the formulator. The formulation is either a liquid or a paste. These preservatives diffuse into the wet wood. They can be brushed on or injected 2-1/2 inches into the wood with a hollow needle. Thoroughly brushing on a thick coat of preservative assures that the surface is well treated and that all crevices are filled. The outer wrap, often black polyethylene film with a paper back, should be durable and extend from slightly above to 18 inches or more below the ground line. The layers are overlapped and the wrap is fastened tightly to the pole in order to shed water. Some preservatives are incorporated in the wrap. The wrap should not be damaged as the backfill is being replaced.

Before treatment, the surface to be treated should be cleaned of any decayed or loose wood. No more sound wood than necessary should be removed. All debris should be removed from the excavated area around the pole.

NAVFAC TS-20312 specifies the following for ground line treatment:

GROUND LINE TREATMENT: A preservative material approved in paragraph 7.0, Section 00004, shall be thoroughly and evenly applied, at the maximum allowable thickness specified on

the pesticide's label, with a stiff bristle brush, to all poles marked for ground line treatment and steel stub reinforcement. All checks and pockets will be thoroughly treated. Preservative shall be applied to sound wood from 4 inches above to 18 inches or more below ground level. All external decay and loose wood shall first be removed from the treatment zone with a sharp chipping tool. All chips and decayed pieces shall be removed from the hole. Care shall be exercised to remove the least possible amount of sound wood. Prior to backfilling, a polyethylene-coated kraft paper shall be tightly wrapped and securely stapled around the treated portion of the pole.

7.1.4.2 Internal Void Treatment, Liquid preservatives or fumigants may be used to control decay and/or insect attack within the central core of poles.

Liquid Preservatives. Internal void treatment with liquids is most successful on cedar and other woods that develop well defined rot pockets and where the transition from rotten to sound wood is abrupt; they are least effective in Douglas-fir with poorly defined rot pockets. For Douglas-fir, the use of a fumigant alone or in combination with a water-soluble solution should be used. To arrest internal decay, water-soluble chemicals or arsenicals and fluorides are forced into the voids and diffuse through the wet wood. Ants in pole voids can be controlled by injection with volatile liquids combined with creosote or pentachlorophenol.

NAVFAC TS-20312 specifies the following for internal void treatment:

INTERNAL VOID TREATMENT: Serviceable poles with voids, hollows or insect galleries shall be internally treated with a liquid pesticide registered by the EPA for such use. Poles shall be bored with a 3/8 inch drill bit, a sufficient number of times to assure uniform internal coverage. Preservative shall be pumped into the bottom hole until it runs out the next higher hole. The hole is then plugged with a preservative-treated plug, and preservative shall be pumped into the next higher hole until it runs out the hole above. The procedure is repeated until the entire cavity is flooded or a maximum of one gallon of preservative is used.

Fumigation. (Note: Because of the extreme hazards associated with fumigants, they shall only be applied by individuals who hold a valid DOD or State Pesticide Applicator Certification in the Category applicable to fumigation. Consult the cognizant PMC for local regulations concerning fumigation). Fumigants can control internal decay for at least nine years in pressure treated Douglas-fir transmission poles. As a result, the use of fumigants to treat Douglas-fir poles, piles and timbers with internal decay is common technology. However, fumigation treatments aren't as long-lasting in southern pine poles and timbers as they are in Douglas-fir.

Sodium N-methyl dithiocarbamate (Vapam), methylisothiocyanate (Vorlex), and trichloronitromethane (chloropicrin) are currently registered with the U.S. Environmental Protection Agency (EPA) for application to wood.

Label directions for applications of individual fumigants must be followed. In general, starting at the ground line, a 5/8 to 7/8 inch diameter hole is drilled directly towards the center of the pole at a steep downward angle. The hole should not be through the pole or intersect seasoning checks which would allow the fumigant to escape. Additional holes to obtain good distribution of the fumigant are equally spaced (and drilled in a downward direction) around the pole in an upward spiral pattern with a vertical spacing of 6 to 12 inches. If more than two treating holes intersect an internal void or rot pocket, redrill the holes further up the pole into relatively solid wood where the fumigant will gradually volatilize and move through the wood. The fumigant placed in rot pockets will be lost if the seasoning checks connect the pocket to the outside of the pole. If the rot pocket is above the ground line, holes should be bored above and below the pocket. A three inch long treated plug is inserted into each hole.

Fumigant applicators must wear protective clothing and should stand upwind. The proper amount of the chemical is slowly squeezed into the lowest hole first, leaving enough space for the plug. A tight fitting preservative treated plug is driven into the hole. Care must be exercised not to squirt fumigant from the hole. The applicator continues to work up the pole one hole at a time.

Decay fungi reinvade vapam treated poles in about five years, but the fungal population remains low for at least nine years. These poles should be retreated every nine years by placing additional fumigant in the same hole. Because poles treated with chloropicrin and with Vorlex have remained virtually free of decay fungi for 8 years, retreatment may be delayed ten or more years.

The effectiveness of wood fumigants for long term insect control is uncertain. Vapam may control subterranean termites, however, carpenter ants are known to reinfest wood shortly after fumigant application, perhaps because of the decreased fumigant concentration.

NAVFAC TS-20312 provides the following instructions for pole fumigation:

FUMIGATION: Serviceable poles which cannot be properly excavated around the entire circumference for causes beyond the contractor's control such as concrete, macadam, tree roots, etc., or found to contain internal voids caused by decay and insects shall be fumigated in lieu of typical digging/preservative treatment upon concurrence of the QAE. All such poles will be sounded with a hammer in accordance with paragraph 3.1, Section 00005. Excavated poles will be further sounded in accordance with paragraph 3.3, Section 00005.

Three quarter inch diameter holes shall be drilled at 45° angles or steeper into the pole. Each hole shall be at least 15 inches deep. The first and last holes shall be drilled one foot beyond incipient decay or voids. The drilling pattern shall have holes spiraled around the pole approximately 90 degrees from the previous hole, and 6-12 inches above the nearest lower hole. An EPA registered pole fumigant containing 32.7 percent Vapam (sodium N-methyl dithiocarbamate) shall be poured into all holes at the rate specified on the label. Void treatment of poles

which are excavated shall be performed in addition to normal ground line preservative treatment. All holes shall be sealed with preservative-treated wooden dowels or equivalent. Distinctive durable, weatherproof tags shall be affixed to fumigant treated poles.

7.1.4.3 Reinforcement or Stubbing. Reinforcing or stubbing a pole is usually done when the ground line area of the pole has been destroyed to the point where it is no longer safe, but the upper portion can still support existing or expected maximum loads. Poles which require considerable transfer work are often stubbed. Wood stubs have been used in the past but metal stubs (Figure 7-7) are currently specified in **NAVFAC TS-20312**. The reinforcement system must also comply with the National Electric Safety Code. The pole must also be treated to ensure that any active decay is stopped.

7.2 PILES. A pile is “a timber, usually round, that is embedded wholly or partly in surface soil or under water soil as a support for a superstructure such as a bridge, building, trestle, wharf, etc.” Three types of piles are used. Foundation piles are entirely embedded in the ground and are capped with masonry. They are generally used to support a structure in unstable soil. General piles are used in fresh water or in soil and are partly embedded or are not capped with concrete. Marine piles are partially embedded in bottom soil and partly exposed to salt sea water and are generally subject to attack by marine organisms.

Those portions of piles exposed above ground line to the atmosphere or fresh water are subject to the same problems as poles and much of the discussion on poles is applicable. However, pilings are subject to additional problems.

7.2.1 Problems To Be Found.

7.2.1.1 Decay. After a pile is driven, the tops are usually cut off. This practice exposes the untreated wood in the core to decay (Figure 7-8). Sometimes the cut is made at a steep angle which exposes more surface area and further increases the decay potential.

7.2.1.2 Marine Borers. When pilings are installed in salt or brackish water, they are often subjected to marine borer attack. Limnoria often attack piling at the intertidal zone, whereas, shipworms attack it below the tidal zone.

7.2.2 Inspection Procedures. NAVFAC manuals **MO-104, Maintenance of Waterfront Facilities**, and **MO-104.2, Specialized Underwater Waterfront Facilities Inspection**, provide excellent technical guidance for maintaining a good inspection and repair program. The inspection procedures for decay as discussed under poles apply to piling. However, care must be exercised if the wood is kept excessively wet, due to contact with water or where salt has been absorbed. The presence of salt will affect the readings obtained from the shigometer, electric moisture meter or other devices which depend on the electric characteristics of wood.



FIGURE 7-7

A Metal Stub was used to Reinforce this Pole
Before it was Removed from Service

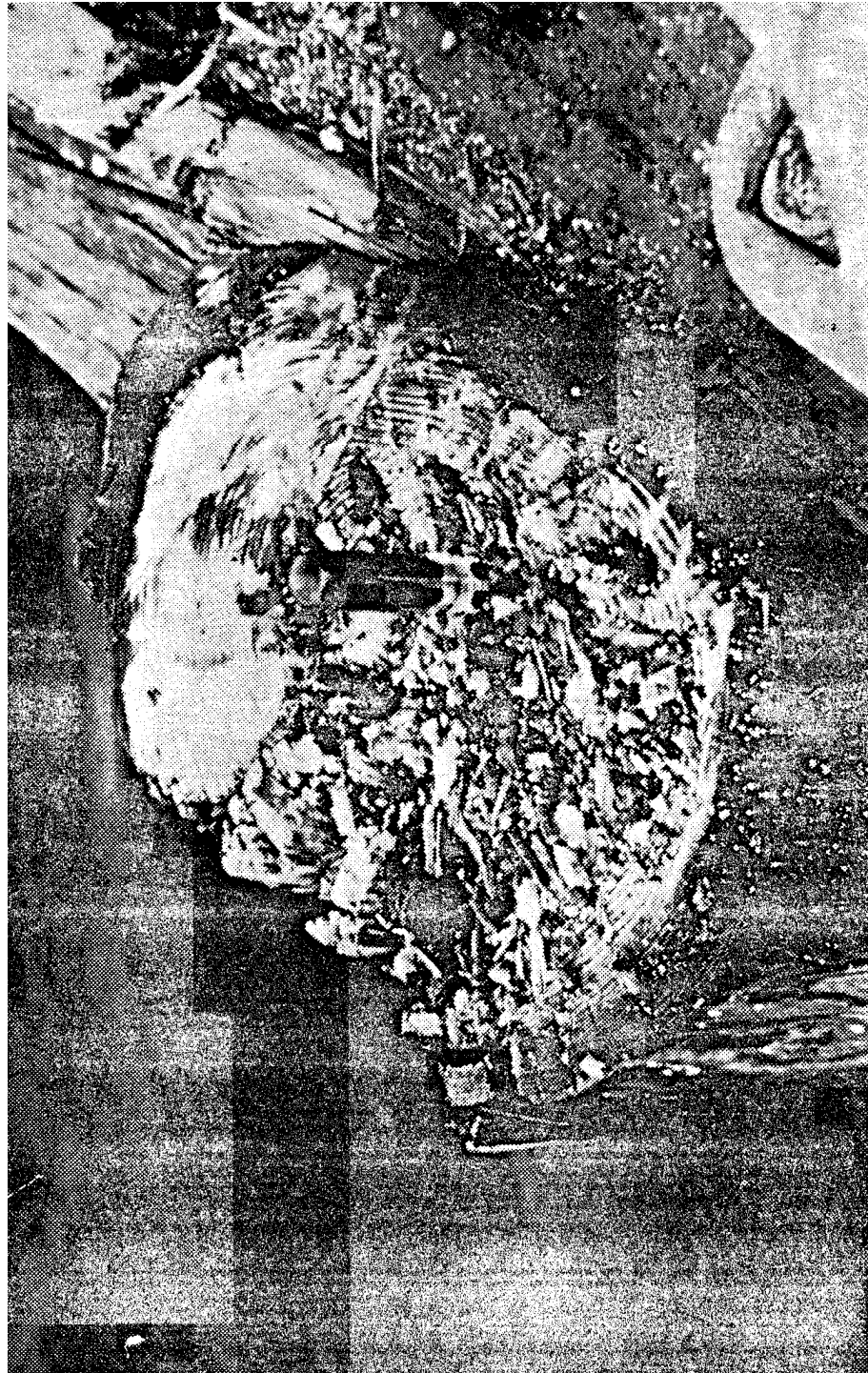

FIGURE 7-8
Because the End of this Pile was Cut Off after Driving,
Untreated Wood was Exposed and Decay Resulted

7.2.2.1 Marine Borers. It is more difficult to inspect for marine borers due to the presence of water. In some cases, borers are present in a salt water wedge located under incoming fresh water.

Limnoria can generally be detected during periods of low tide. As discussed in Chapter 4, *Limnoria* concentrate their attack on the external surface of piling, usually in the tidal zone (Figure 4-30). They may be more prevalent on the shaded side of structures. Therefore, inspectors normally take advantage of low tides and simply wade out to check piling in shallow water and use small boats or floats in deeper water.

Damage signs include the hourglass shape of piles in the tidal zone, numerous tiny bore holes in the wood and a general softening in the attacked areas. Holes made by hooks and tongs become oval-shaped as attack progresses, ends of bracing are hollowed out, and bolts and bracing are loosened.

Limnoria attack wood inside of holes, cracks, or gouges. Therefore, a flashlight or head lamp is useful. A scraper or probe is used to remove fouling organisms and to check inside holes and between adjoining members, etc.

7.2.2.2 Shipworms. Shipworms are much more difficult to detect since they bore small holes into the surface of the wood and concentrate their attack beneath the surface (Figure 4-32). The tiny entrance holes are difficult to detect. Observant divers in clear water may be able to see the nearly transparent siphons or the tiny pallets protruding from the pile surface, if the shipworms are alive. The extent of internal damage cannot be assessed visually.

Sounding of piling by divers can provide some information about the degree and location of borer damage. However, the procedure is highly subjective.

Increment coring can also be used. However, with poor underwater visibility, fouling, etc., it is difficult to determine where to bore, and the odds of hitting a destroyed area are reduced, due to the size of the bore. The bore holes must be plugged to prevent further damage.

7.2.2.3 Sacrificial Test Blocks. The potential damage from marine borers can be assessed by immersing “sacrificial” untreated wood samples at the site in question. The simplest way to do this is to band or nail (use galvanized nails) lengths of untreated 2x4’s, posts or similarly sized wood pieces to vertical posts or piling already installed in the area of interest (Figure 7-9). These samples are removed at one month intervals and examined for damage. For shipworms, the blocks must be split open to accurately detect attack. Where freshwater flow is present, the blocks must be submerged and held in the salt water wedge located under the freshwater.

7.2.2.4 Sonic Testing. A sonic testing method which will locate and quantitatively assess marine borer and other internal damage for in-place timber piles has been developed. The system operates on the premise that the velocity and strength of sound waves passing through wood vary inversely with any voids in the wood. The signal is correlated to the degree of damage and the amount of undamaged wood remaining in the pile cross-section. In actual practice,

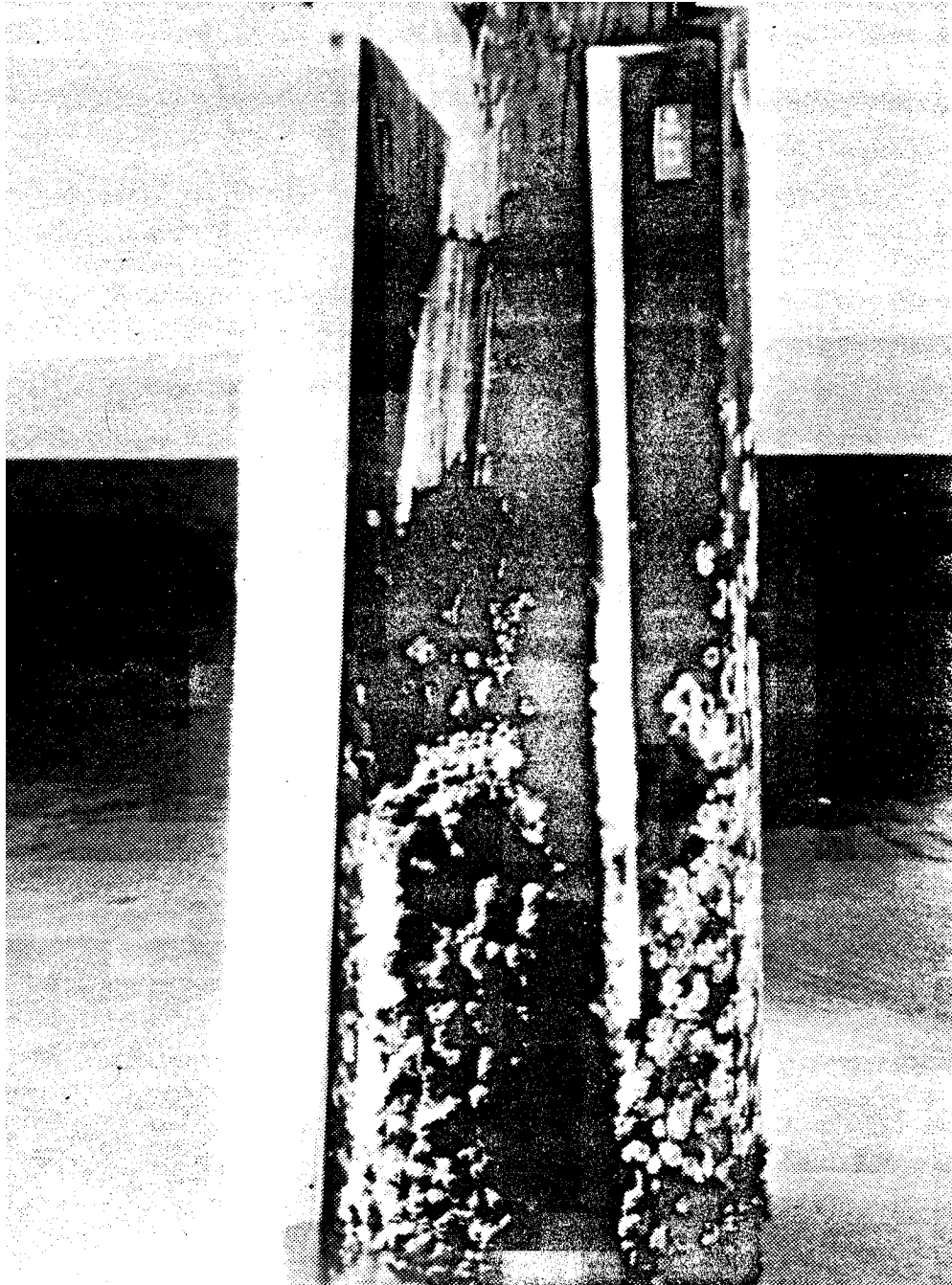

FIGURE 7-9

Untreated and Lightly Treated 2x4's Fastened
to an Existing Marine Piling Provide a Simple Means for
Determining which Marine Organisms are Present

transducers operating at about 30 KHZ are attached to a rack or frame at a fixed distance, one above the other. This assemblage (“sonic probe”) is manipulated by a scuba diver to provide a scan of the pile from the surface of the water to the mud line. A surface technician, who is in telephone contact with the diver, collects and records the data. The data is then computer analyzed to determine current load carrying capacity of the piles. Under average conditions, one two-man crew can test approximately 100 piles per day.

7.2.3 Remedial Treatments.

7.2.3.1 Determining Serviceability. The effect of the loss of wood on pile strength is similar to that for poles. The sonic testing method is one way in which the remaining strength of a pile can be assessed. The decision on whether the pile should be left or replaced is best left to an engineer familiar with wood design and expected loads. In those cases where the pile is decayed or infested with marine organisms, but it is still capable of bearing the expected loads, remedial in-place treatment is necessary.

7.2.3.2 Decay Prevention. The procedures discussed for the ground line treatment, void treatment and fumigation of poles can also be applied where appropriate to piles.

Since pile tops are commonly “cut-off” after driving and top decay results, remedial treatment is required. This cut-off area should be treated with a preservative and then capped as described in Chapter 5. These treating recommendations require flooding the exposed surface with hot creosote (150 to 200 degrees fahrenheit), pentachlorophenol in diesel oil, or copper naphthenate. A water-shedding cap is then applied. None of these preservatives penetrate the wood deeply.

Materials used for capping piles include coal tar-roofing cement, galvanized metal, copper sheathing, heavy roofing felt, heavy plastic, Noah’s pitch, hot asphalt, and preservative-treated plywood. One effective capping device is coal tar-roofing cement held in place by a fiberglass mesh cloth. To cap a pile by this method, trowel a thick layer (1/2 inch) of cement on top, place two layers of fiberglass mesh on the cement, nail the mesh to the pile, and finish with an additional coat of cement. This patch remains flexible and resists water penetration into the untreated wood below.

Galvanized metal, roofing felts and plastic sheets make effective caps when applied in conjunction with chemical treatments. Without a preservative, condensation or leaks can create ideal conditions for decay beneath the cap. The material should be cut with at least a 2-inch overlap to permit the edges to be folded down and fastened to the pile sides with galvanized roofing nails or bands.

Noah’s pitch or hot asphalt may be applied to pile tops before addition of a water-shedding cap. However, these materials only penetrate the wood to a shallow depth and are of little use if the cap leaks.

Preservative-treated plywood makes a simple but effective capping device. Two narrow strips of treated wood are nailed to the pile top, and the plywood cap, cut to a slightly larger diameter than

the pile, is attached to the strips. The strips permit air to circulate beneath the cap and, thus, keep the wood dry.

Because pile caps on working piers are often damaged or pulled off by hawsers, it is helpful to treat the top with a water-soluble preservative before cap installation. These treatments remain inactive as long as the cap remains effective, but they are activated whenever water penetrates.

7.2.3.3 Borer Damage. When an engineering determination is made to repair rather than replace borer damaged piles, several options for repairing and preventing additional damage are available. **NAVFAC MO-104** provides a number of repair techniques for fender and bearing piles. Repair may involve partial replacement of damaged wood with treated wood and reinforcing weakened areas. Prevention of damage is accomplished by encasing the pile in an impermeable barrier.

7.2.3.4 Barriers. Impermeable barriers are used to protect the wood below the water line. These barriers prohibit the entry of new borers into the wood and kill the established borers by limiting the available oxygen supply. The barriers must cover a zone from below the mud line to above the high tide line and completely encase the piling. They may provide protection from marine borers for 25 years or more and are advisable when inspection reveals a 15 to 20 percent loss of cross sectional area from marine borer attack. Numerous materials have been used, but 30 to 60 mil polyvinylchloride or polyethylene wraps and two inch thick concrete are probably the most common. Polyvinylchloride was used initially, but more recently two-layer polyethylene sheets have been used. A 20 mil sheet is heat shrunk before the piling is driven. To protect against abrasion, a 150-mil polyethylene sheet is attached at the intertidal zone or to fender piles with aluminum alloy nails. However, corrosion will occur if these nails are used on wood treated with copper-chromium-arsenic (CCA) or ammonical copper-arsenic (ACA) preservative. Protected piles should be inspected periodically for damage to the barrier. Procedures for installing plastic barriers are given in **NAVFAC TSM-B10**, Installation of Flexible Plastic Barriers on Marine Borer Damaged Wood Piles.

7.3 TIMBERS AND OTHER HEAVY WOOD MEMBERS. Timbers are those members five or more nominal inches in their least dimension. They are also called beams, stringers, posts or girders. Inspection procedures and control techniques for timbers and other heavy wood members are similar to those for poles and piling as already discussed. Additional information unique to the product is provided below.

7.3.1 Problems To Be Found.

7.3.1.1 Nature of Timbers. Timbers are different than poles or piles in that they are sawed products. With the exception of Southern pine, they usually do not contain a continuous sapwood band which is easily treated. Therefore, incising of most large timbers will improve the preservative treatment. In addition, many timbers will contain a pith center which results

in a deep radial seasoning check from the surface to the center. This check often penetrates past the treated zone.

7.3.1.2 Construction Techniques. Heavy timber construction often requires substantial shaping, boring and dapping at the erection site. This machining breaks the protective shell. The shell can also be broken by nailing which often occurs in timber construction. Exposing the machined areas to wood destroying organisms will only hasten interior deterioration of the wood. Figure 7-10 shows the likely locations where decay and infestation might occur. Every effort should be made to prevent or limit exposure of machined sections to marine borers, insects, or decay fungi.

7.3.2 Inspection Procedures.

7.3.2.1 Visual. The visual inspection of heavy timbers is similar to that for other wood products. External evidence of decay includes features such as fruiting bodies, abnormal surface shrinkage, such as, localized depressions or sunken faces on wood surfaces, loose joints, abnormal deflections, crushing, cracking, etc., and insect activity. Remember, carpenter ants and termites prefer damp wood.





Other visual evidence such as water marks from periodic wetting, rust stains, especially if from wood-penetrating fasteners or hardware, and plant growth such as moss or other vegetation, especially in cracks or crevices, indicates that existing conditions are, or have been, conducive to decay.

7.3.2.2 Detecting Decay. Decay in heavy timbers is detected in much the same way as previously described for wood poles. The “pick test” or probing can be used to detect surface decay. Sounding by an experienced inspector can provide some estimate of the potential for internal decay. Boring or coring is used to estimate the extent of internal decay. Moisture meters may be used to determine if the wood is moist enough to support decay.

7.3.3 Remedial Treatments. Remedial treatments may be either external or internal.

External treatments include the elimination of the moisture source, and/or flooding the surface or critical areas with an acceptable preservative. Pentachlorophenol has traditionally been used for treating wood surfaces. The value of new preservative emulsions may have some use in that they can concentrate larger quantities of toxic preservatives in a localized area.

For interior treatment of timbers, pressure injection of one of the water borne preservatives is appropriate. Application of liquid preservatives without pressure can also be effective, but penetration is primarily along the grain of the wood. The fumigants, vapam and chloropicrin have been shown to be effective in controlling decay in horizontal members, particularly in Douglas-fir.

-  INCIPIENT DECAY
-  INTERMEDIATE DECAY
-  ADVANCED DECAY
-  TREATED WOOD

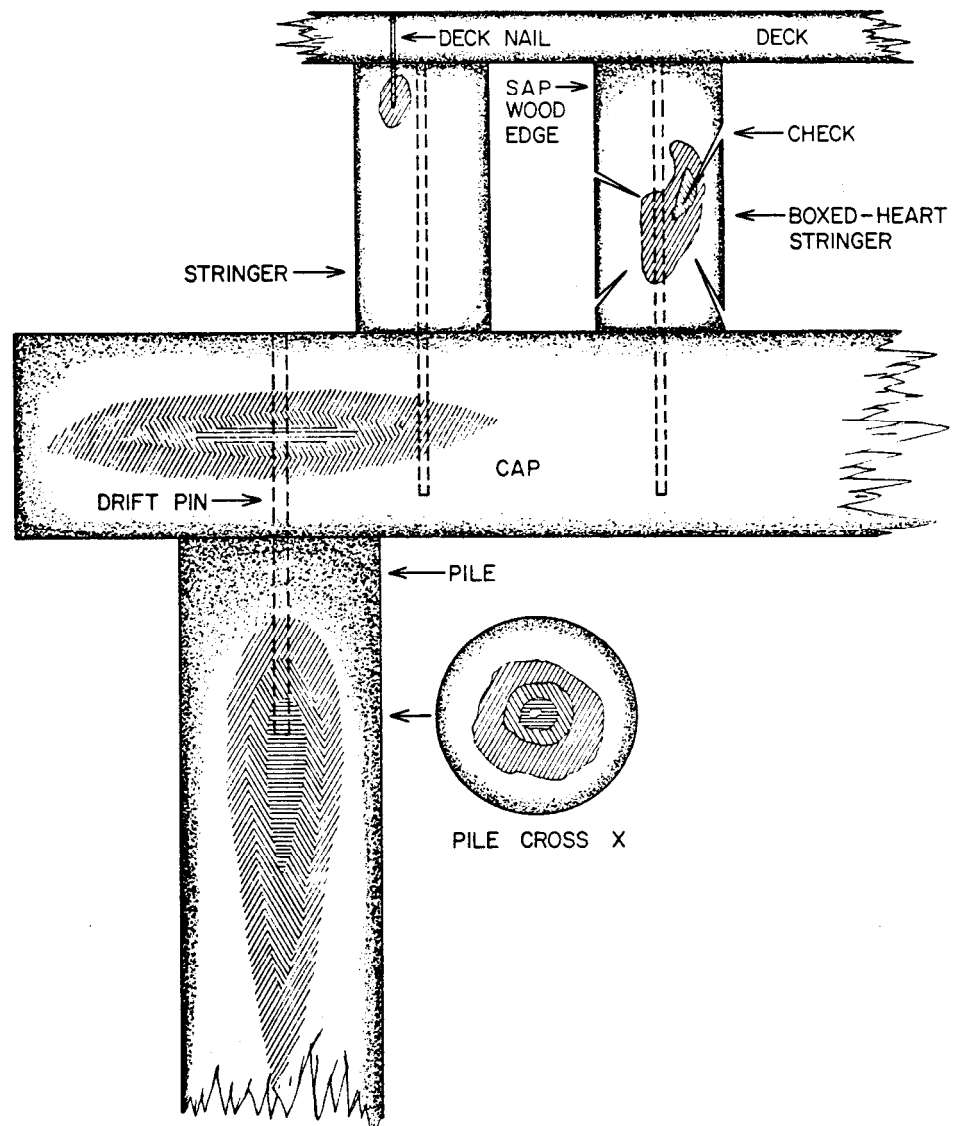

FIGURE 7-10
 Schematic Drawing of Typical Wood Bridge Construction
 Showing Likely Locations where Decay Could Develop

7.4 CROSSTIES.

7.4.1 Problems To Be Found. Crossties often are produced from small diameter, lower grade logs and, thus, contain a pith center. As a result, deep checking and end splitting can be a problem. “S” irons, dowels, and end plates (anti-splitting devices), driven into the ends of ties, are frequently used to prevent splitting. Tie plates to hold the rails are placed on the top side of the tie. A combination of metallic degradation of wood by these plates and heavy loadings can wear or crush the wood to the point where the preservative shell of the tie is broken or the structural integrity of the tie itself is destroyed.

7.4.2 Inspection Procedures. Inspection of ties in place is done by an experienced individual. The presence of excessive plate wear, loosened spikes or “spike kill”, deep checking, splitting, plant growth in ties, soft wood, etc., are indications that decay may be present. On heavily loaded tracks, the first signs of deterioration occur near the tie plate. On less heavily loaded lines, decay in the untreated portions of the tie may be more of a problem.

7.4.3 Remedial Treatment. Treatment to arrest existing decay may range from a simple surface application of creosote, pentachlorophenol or other preservative to pulling spikes, inserting a preservative into the hole and then re-driving the spikes. Application of preservative into the spike hole is intended to reduce wood metal interactions, thereby reducing the loosening of spikes. Small rods comprised of boric acid can also be inserted into holes drilled at angles under tie plates. This procedure is particularly effective in arresting decay in the vicinity of the tie plate.

Caution: Preservatives are toxic pesticides. The status of preservatives changes constantly because of regulatory actions. Therefore, installations should consult with the cognizant PMC to determine the most appropriate material for use in remedial treatments. Further, the label directions on preservative containers must be understood and adhered to, for the protection of humans and the environment.

APPENDIX A

AMERICAN WOOD-PRESERVERS' ASSOCIATION STANDARD

11-86

TABLE OF CONTENTS AND CHECK LIST

As of June 19, 1986

	Standard Number
Section 1. Introduction and Index	
Introduction, Table of Contents and Check List.....	11-86
Section 2. Preservatives	
Creosote.....	P1-78
Creosote and Creosote Solutions.....	P2-85
Creosote-Petroleum Oil Solution.....	P3-67
Petroleum Oil for Blending with Creosote.....	P4-86
Waterborne Preservatives.....	P5-86
Creosote for Brush or Spray Treatment for Field Cuts.....	P7-85
Oil-Borne Preservatives.....	P8-77
Standard for Solvents for Organic Preservative Systems.....	P9-84
Creosote-Pentachlorophenol Wood Preservative Solution.....	P11-70
Creosote-Coal Tar Solution for Use in Treatment of Marine (Coastal Waters) Piles and Timbers.....	P12-85
Coal Tar Creosote for Use in Treatment of Marine (Coastal Waters) Piles and Timbers.....	P13-85

Section 3. Commodities

All Timber Products, Pressure Treatment (General Requirements).....	C1-86
Lumber, Timbers, Bridge Ties and Mine Ties, Pressure Treatment.....	C2-85
Piles, Pressure Treatment	C3-86
Poles, Pressure Treatment.....	C4-86
Posts, Pressure Treatment.....	C5-84
Crossties and Switch Ties, Pressure Treatment.....	C6-83
Incised (Red, White and Yellow Cedar) Pole Butts, Thermal Treatment.....	C7-73
Poles (Western Red and Alaska Yellow Cedar), Full-Length Thermal Treatment	C8-73
Plywood, Pressure Treatment.....	C9-85
Poles (Lodgepole Pine), Full-Length Thermal Treatment.....	C10-73
Wood Blocks for Floors and Platforms, Pressure Treatment.....	C11-80
Poles (Western Larch), Full-Length Thermal Treatment	C12-83
Wood for Highway Construction, Pressure Treatment.....	C14-86
Wood for Commercial-Residential Construction, Preservative Treatment	C15-84
Wood Used on Farms, Pressure Treatment.....	C16-86
Playground Equipment Treated with Inorganic Preservatives--Preservative Treatment by Pressure Processes.....	C17-86
Material in Marine Construction, Pressure Treatment.....	C18-86
Structural Lumber, Fire-Retardant Pressure Treatment	C20-84
Pole Building Construction, Pressure Treatment	C23-84
Sawn Timber Piles Used for Residential and Commercial Building--Preservative Treatment by Pressure Processes	C24-86
Crossarms, Pressure Treatment	C25-85

Crossarms, Non-Pressure Treatment.....	C26-57
Plywood, Fire-Retardant Pressure Treatment	C27-84
Structural Glued Laminated Members and Laminations Before Gluing, Pressure Treatment	C28-85
Lumber to Be Used for the Harvesting, Storage and Transportation of Food Stuffs, Pressure Treatment.....	C29-82
Lumber for Cooling Towers, Pressure Treatment.....	C30-79

Section 4. Analysis Methods

Analysis of Creosote and Oil-Type Preservatives.....	A1-80
Analyses of Waterborne Preservatives and Fire-Retardant Formulations	A2-86
Determining Penetration of Preservatives.....	A3-84
Sampling Wood Preservatives.....	A4-80
Analyses of Oil-Borne Preservatives.....	A5-86
Determination of Water and Oil-Type Preservatives in Wood.....	A6-83
Wet Ashing Procedure for Preparing Wood for Chemical Analysis.....	A7-75
Qualitative Recovery of Creosote or Creosote-Coal Tar Solution for Freshly Treated Piles, Poles or Timber (Squeeze Method).....	A8-67
Analysis of Treated Wood and Treating Solutions by X-Ray Spectroscopy	A9-86
Analysis of CCA Treating Solutions and CCA Treated Wood by Colorimetry.....	A10-82
Analysis of Treated Wood and Treating Solutions by Atomic Absorption Spectroscopy	A11-83

Section 5. Miscellaneous Standards

Purchase of Treated Wood Products	M1-86
Inspection of Treated Timber Products.....	M2-83
Quality Control Procedures for Wood Preserving Plants	M3-81

Care of pressure-Treated Wood Products	M4-84
Glossary of Terms Used in Wood Preservation	M5-78
Brands Used on Forest Products.....	M6-86
Guideline for the Physical Inspection of Poles in Service	M13-72
Guide to Standards for Testing Plant Effluent	M15-74
Miscellaneous Methods, Procedures and Information.....	M17-78

Evaluation Standards

Standard Method of Evaluating Wood Preservatives by Field Tests with Stakes.....	M7-83
Standard Method for Field Tests with Posts (ASTM D-2278, Methods not identical)	M8-56
Standard Method of Testing Wood Preservatives by Laboratory Soil-Block Culture (ASTM D-1413, Methods are identical).....	M10-77
Standard Method to Determine the Comparative Leachability of Wood Preservatives (AWPA Proceedings, 1965, pps. 69-70)	M11-66
Standard Method for Laboratory Evaluation to Determine Resistance to Subterranean Termites (ASTM D-3345).....	M12-72
Standard Method of Conducting Controlled Velocity Laboratory Corrosion Tests.....	M14-72
Standard procedure for the Calculation of the “Performance Index” of Preservatives in Stake and Post Tests.....	M16-83
Standard Method of Testing Water Repellence of Pressure Treated Wood	M18-78
Standard Method of Evaluating Wood Preservatives for Marine Service by Means of Small Size Specimens (ASTM D-2481).....	M19-67
Standard Method for Determining the Equilibrium Moisture Content of Fire-Retardant Treated Wood	M20-83

Section 6. Conversion Factors and Correction Tables

Volume and Specific Gravity Correction Tables for Creosote, Creosote-Coal Tar Solution, and Coal Tar	F1-51
Abridged Volume Correction Tables for Petroleum Oils	F2-74

Volumes of Round Forest Products	F3-78
Volume Correction Factors for Creosote-Petroleum Solutions.....	F4-51
Volume Correction Factors for Preservative Salt Solutions.....	F5-51
Miscellaneous Conversion Factors and Correction Tables.....	F6-72

APPENDIX B

TT-W-00571J (AGR-AFS)
October 31 1974
INTERIM REVISION OF
Fed. Spec. TT-W-571i
October 28, 1968

INTERIM FEDERAL SPECIFICATION

WOOD PRESERVATION: TREATING PRACTICES

This Interim Federal Specification was developed by the U.S. Department of Agriculture, Forest Service, Forest Products Laboratory, P.O. Box 5130, Madison, Wisconsin 53705, based upon currently available technical information. It is recommended that Federal agencies use it in procurement and forward recommendations for changes to the preparing activity at the address shown above.

The United States Department of Agriculture has authorized the use of this Interim Federal Specification as a valid exception to Federal Specification TT-W-571i.

1. SCOPE

1.1 Scope. This specification covers the treatment of different forms and species of wood with various preservatives. It covers treatments of wood items that will be exposed to either moderate or severe hazard of attack by wood-destroying organisms so that an appreciable retention of preservative as well as significant penetration into wood is necessary. Such results are attainable by pressure processes which are acceptable for all products listed in tables I, II, and III. Certain other processes are acceptable for some items provided that they yield the retention and penetration requirements specified herein. These processes include thermal treatments of some species of poles, and double-diffusion treatments of posts, poles, and lumber. Reference is made to TT-W-572, Wood Preservative, Water Repellent, for the treatment of items such as window sash that are used under mild exposure conditions whereby adequate protection is afforded by short-dip treatments.

2. APPLICABLE DOCUMENTS

2.1 The following documents, of the issues in effect on date of invitation for bids or request for proposal, form a part of this specification to the extent specified herein:

Federal Specifications:

TT-C-645	Creosote, Coal Tar, Technical.
TT-C-650	Creosote-Coal Tar Solution.
TT-C-655	Creosote, Technical, Wood Preservative, (For) Brush Spray or Open-Tank Treatment.
TT-W-535	Wood Preservative; Fluoride-Chromate Aresenate-Phenol Mixture.
TT-W-546	Wood Preservative; Acid Copper Chromate Mixture.
TT-W-549	Wood Preservative; Ammoniacal Copper Arsenite Mixture.
TT-W-550	Wood Preservative; Chromated Copper Arsenate Mixture.
TT-W-551	Wood Preservative; Chromated Zinc Chloride Mixture.
TT-W-568	Wood Preservative; Creosote-Petroleum Solution.
TT-W-570	Wood Preservative; Pentachlorophenol, Solid.
TT-W-572	Wood Preservative; Water Repellent.
TT-W-1894	Wood Preservative; Tributyltin oxide.

(Activities outside the Federal Government may obtain copies of Federal Specifications, Standards, and Handbooks as outlined under General Information in the Index of Federal Specifications and Standards at the prices indicated in the Index. The Index, which includes cumulative monthly supplements as issued, is for sale on a subscription basis by the Superintendent of Documents, U.S. Government Printing Office, Washington, DC 20402.

(Single copies of this specification and other Federal Specifications required by activities outside the Federal Government for bidding purposes are available without charge from Business Service Centers at the General Services Administration Regional Offices in Boston, New York, Washington, DC, Atlanta, Chicago, Kansas City, MO, Fort Worth, Denver, San Francisco, Los Angeles, and Seattle, WA.

(Federal Government activities may obtain copies of Federal Specifications, Standards, and Handbooks and the Index of Federal Specifications and Standards from established distribution points in their agencies .)

2.2 Other publications. The following documents form a part of this specification to the extent specified herein. Unless a specific issue is identified, the issue in effect on date of invitation for bids or request for proposal shall apply.

American Wood-Preservers' Association (AWPA) Standards:

A1-Standard Methods for Analysis of Creosote and Oil-Type Preservatives.

A2-Standard Methods for Analysis of Waterborne Preservatives and Fire-Retardant Formulations.

A3-Standard Methods for Determining Penetration of Preservatives and Fire Retardants.

A4-Standard Methods for Sampling Wood Preservatives.

- A5-Standard Methods for Analysis of Oil-Borne Preservatives.
- A6-Method for the Determination of Oil-Type Preservatives and Water in Wood.
- A7-Standard Wet Ashing Procedure for Preparing Wood for Chemical Analysis.
- A8-Qualitative Recovery of Creosote or Creosote-Coal Tar Solution from Freshly Treated Piles, Poles, or Timber (Squeeze Method).
- A9-Standard Method for Analysis of Treated Wood and Treating Solutions by X-ray Emission spectroscopy.
- A10-Standard Methods of Analysis of CCA Treating Solutions and CCA Treated Wood by Colorimetry.
- C1-All Timber Products- Preservative Treatment by Pressure Processes.
- C2-Lumber, Timbers, Bridge Ties, and Mine Ties-Preservative Treatment by Pressure Processes.
- C3-Piles--Preservative Treatment by Pressure Processes.
- C4-Poles--Preservative Treatment by Pressure Processes.
- C5-Fenceposts--Preservative Treatment by Pressure Processes.
- C6-Crossties and Switch Ties--Preservative Treatment by Pressure Processes.
- C8-Western Redcedar and Alaska Yellow-Cedar Poles-Preservative Treatment by the Full-Length Thermal Process.
- C9-Plywood--Preservative Treatment by Pressure Processes.
- C10-Lodgepole Pine Poles--Preservative Treatment by the Full-Length Thermal Process.
- C14-Wood for Highway Construction--Preservative Treatment by Pressure Processes.
- C16-Wood Used on Farms--Preservative Treatment by Pressure Processes.
- C18-Standard for Pressure--Treated Piles and Timbers in Marine Construction.
- C23-Round Poles and Posts Used in Building Construction--Preservative Treatment by Pressure.
- C28-Standard for Preservative Treatment of Structural Glued Laminated Members and Laminations Before Gluing of Southern Pine, Pacific Coast Douglas-fir, and Western Hemlock by Pressure Processes.

M2-Standard for Inspection of Treated Timber Products.

M3-Standard Quality Control Procedures for Wood Preserving Plants.

M4-Standard for the Care of Pressure-Treated Wood Products.

M5-Glossary of Terms Used in Wood Preservation.

M6-Brands Used on Forest Products.

P4-Standard for Petroleum Oil for Blending with Creosote.

P8-Standards for Oil-Borne Preservatives.

P9-Standards for Solvents for Oil-Borne Preservatives.

(Copies of the Standards and Instructions of the American Wood-Preservers' Association may be obtained from its Secretary-Treasurer, 1625 Eye Street, N.W., Washington, D.C. 20006. Prices may be obtained from the secretary-treasurer.

Technical society and technical association specification standards are generally available for reference from libraries. They are also distributed among technical groups and using Federal agencies.

3. REQUIREMENTS

3.1 General requirements. Since difficulty may be encountered in obtaining the specified retention and penetration, it is the responsibility of the supplier to select piles, poles, and posts for treatment that have sufficient sapwood thickness to permit obtaining the retention and penetration specified. Suitable conditioning and, for some species, incising prior to treatment and the use of treating conditions which do not damage the wood according to AWWA standards C1 and M3, are further responsibilities of the supplier (see 3.4 and 3.5). Unless otherwise specified in the contract or purchase order (see 6.2), the treatment of various products and species shall be in accordance with tables I, II and III and footnotes thereto. Inspection of treated products shall be made in accordance with paragraphs 4.2 to 4.2.7 inclusive. Whenever differences exist between this specification and corresponding industry specifications, the requirements of this specification shall prevail.

3.2 Segregation of material for treatment. The material shall be separated or spaced so as to insure contact of treating medium with all surfaces. Whenever the quantity of material ordered is sufficient, items of different species, size, conditioning, and retention requirements shall be treated in separate charges.

3.3 Empty-and full-cell processes. Empty-cell treatment shall be used with preservative oils and oil-borne preservatives except when the retention specified is greater than can be obtained by an empty-cell process. Water-borne preservatives shall be injected by the full-cell process whenever the product is to be used in coastal waters or in foundations. A modified full-cell process, as described in AWWA Standard C1, may be used for plywood and sawn material less than 5 inches in thickness and not in-

tended for use in marine exposure or foundations. Control over wood temperature is essential in treating wood with waterborne preservatives containing chromates which are unstable in contact with wood at high temperatures.

3.4 Seasoning. Green material shall be adequately seasoned or conditioned before impregnation with preservative. This practice applies particularly to sawn material that is difficult to penetrate and to round material of thin sapwood species. All sawn material that is to be treated with an oil-type preservative and used in buildings or other places where high-moisture content or shrinkage after installation would be objectionable shall be dried before treatment. When sawn material is treated with a permanent-type, chromium-containing preservative, such as chromated copper arsenate, the moisture content prior to treatment as determined by resistance-type moisture meter, shall not be more than 25 percent. The moisture content shall be measured at a depth equivalent to the required penetration up to a maximum of 1.5 inches. When treated with other waterborne preservatives, sawn material shall be suitably seasoned or conditioned prior to treatment. Unless otherwise specified (see 6.2), lumber 2 inches (nominal) or less in thickness and plywood that is treated with a waterborne preservative shall be dried after treatment to a moisture content of not more than 19 percent.

3.5 Incising. All lumber and timbers of species that are difficult to penetrate, such as Douglas-fir, Western larch, western hemlock, redwood, and pines that are predominantly heartwood, shall be incised prior to treatment, provided the incisions will not make the material unfit for the use intended.

3.6 Marking. Unless otherwise specified (see 6.2), treated material shall be either hammer or heat branded, dye stamped, or metal tagged in accordance with AWWA Standards M1 and M6. Information shall be included for specific commodities, as given in the following:

3.6.1 Poles 50 feet or less in length shall be branded or tagged 10 feet from the butt. Poles 55 feet or more in length shall be branded or tagged 14 feet from the butt. All poles shall have the required branding or tagging included on the butt face. The brand shall identify species, class and length, preservative, retention, supplier, and year of treatment.

3.6.2 Piles shall be branded or tagged in two places approximately 5 and 10 feet from the butt. The brand shall identify species, class and length, preservative, retention, supplier, and year of treatment.

3.6.3 Posts shall be branded or tagged at or within 12 inches of the top. The brand shall identify preservative, supplier, and year of treatment.

3.6.4 Crossties shall be branded at least on one end. The brand shall identify preservative, supplier, and year of treatment.

3.6.5 Crossarms shall be branded on one face. The brand shall identify preservative, supplier, and year of treatment.

3.6.6 Sawn material more than 2 inches (nominal) in thickness and treated with an oil-type preservative shall be individually branded or tagged on one end to identify species, preservative, retention, supplier, and year of treatment. When treated with a waterborne preservative, it may be dye stamped on the surface.

3.6.7 Sawn material less than 2 inches in thickness or plywood when treated with an oil-type preservative may be bundled with tags being attached to the bundles to identify species, preservative, retention, supplier, and year of treatment. In lieu of tags attached to bundles, when such material is treated with a waterborne preservative, the required information may be dye stamped on the outer pieces of a bundle.

4. QUALITY ASSURANCE PROVISIONS.

4.1 The Government reserves the right to perform and/or retain services for any of the inspections set forth in the specification where such inspections are deemed necessary to assure that supplies and services conform to prescribed requirements. Tests to verify the accuracy of inspection reports furnished by the supplier shall be made either by employees of the purchaser or by commercial inspection companies retained by the purchaser. The purchaser may elect to employ the services and accept the stamp or brand of an independent quality control agency. When treated wood, as specified by a Government agency, is procured by a contractor for the construction of a building or other facility for that agency, the contractor shall submit to that agency an inspection report from an independent commercial inspection company acceptable to the purchaser. An omission of this inspection report is permissible if the treated wood bears the brand or stamp of an independent quality control agency acceptable to the purchaser. In the invitation for bids, the purchaser will designate the general procedure to be used in confirming the quality of the product.

4.1.1 Unless otherwise specified in the contract or purchase order, the supplier is responsible for the performance of all inspection requirements as specified herein, and complete inspection records shall be furnished either to the purchaser's office or otherwise stipulated in the order or contract.

4.1.2 Except as otherwise specified, the supplier may utilize his own or any other inspection facilities and services acceptable to the Government (see 4.1).

4.1.3 Inspection of the untreated stock shall be made in a period within 10 days of treatment.

4.1.4 The Government reserves the right to conduct or retain services for inspections at destination. When the results obtained at destination disagree with those obtained at origin, the results of the destination inspection shall be binding.

4.1.5 When inspection is made at destination, it will be made within 30 days of delivery. AWPA methods of assay will be used and an assay retention of 90 percent of the stipulated assay retention will be accepted as conforming. (See footnote 10, table II).

4.2 Instructions. Unless otherwise specified, AWPA Standard M2 (with certain exceptions as given below) shall be followed, in the inspection of all treated wood purchased by the Government.

4.2.1 Penetration. In the inspection of piles, building poles, building posts, or Group B utility poles (37.5 in. or more in circumference 6 ft from the butt), each piece shall be bored at the approximate midpoint for the determination of penetration. Any piece that does not show the specified penetration shall be rejected. If 15 percent or more of the pieces in any charge or lot of piles, building poles,

Group B utility poles, or building posts fail to meet penetration requirements, the entire charge or lot shall be rejected.

In determining the penetration in Group A utility poles (less than 37.5 in. in circumference 6 ft from the butt), 20 representative poles in a charge shall be bored at the approximate midpoint. If 18 of the borings meet penetration requirements, the Group A poles in the charge as a whole shall be accepted, but the nonconforming poles shall be rejected. If 16 or 17 of the borings meet penetration requirements, each Group A pole in the charge shall be bored and only those meeting penetration requirements shall be accepted. If less than 16 of the borings meet penetration requirements, the charge shall be rejected.

4.2.2 Retention. For the assay of a charge of poles, a single boring shall be taken from each of 20 randomly selected poles. For the assay of piles, the number of borings from any charge shall be according to the following schedule:

Number of piles in charge	Number of borings
20 or more	20 from 20 randomly selected piles
15 to 19	One from each pile
Less than 15	At least 20, with an equal number from each pile

The borings shall be cut to the proper length from the species as shown in Tables II and III.

4.2.3 In the inspection of treated round fence posts, 30 representative posts of a lot shall be bored for measurement of penetration. If less than 80 percent of the borings show the specified penetration, the entire charge shall be rejected. If 80 percent or more of the borings meet the penetration requirement, a composite sample of one boring from each of 30 posts shall be taken for assay. The borings for assay shall be cut to the proper length for the species as shown in table II. The inspection of sawn posts shall be conducted according to the procedure outlined in 4.2.4 for the inspection of treated timbers.

4.2.4 In the inspection of treated lumber or solid timbers, 20 representative pieces of a lot shall be bored for measurement of penetration. Southern and ponderosa pine shall be bored from sapwood faces only. Douglas-fir, western hemlock, western larch, redwood and other species of pine shall be bored from heartwood faces only. If 80 percent or more of the borings meet the penetration requirements, the lot is considered to meet penetration requirements. For laminated timbers, see footnote 7. For the assay of treated southern and ponderosa pine lumber or timber, a composite sample of the outer 0.60 inch of borings shall be taken from sapwood. For the assay of Douglas-fir, western hemlock, western larch, redwood, and other species of pine lumber or timber, a composite sample of the outer 0.60 inch of borings shall be taken from heartwood. Single borings shall be taken from 48 representative pieces treated with creosote or creosote-containing solutions, and from 20 representative pieces

treated the pentachlorophenol or waterborne preservatives. Retentions in lumber or timbers of species not mentioned above shall be determined by gage readings.

4.2.5 In the inspection of treated plywood, penetration shall be determined by taking borings 12 inches from any edge into one face of each of not less than five panels in any lot. Borings shall be tested for penetration by the appropriate procedure described in AWPA Standard A3. Penetration in plywood shall be considered adequate if each veneer is penetrated. For the assay of treated plywood, samples shall be taken from not less than five panels in each lot. These samples shall be taken at a point 12 inches from any edge. Plywood 5/8 inch or less in thickness shall be sampled through the full thickness. Plywood more than 5/8 inch in thickness shall be sampled from the lower grade face to a depth of 5/8 inch.

4.2.6 The determination of the amount of creosote or creosote-containing solutions in a sample of borings shall be made according to AWPA Standard A6. The determination of the amount of pentachlorophenol in a sample of borings shall be made according to AWPA Standard A5. The determination of the amounts of waterborne preservatives in a sample of borings shall be made according to AWPA Standard A2.

4.2.7 To obtain and test a sample of oil from a marine piling for compliance with quality requirements, AWPA Standards A8 and A1 shall be used.

5. PREPARATION FOR DELIVERY

5.1 This section is not applicable to this specification.

6. NOTES

6.1 Recommended practices in the procurement and use of treated wood.

6.1.1 Tables I, II, and III are schedules of approved practices for the preservative treatment of wood in various forms with creosote and creosote-containing solutions, pentachlorophenol, and waterborne preservatives which are intended for Government use. The net retentions in the tables are minimal. Higher net retentions may be needed for severe use conditions and should be specified, they should also be specified for moderate use conditions whenever a product is of critical structural importance or whenever it is used in a situation where replacement would be very costly. It is recommended that observations of penetration be made on a number of pieces selected at random from each shipment received at destination. The presence or absence of the mark of a quality control agency or independent inspection agency acceptable to the purchaser should also be noted. When the wood contains such a mark and the penetration observed conforms to the specifications, the shipment may be accepted. When the penetration observed casts doubt on the quality of the treatment, a thorough inspection by either the Government, a quality control agency, or an independent inspection agency should be made and any nonconforming shipment or lot should be rejected.

6.1.2 Coal-tar creosote, creosote-coal tar solution, creosote-petroleum solution, pentachlorophenol, and the four waterborne preservatives ACA, CCA Type I, CCA Type II, and CCA Type III (Tables I, II, and III) are ordinarily to be used for wood exposed to severe exposure conditions, such as

contact with soil or water and for important above ground structures exposed to the weather. Since oil-type preservatives, in addition to affording protection against decay, also retard weathering and checking, they are generally preferable to waterborne preservatives for the treatment of sawn wood that has no exacting requirements on cleanliness or odor and is to be used in contact with the ground. If cleanliness, freedom from odor, or paintability are desirable, either of the four waterborne preservatives mentioned above will give good protection to sawn wood in ground contact provided that the wood is selected for its receptiveness to treatment and treated to meet the minimum penetration and retention requirements listed herein.

6.1.3 Painting of treated wood involves special considerations. Wood treated with creosote, solutions containing creosote, and pentachlorophenol in heavy petroleum solvent, cannot ordinarily be painted satisfactorily. When requested, it can be conditioned by the producer to improve its cleanliness. Difficulties may be encountered in painting wood treated with pentachlorophenol in a light petroleum solvent. When purchasing wood treated with such solutions, the supplier should be required to designate a type or brand of paint that will give satisfactory results on wood so treated. Wood treated with waterborne preservatives should be properly seasoned after treatment (see 3.4) and may require 1 ght brushing or sanding in order to provide a paintable product. Since “cleanliness” is a relative term, it is recommended that the purchaser make known his specific requirements and the end use of the material, and that the supplier be required to furnish evidence that the material be suitable for that use. In the absence of widely used methods for determining cleanliness, paintability, and water repellency of pentachlorophenol-treated wood, the purchaser may elect to use arbitrary test methods or those described in Federal specification TT-W-572.

6.1.4 The serviceability of treated wood is impaired through cutting or damage to the treated surface. Whenever it is possible, machining, cutting, trimming, etc., should be done prior to treatment. When cutting or damage to the surface of treated wood cannot be avoided, the instructions given in AWWA Standard M4 should generally be followed. Cut surfaces of wood treated with oil borne preservatives should be given at least two brush applications of either creosote or a solution of at least 5 percent pentachlorophenol in a suitable solvent, or one heavy application of a grease or suitably bodied preservative composition containing at least 10 percent pentachlorophenol. Cut surfaces of wood treated with a waterborne preservative should be given one application of a concentrated solution of the preservative used in the treatment. (See AWWA Standard M4). The choice should be based upon cleanliness requirements.

6.2 Ordering data. Purchasers should select the preferred options permitted herein, and include the following information in procurement documents:

- (a) Title, number, and date of this specification.
- (b) Moisture content required at acceptance (see 3.4).
- (c) Minimum information required in the branding or marking (see 3.6).
- (d) Treatment other than normally required (see 3.1).

- (e) Condition of surface following treatment (see 6.1.2 and 6.1.3).

6.3 Invitation for bids. Invitations for bids should state the quantity, form, species, grade, the fabrication of the wood, the preservatives and retentions required, the treatment specifications to be complied with, and also any special requirements, such as cleanliness, paintability, water repellency, and drying of timbers after treatment with waterborne preservatives.

Form of product and service conditions	Penetration	Assay Zone	Minimum net retention of active preservative ^{1/}										Treating specifications ^{2/} (AWPA C1 and others listed below)		
			Pentachlorophenol (Fed. Spec. TT-W-570)												
			Coal-tar creosote (Fed. Spec. TT-C-645)	Creosote-coal tar solution (Fed. Spec. TT-C-650)	Creosote-petroleum solution (Fed. Spec. TT-W-568)	5.0 to 7.5 % solution with heavy petroleum solvent (AWPA P9 type A)	In solution with light petroleum solvent (AWPA P9 type C)	In solution with volatile solvent (AWPA P9 type B)	Acid copper chromate (Fed. Spec. TT-W-546)	Ammoniacal copper arsenite (Fed. Spec. TT-W-549)	Chromated copper arsenate type I, type II, or type III (Fed. Spec. TT-W-550)	Chromated zinc chloride (Fed. Spec. TT-W-551)	Fluor chrome-arsenate-phosol mixture (Fed. Spec. TT-W-535) type I or type II	Tributyl-tin-oxide (Fed. Spec. TT-W-1894)	
	In. and/or pct of sapwood	In.	Pounds per cubic foot												
<u>Ties</u>															
<u>Crossties, switch ties, and bridge ties</u>															
Beech, birch, and maple	85	Gage only	7.0	7.0	7.0	0.35	--	--	--	--	--	--	--	--	C2 and C6
Red oak	65 pct of rings	...do...	-----Refusal-----												
Black and red gum	1.5 or 75	...do...	10.0	10.0	10.0	0.50	--	--	--	--	--	--	--	--	
Ash, black and honey locust, hickory black walnut, white oak, and interior Douglas-fir	90	...do...	-----Refusal-----												
Coastal Douglas-fir, western hemlock, and western larch	0.5 and 90	...do...	8.0	8.0	8.0	0.40	--	--	--	--	--	--	--	--	
Southern and ponderosa pines	2.5 or 85	...do...	8.0	8.0	8.0	0.40	--	--	--	--	--	--	--	--	
Jack, lodgepole, and red pines	0.5 or 90	...do...	7.0	7.0	7.0	0.35	--	--	--	--	--	--	--	--	
<u>Timbers^{2/}:</u>															
<u>Solid</u>															
For use in coastal waters															
In areas where <u>Limnoria tripunctata</u> and pholads are known to be active, or in southern areas for which information on the borer hazard is lacking the dual treatment shall be used (see table III)															
In areas where moderate to heavy <u>limnoria</u> attack is expected but pholads are absent															
Coastal Douglas Fir	0.75 and 90	0-0.60	--	--	--	--	--	--	--	2.50	2.50	--	--	--	C2, C14, C16, and C18
Western hemlock	0.75 and 90	0-0.60	--	--	--	--	--	--	--	2.50	2.50	--	--	--	
Southern Pine	2.50 or 85	0-0.60	--	--	--	--	--	--	--	2.50	2.50	--	--	--	

Treatment of Sawn Wood Products

TABLE I

Form of product and service conditions	Penetration	Assay Zone	Minimum net retention of active preservative ¹⁾											Treating specifications ²⁾ (AWPA C1 and others listed below)
			Pentachlorophenol (Fed. Spec. TT-W-570)											
	In. and/or pct of sapwood	In.	Coal-tar creosote (Fed. Spec. TT-C-645)	Creosote-coal tar solution (Fed. Spec. TT-C-650)	Creosote-petroleum solution (Fed. Spec. TT-W-568)	5.0 to 7.5 % solution with heavy petroleum solvent(AWPA P9 typeA)	In solution with light petroleum sol- vent(AWPA P9 type C)	In solution with volatile solvent (AWPA P9 type B)	Acid copper chromate (Fed. Spec. TT-W-546)	Ammoniacal copper arsenite (Fed. Spec. TT-W-549)	Chromated copper arsenate type I, type II, or type III (Fed. Spec. TT-W-550)	Chromated zinc chloride (Fed. Spec. TT-W-551)	Fluor chrome-arsenate- phenol mixture (Fed. Spec. TT-W-535) type I or type II	Tributyl-tin-oxide (Fed. Spec. TT-W-1894)
			Pounds per cubic foot											
Timbers--cont.														
Solid--cont.														
In areas where <u>teredo</u> are present with light <u>limnoria</u> activity														
Coastal Douglas-fir	0.75 and 90	0-0.60	³ /25.0	--	--	--	--	--	--	2.50	2.50	--	--	--
Western Hemlock	0.75 and 90	0-0.60	³ /25.0	--	--	--	--	--	--	2.50	2.50	--	--	--
Southern pine	2.50 or 85	0-0.60	³ /25.0	--	--	--	--	--	--	2.50	2.50	--	--	--
In areas where <u>teredo</u> are present with no <u>limnoria</u> activity														
Coastal Douglas-fir and western hemlock	0.75 and 90	0-0.60	⁵ /20.0	--	--	--	--	--	--	--	--	--	--	--
Southern pine	2.50 or 85	0-0.60	⁵ /20.0	--	--	--	--	--	--	--	--	--	--	--
For other important structural members used in fresh water or in ground contact														
Coastal Douglas-fir and western larch	0.75 and 90	0-0.60	12.0	12.0	12.0	0.60	--	--	--	0.60	0.60	--	--	--
Western Hemlock	0.75 and 90	0-0.60	12.0	12.0	12.0	0.60	--	--	--	0.60	0.60	--	--	--
Southern pine	2.50 or 85	0-0.60	12.0	12.0	12.0	0.60	--	--	--	0.60	0.60	--	--	--
For other timbers used in fresh water or in ground contact														
Coastal Douglas-Fir, western larch, and redwood	0.75 and 90	0-0.60	10.0	10.0	10.0	0.50	0.62	0.62	0.50	0.40	0.40	--	--	--
Western hemlock, jack, lodgepole, sugar, red, northern white, and western white pines	0.75 and 90	0-0.60	10.0	10.0	10.0	0.50	0.62	0.62	0.50	0.40	0.40	--	--	--
Southern and ponderosa pines	2.50 of 85	0-0.60	10.0	10.0	10.0	0.50	0.62	0.62	0.50	0.40	0.40	--	--	--

Treatment of Sawn Wood Products (continued)

TABLE I

TABLE I

Treatment of Sawn Wood Products (continued)

Form of product and service conditions	Penetration	Assay Zone	Minimum net retention of active preservative/ pentachlorophenol (Fed. Spec. TT-W-570)		Pounds per cubic foot		Treating specifications/ (AWPA Cl and others listed below)
			In.	and/or pct. of sapwood	In.	and/or pct. of sapwood	
Timbers--cont. Solid--cont.							
Coastal Douglas-fir; western hemlock; western larch; redwood; jack, lodgepole, red, northern white, and sugar pines Southern and ponderosa pines	(8) 0.5 and 90	0-0.60	8.0	0.40	0.40	0.40	0.25 0.45 0.25
Glued-laminated For use in coastal waters In areas where <u>Limnoria</u> <u>tripunctata</u> and <u>pholads</u> are known to be active, or in southern areas for which information on the borer hazard is lacking the dual treatment shall be used (see Table III)	(7)	(9)	8.0	0.40	0.40	0.40	0.25 0.45 0.25
In areas where moderate to heavy <u>limnoria</u> attack is expected but <u>pholads</u> are absent							
Coastal Douglas-fir Western hemlock Southern, ponderosa, and red pines	0.75 and 90 0.75 and 90 2.50 or 85	0-0.60 0-0.60 0-3.00	-- -- --	-- -- --	-- -- --	-- -- --	-- -- --
In areas where teredo are present with light <u>limnoria</u> activity							
Coastal Douglas-fir Western hemlock Southern, ponderosa, and red pines	0.75 and 90 0.75 and 90 2.50 or 85	0-0.60 0-0.60 0-3.00	-- -- 3/25.0	-- -- 3/25.0	-- -- 4/25.0	-- -- --	-- -- --

Form of product and service conditions	Penetration	Assay zone	Minimum net retention of active preservative ¹													Treating specifications ² (AWPA C1 and others listed below)
			Pentachlorophenol (Fed. Spec. TT-W-570)													
			Coal-tar creosote (Fed. Spec. TT-C-645)	Creosote-coal tar solution (Fed. Spec. TT-C-650)	Creosote-petroleum solution (Fed. Spec. TT-W-568)	5.0 to 7.5 % solution with heavy petroleum solvent (AWPA P9 type A)	In solution with light petroleum solvent (AWPA P9 type C)	In solution with volatile solvent (AWPA P9 type B)	Acid copper chromate (Fed. Spec. TT-W-546)	Ammoniacal copper arsenite (Fed. Spec. TT-W-549)	Chromated copper arsenate type I, type II, or type III (Fed. Spec. TT-W-550)	Chromated zinc chloride (Fed. Spec. TT-W-551)	Fluor chrome-arsenate-phosphite mixture (Fed. Spec. TT-W-555) type I or type II	Tributyl-tin-oxide (Fed. Spec. TT-W-1894)		
	In. and/or pct of sapwood	In.	-----Pounds per cubic foot-----													
<u>Timbers (cont.)</u>																
Glue-laminated-cont.																
For use in coastal waters-cont.																
In areas where <u>teredo</u> are present with no <u>limnoria</u> activity																
Coastal Douglas-fir and western hemlock	0.75 and 90	0-0.60	⁵ /20.0	--	--	--	--	--	--	--	--	--	--	--	--	
Southern, ponderosa, and red pines	2.50 or 85	0-3.00	⁵ /20.0	⁶ /20.0	--	--	--	--	--	--	--	--	--	--	--	
For use in fresh water, in ground contact, or for important structural members not in contact with ground or water																
Southern pine, coastal Douglas-fir, and western hemlock	(7)	(9)	12.0	12.0	12.0	0.60	0.75	0.75	--	--	--	--	--	--	--	
For use above ground																
Southern pine, coastal Douglas-fir, and western hemlock	(8)	(9)	6.0	6.0	6.0	0.30	0.30	0.30	--	--	--	--	--	--	--	
Laminates prior to gluing																
For use in ground contact																
Coastal Douglas-fir	1.25	0.5-1.00	12.0	--	--	0.60	0.75	0.75	0.50	0.40	0.40	--	--	--	--	
Western hemlock	1.25	0.5-1.00	12.0	--	--	0.60	0.75	0.75	0.50	0.40	0.40	--	--	--	--	
Southern pine	3.00 or 90	0.5-1.00	12.0	--	--	0.60	0.75	0.75	0.50	0.40	0.40	--	--	--	--	
For use above ground																
Coastal Douglas-fir and western hemlock	1.00	0.5-1.00	6.0	--	--	0.30	0.30	0.30	0.25	0.25	0.25	--	--	--	--	
Southern pine	3.00 or 90	0.5-1.00	6.0	--	--	0.30	0.30	0.30	0.25	0.25	0.25	--	--	--	--	

C28

TABLE I
 Treatment of Sawn Wood Products (continued)

Form of product and service conditions	Penetration	Assay Zone	Minimum net retention of active preservative ¹⁾										Treating specifications ²⁾ (AWPA C1 and others listed below)	
			Pentachlorophenol (Fed. Spec. TT-W-570)											
			Coal-tar creosote (Fed. Spec. TT-C-645)	Creosote-coal tar solution (Fed. Spec. TT-C-650)	Creosote-petroleum solution (Fed. Spec. TT-W-568)	5.0 to 7.5 % solution with heavy petroleum solvent (AWPA P9 type A)	In solution with light petroleum sol- vent (AWPA P9 type C)	In solution with volatile solvent (AWPA P9 type B)	Acid copper chromate (Fed. Spec. TT-W-546)	Ammoniacal copper arsenite (Fed. Spec. TT-W-549)	Chromated copper arsenate type I, type II, or type III (Fed. Spec. TT-W-550)	Chromated zinc chloride (Fed. Spec. TT-W-551)	Fluor chrome-arsenate- phenol mixture (Fed. Spec. TT-W-555) type I or type II	Tributyl-tin-oxide (Fed. Spec. TT-W-1894)
	In. and/or pct. of sapwood	In.	-----pounds per cubic foot-----											
Lumber:														
For use in coastal waters														
In areas where <u>Limnoria tripunctata</u> and pholads are known to be active, or in southern areas for which information on the borer hazard is lacking the dual treatment shall be used (see table III)														
In areas where moderate to heavy <u>limnoria</u> attack is expected but pholads are absent														
Coastal Douglas Fir	0.50 and 90	0-0.60	--	--	--	--			--	2.50	2.50	--	--	--
Western hemlock	0.50 and 90	0-0.60	--	--	--	--			--	2.50	2.50	--	--	--
Southern, ponderosa, and red pines	0.75 or 85	0-0.60	--	--	--	--			--	2.50	2.50	--	--	--
In areas where <u>teredo</u> are present with light <u>limnoria</u> activity														
Coastal Douglas-fir	0.50 and 90	0-0.60	^{3/} 25.0	--	--	--	--	--	--	2.50	2.50	--	--	--
Western hemlock	0.50 and 90	0-0.60	3/25.0	--	--	--	--	--	--	2.50	2.50	--	--	--
Southern, ponderosa, and red pines	0.75 or 85	0-0.60	^{3/} 25.0	^{4/} 25.0	--	--	--	--	--	2.50	2.50	--	--	--
In areas where <u>teredo</u> are present with no <u>limnoria</u> activity														
Coastal Douglas-fir and western hemlock	0.50 and 90	0-0.60	^{5/} 20.0	--	--	--	--	--	--	--	--	--	--	--
Southern, ponderosa, and red pines	0.75 or 85	0-0.60	^{5/} 20.0	^{6/} 20.0	--	--	--	--	--	--	--	--	--	--

Treatment of Sawn Wood Products (continued)

TABLE I

Form of product and service conditions	Penetration	Assay Zone	Minimum net retention of active preservative ¹										Treating specifications ² (AWPA C1 and others listed below)	
			Pentachlorophenol (Fed.Spec. TT-W-570)											
			Coal-tar cresosote (Fed.Spec. TT-C-645)	Cresosote-coal tar solution (Fed.Spec. TT-C-650)	Cresosote-petroleum solution (Fed.Spec. TT-W-568)	5.0 to 7.5 % solution with heavy petroleum solvent (AWPA P3 type A)	In solution with light petroleum solvent (AWPA P9 type C)	In solution with volatile solvent (AWPA P9 type B)	Acid copper chromate (Fed.Spec. TT-W-546)	Ammoniacal copper arsenite (Fed.Spec. TT-W-549)	Chromated copper arsenite type I, III (Fed.Spec. TT-W-550)	Chromated zinc chloride (Fed.Spec. TT-W-551)	Fluor chrome-arsenate-phenol mixture (Fed.Spec. TT-W-535) type I or type II	Tributyl-tin-oxide (Fed.Spec. TT-W-1894)
	In. and/or pct of sapwood	In.	Pounds per cubic foot											
Lumber (cont.)														
For use in fresh water in ground contact or for important structural members not in contact with ground or water														
Coastal Douglas-fir, western hemlock, western larch, and redwood	0.4 and 90	0-0.60	10.0	--	10.0	0.50	0.62	0.62	0.50	0.40	0.40	--	--	--
Southern and ponderosa pines	2.5 or 85	0-0.60	10.0	10.0	10.0	0.50	0.62	0.62	0.50	0.40	0.40	--	--	--
Jack, lodgepole, red, northern white, western white, and sugar pines	0.4 and 90	0-0.60	10.0	10.0	10.0	0.50	0.62	0.62	0.50	0.40	0.40	--	--	--
Interior Douglas-fir	90	0-0.60	10.0	--	10.0	0.50	0.62	0.62	0.50	0.40	0.40	--	--	--
Black or red gum	1.5 or 75	0-0.60	8.0	--	8.0	0.40	0.50	0.50	0.50	0.40	0.40	--	--	--
Red Oak	65 pct of annual rings	0-0.60	7.0	7.0	7.0	0.35	0.44	0.44	0.50	0.40	0.40	--	--	--
White oak	95 pct of sapwood	--	-----Refusal-----										--	
For use above ground														
Coastal Douglas-fir, western hemlock, western larch, and redwood	0.4 and 90	0-0.60	8.0	8.0	8.0	0.40	0.40	0.40	0.25	0.25	0.25	0.45	0.25	0.06
Southern and ponderosa pines	2.5 or 85	0-0.60	8.0	8.0	8.0	0.40	0.40	0.40	0.25	0.25	0.25	0.45	0.25	0.06
Jack, lodgepole, red, northern white, western white, and sugar pines	0.4 and 90	0-0.60	8.0	8.0	8.0	0.40	0.40	0.40	0.25	0.25	0.25	0.45	0.25	0.06
Interior Douglas-fir	90	0-0.60	8.0	8.0	8.0	0.40	0.40	0.40	0.25	0.25	0.25	0.45	0.25	0.06
Slack or red gum	1.5 or 75	0-0.60	6.0	6.0	6.0	0.30	0.30	0.30	0.25	0.25	0.25	0.45	0.25	0.06
Red Oak	65 pct of annual rings	0-0.60	6.0	6.0	6.0	0.30	0.30	0.30	0.25	0.25	0.25	0.45	0.25	0.06
White Oak	95 pct of sapwood	--	-----Refusal-----										--	
Posts (sawn)			See requirements on timbers for use in ground contact										C2,C14, C16	

Treatment of Sawn Wood Products (continued)

TABLE I

Form of product and service conditions	Penetration	Assay zone	Minimum net retention of active preservative ¹ Pentachlorophenol (Fed. Spec. TT-W-570)										Treating specifications ² (AWPA C1 and others listed below)	
			Coal tar creosote (Fed. Spec. TT-C-645)	Creosote-coal tar solution (Fed. Spec. TT-C-650)	Creosote-petroleum solution (Fed. Spec. TT-W-568)	5.0 to 7.5 % solution with heavy petroleum solvent (AWPA P9 type A)	In solution with light petroleum solvent (AWPA P9 type C)	In solution with volatile solvent (AWPA P9 type B)	Acid copper chromate (Fed. Spec. TT-W-546)	Ammoniacal copper arsenite (Fed. Spec. TT-W-549)	Chromated copper arsenate type I, type II, or type III (Fed. Spec. TT-W-550)	Pounds		per cubic foot
	In. and/or pct. of sapwood	In.												
<u>Piles:</u>														
For use in coastal waters														
In areas where <u>Limnoria tripunctata</u> and <u>pholads</u> are known to be active or in southern areas for which information on the borer hazard is lacking the dual treatment shall be used (see table III)														
In areas where moderate to heavy <u>limnoria</u> attack is expected but <u>pholads</u> are absent														
coastal Douglas-fir	1.00 and 85	0-1.0	--			--	--	--	--	--	2.50	2.50		
Southern pine	4.00 or 90	0-0.5	--			--	--	--	--	--	2.50	2.50		
		0.5-2.0	--			--	--	--	--	--	1.50	1.50		
In areas where <u>teredo</u> are present with light <u>limnoria</u> activity														
Coastal Douglas-fir	1.00 and 85	0-2.0	^{3,10/} 22.0	--		--	--	--	--	--	--	--	--	--
Southern pine	4.00 or 90	0-3.0	^{3,10/} 25.0	^{4,10/} 25.0	--	--	--	--	--	--	--	--	--	--
In areas where <u>teredo</u> are present with no <u>limnoria</u> activity														
Coastal Douglas-fir	1.00 and 85	0-2.0	^{5/} 20.0	--		--	--	--	--	--	--	--	--	--
Southern pine	4.00 or 90	0-3.0	^{5/} 20.0	^{6/} 20.0	--	--	--	--	--	--	--	--	--	--

C3

TABLE II
Treatment of Round Wood Products

Form of product and service conditions	Penetration	Assay Zone	Minimum net retention of active preservative ¹¹ Pentachlorophenol (Fed. Spec. TT-W-570)										Treating specifications ¹² (AWPA C1 and others listed below)		
			Coal-tar creosote (Fed. Spec. TT-C-645)	Creosote-coal tar solution (Fed. Spec. TT-C-650)	Creosote-petroleum solution (Fed. Spec. TT-W-568)	5.0 to 7.5 % solution with heavy petroleum solvent (AWPA P9 type A)	In solution with light petroleum solvent (AWPA P9 type C)	In solution with volatile solvent (AWPA P9 type B)	Acid copper chromate (Fed. Spec. TT-W-546)	Ammoniacal copper arsenite (Fed. Spec. TT-W-549)	Chromated copper arsenate type I, type II, or type III (Fed. Spec. TT-W-550)	Pounds		per cubic foot	
			<u>In. and/or In.</u>		-----Pounds per cubic foot-----										
			<u>pct of sapwood</u>												
<u>Piles (cont.)</u>															
For land or fresh water use															
Coastal Douglas-fir, western hemlock, lodgepole pine	0.75 and 85	0-1.00	17.0	17.0	17.0	0.85	--	--	--	1.00	1.00				
Southern and ponderosa pines	3.50 or 90	0-3.00	12.0	12.0	12.0	0.60	--	--	--	0.80	0.80				
Jack pine	1.50 or 85	0-2.00	12.0	12.0	12.0	0.60	--	--	--	0.80	0.80				
Red Pine	2.50 or 85	0-2.00	12.0	12.0	12.0	0.60	--	--	--	0.80	0.80				
<u>Poles (round):</u>															
Building ¹¹												C4			
Coastal Douglas-fir	2.5 or half of radius and 90	0.25-1.00	12.0	--	--	0.60	--	--	--	0.60	0.60	C23			
Southern and ponderosa pines	...do...	0.50-2.00	12.0	--	--	.60	--	--	--	0.60	0.60				
Red Pine	...do...	0.10-1.60	13.5	--	--	.68	--	--	--	0.60	0.60				
Utility												C4			
Coastal Douglas-fir	0.75 and 85	0.25-1.00 ^{12/}	9.0, 12.0	--	--	^{12/} 0.45, 0.60	0.75	0.75	--	0.60	0.60				
Southern and ponderosa pines	3.00 or 90	0.50-2.00 ^{12/}	7.5, 9.0	--	--	^{12/} .38, 0.45	0.56	0.56	--	0.60	0.60				
Red Pine	2.50 or 85	0.10-1.60 ^{12/}	10.5, 13.5	--	--	^{12/} 0.53, 0.68	0.85	0.85	--	0.60	0.60				
Jack Pine	1.50 or 85	0.10-0.75 ^{12/}	12.0, 16.0	--	--	^{12/} 0.60, 0.80	1.00	1.00	--	0.60	0.60				
Lodgepole Pine	0.75 and 85	0.10-0.75 ^{12/}	12.0, 16.0	--	--	^{12/} 0.60, 0.80	1.00	1.00	--	0.60	0.60				
Interior Douglas-fir, western larch	0.50 and 100	0.10-0.60	16.0	--	--	0.80	1.00	1.00	--	0.60	0.60				
Western redcedar	0.50 or 100	0.10-0.60	16.0	--	--	0.80	1.00	1.00	--	0.60	0.60				

Treatment of Round Wood Products (continued)

TABLE II

Form of product and service conditions	Penetration	Assay Zone	Minimum net retention of active preservative ⁹ Pentachlorophenol (Fed.Spec.TT-W-570)									Treating specifications ⁷ (AWPA C1 and others listed below)
			Coal-tar creosote (Fed.Spec.TT-C-645)	Creosote-coal tar solution (Fed.Spec.TT-C-650)	Creosote-petroleum solution (Fed.Spec.TT-W-568)	5.0 to 7.5 % solution with heavy petroleum solvent(AWPA P9 typeA)	In solution with light petroleum solvent(AWPA P9 type C)	In solution with volatile solvent (AWPA P9 type B)	Acid copper chromate (Fed.Spec.TT-W-546)	Ammoniacal copper arsenite (Fed.Spec.TT-W-549)	Chromated copper arsenate type I, type II, or type III (Fed.Spec.TT-W-550)	
	<u>In. and/or pct of sapwood</u>	<u>In.</u>	-----Pounds per cubic foot-----									
<u>Poles (cont.)</u>												
<u>Utility (cont.)</u>												
Western redcedar, Alaska yellow, and northern white cedars	0.50 or 100	0-0.5	20.0	--	--	1.00	--	--	--	--	--	C7,C8
<u>Posts (round):</u>												
<u>Building</u> ^{11/}												
Coastal Douglas-fir	2.50 or half of radius and 90	0.25-1.0	12.0	--	--	0.60	--	--	--	0.60	0.60	C23
Southern and ponderosa pines	...do...	0.50-2.0	12.0	--	--	0.60	--	--	--	0.60	0.60	
Red pine	...do...	0.10-1.6	12.0	--	--	0.60	--	--	--	0.60	0.60	
<u>Fence</u>												
Douglas-fir, western hemlock, and western larch	0.40 and 100 up to 1.00	0-1.0	6.0	6.0	7.0	0.30	0.38	0.38	0.50	0.40	0.40	C5
Southern, ponderosa, and red pines	2.00 or 85	0-1.0	6.0	6.0	7.0	0.30	0.38	0.38	0.50	0.40	0.40	
Jack Pine	1.50 or 85	0-1.0	6.0	6.0	7.0	0.30	0.38	0.38	0.50	0.40	0.40	
Lodgepole pine	1.25 or 85	0-1.0	6.0	6.0	7.0	0.30	0.38	0.38	0.50	0.40	0.40	

Treatment of Round Wood Products (continued)

TABLE II

Product and use conditions	Requirements on treatment				Other requirements	
	<u>Preservative</u>	<u>Retention</u> ^{1/}	<u>Assay zone</u>			<u>Penetration</u>
			<u>Pcf</u>	<u>In</u>		
Dual-treated marine piles	--	--	--	--	Kiln drying after first treatment not permitted.	
Coastal Douglas-fir First treatment	Ammoniacal copper arsenite or chromated copper arsenate (types I, II, or III)	1.00	0-1.00	1.0	Do.	
Second treatment	Creosote ^{5/}	20.0	0-1.00	(13/)	Do.	
Southern pine First treatment	Ammoniacal copper arsenite or chromated copper arsenate (types I, II, or III)	1.00	0-1.00	1.0	Do.	
Second treatment	Creosote ^{5/}	20.0	0-1.00	4.0 or 90	Do.	
Dual-treated lumber and timbers for marine use	--	--	--	--	Do.	
Coastal Douglas-fir First treatment	Ammoniacal copper arsenite or chromated copper arsenate (types I, II, or III)	1.50	0-0.60	0.5 and 90	Do.	
Second treatment	Creosote ^{5/}	20.0	0-0.60	0.5 and 90	Do.	
Western Hemlock First treatment	Ammoniacal copper arsenite or chromated copper arsenate (types I, II, or III)	1.50	0-0.60	0.5 and 90	Do.	
Second treatment	Creosote ^{5/}	20.0	0-0.60	0.5 and 90	Do.	
Southern pine First treatment	Ammoniacal copper arsenite or chromated copper arsenate (types I, II, or III)	1.50	0-0.60	1.0	Do.	
Second treatment	Creosote ^{5/}	20.0	0-0.60	2.5 or 85	Do.	

Treatment of Special Wood Products

TABLE III

Product and use conditions	Requirements on treatment					Other requirements
	<u>Preservative</u>	<u>Retention</u> ^{1/}		<u>Penetration</u>	<u>Assay zone</u>	
		<u>Pcf</u>	<u>In</u>			
Mine timbers	--	--	--	--	--	Mixed hardwood species commercially available are acceptable.
For structures classified as permanent	See table I, timbers in ground contact	--	--	--	--	Do.
For other structures	5 pct solution of either acid copper chromate, or fluor-chrome-arsenate-phenol mixture or 8 percent solution of chromated zinc chloride	Refusal	--	--	--	Do.
Lumber for use in contact with, or in close proximity to, foodstuffs	2.5 or 5.0 pct solubilized copper-8-quinolinolate (AWPA P8) dissolved in volatile solvent (AWPA P9)	0.25	--	--	--	Prior to treatment, lumber shall be milled to correct width and thickness, and, if practical, cut to correct length. Surface of treated wood shall be clean and free of residual solvent.
Lumber for building foundations	--	--	--	--	--	Only seasoned lumber 2 in. or less in thickness. Each charge shall be assayed.
Douglas-fir, western larch	Ammoniacal copper arsenite or chromated copper arsenate (types I, II, or III)	0.60	0-0.60	0.5 and 90		Lumber shall be incised prior to treatment.
Western hemlock	Ammoniacal copper arsenite or chromated copper arsenate (types I, II or III)	0.60	0-0.60	0.5 and 90		Do.
Southern and ponderosa pines	Ammoniacal copper arsenite or chromated copper arsenate (types I, II, or III)	0.60	0-0.60	0.7 or 90		Lumber shall contain not more than 20 pct heartwood and no boxed heart.
Plywood For use in coastal waters	Creosote ^{3/}	25.0	See 4.2.5	Each veneer penetrated		Exterior grade plywood shall be used.
	Ammoniacal copper arsenite or chromated copper arsenate (Types I, II or III)	2.50	See 4.2.5do....		

Treatment of Special Wood Products (continued)

TABLE III

Product and use conditions	Requirements on treatment			Other requirements
	<u>Preservative</u>	<u>Retention</u> ^{1/}	<u>Assay</u>	
			<u>Penetration</u>	
		<u>Pcf</u>	<u>In</u> <u>and/or</u> <u>pct of sapwood</u>	
Plywood (cont.)				
For use in building foundations				
Douglas-fir	Ammoniacal copper arsenite or chromated copper arsenate (Types I, II, or III)	0.60	See 4.2.5do....	Do.
Southern pine		0.60	See 4.2.5do....	Plywood shall contain no heartwood faces.
For use in fresh waters or in ground contact	Creosote ^{3/}	10.0	See 4.2.5do....	Exterior grade plywood shall be used.
	Pentachlorophenol in heavy solvent (AWPA P9 type A)	0.50	See 4.2.5do....	Do.
	Pentachlorophenol in light or volatile solvent (AWPA types C or B)	0.62	See 4.2.5do....	Do.
	Ammoniacal copper arsenite or chromated copper arsenate (types I, II, or III)	0.40	See 4.2.5do....	Do.
For use above ground	Creosote ^{3/}	8.0	See 4.2.5do....	Do.
	Pentachlorophenol in heavy, light, or volatile solvent (AWPA P9 types A, C, or B)	0.40	See 4.2.5do....	Do.
	Ammoniacal copper arsenite or chromated copper arsenate (types I, II or III), acid copper chromate or fluor-chrome-arsenate-phenol mixture	0.25	See 4.2.5do....	Do.
	Chromated zinc chloride	0.45	See 4.2.5do....	Do.
	Tributyltin oxide	0.06	See 4.2.5do....	Do.

Treatment of Special Wood Products (continued)

TABLE III

Footnotes for Tables I, II, and III

¹Whenever a method for the determination of retention in a treated product by the assay of a sample is described in an AWPA specification, purchase shall be made on that basis and a retention gage shall not be accepted in competitive bids.

²These standards cover treatment of species most commonly treated. For species offered and not covered by existing standards; the supplier shall furnish evidence of satisfactory experience. Penetration requirements for most generally available products are covered in AWA specifications and footnotes below. When penetration is not otherwise specified herein or in AWPA specifications, the penetration in the sapwood shall be not less than 2.5 inches unless 85 percent of the sapwood depth is penetrated (see footnote 11). For wood species not included herein or in AWPA specifications, the penetration of heartwood faces shall be not less than 0.4 inch in lumber (i.e., sawn material less than 5 in. in thickness) and not less than 0.5 inch in timbers (i.e., sawn material 5 in. or more in thickness). Retention shall be consistent with end use of the product.

³Conforming to class 3 of TT-C-645.

⁴Conforming to class 5 of TT-C-650.

⁵Conforming to either class 1, 2, or 3 of TT-C-645.

⁶Conforming to either class 1, 2, 3, 4, or 5 of TT-C-650.

⁷For ground contact use: For members more than 75 square inches in cross section at the groundline, every member shall be bored for penetration. For members 75 square inches or less in cross section at the groundline, 20 members per charge shall be bored for penetration. Should the charge contain less than 20 members, each member shall be bored. When inspecting southern yellow pine laminated timbers for penetration, borings shall be taken from two different laminations from each member. When boring Coastal Douglas-fir or western hemlock laminated timbers for penetration, one boring shall be taken from the edge of the two face laminations and one boring from each of two different interior laminations in each member.

If any boring taken from any member fails to meet the penetration requirement, that member shall be rejected. If 90 percent or more of the members bored meet the specified requirements for either size category, the charge shall be considered to meet penetration requirements. If less than 90 percent of the members bored meet the specified requirements for either size category, the charge shall be rejected.

⁸For above ground use. One boring shall be taken from each of 20 members in a charge. If 80 percent or more of the borings show a penetration of 2.5 inches or 85 percent of the sapwood in southern and ponderosa pine or 0.50 inch in the heartwood of coastal Douglas-fir or western hemlock, the charge shall be considered to meet penetration requirements. Should a charge contain less than 20 members, each member shall be bored and any member shall be rejected if it fails to meet the penetration described in the foregoing.

⁹For the assay of glued-laminated timbers, 20 borings shall be taken from the 0- to 3.0 inch zone in southern pine and 0 to 0.60 inch in coastal Douglas-fir or western hemlock.

¹⁰When reserve treated stock is assayed or when inspection is made at destination, a sample of the preservative shall be obtained from a randomly selected piling by the procedure given in AWP Standard A8. The properties of the recovered oil shall meet the following requirements when tested by AWP Standard A1:

	Creosote		Creosote-tar solution	
	Classes	Class	Classes	Class
	1 and 2	3	1, 2, 3, 4	5
Percent distilling to:				
270 degrees C minimum	15	15	15	15
355 degrees C minimum	75	70	65	65
Specific gravity of fraction at 38 c/15.5 C:				
235 to 315 degrees C minimum	1.025	1.030	1.025	1.030
315 to 355 degrees C minimum	1.095	1.105	1.095	1.105
Residue above 355 degrees C	-----	1.160	-----	1.160

¹¹In round building poles or in round posts used in post-and-beam types of foundations, penetration in each piece 10 inches or less in diameter shall be at least one-half of the radius. In each piece more than 10 inches in diameter, penetration shall be at least 2.5 inches. In all cases, 90 percent of the sapwood shall be penetrated

Mechanical means to obtain the required penetration, such as incising or boring are permitted. Borings to determine penetration shall be taken from the incised area. Borings for assay shall be taken from the approximate midpoint, but not from the incised area.

¹²The higher retention is required for large poles (Group B, 37.5 in. and over in circumference), for all poles used under severe service conditions and for all poles having a high replacement cost.

¹³1.0 inch and 85 percent if sapwood is 2.0 inches or less; 1.75 inches if sapwood is more than 2 inches.

MILITARY INTERESTS:

Preparing activity

Custodians:

AGR-AFS

Army ME
 Navy SH
 Air Force -84

User activity:

Army-AT

Review Activities:

BIBLIOGRAPHY

- Agi, Jerry J. 1983. *Structural Evaluation of Marine Structures*. Proceedings of the Specialty Conference on Port Modernization Upgrading and Repairs. ASCE/New Orleans, LA. March 21-23, 1983. pp. 662-677.
- American Wood Preservers' Association Standards*. 1986. American Wood Preservers' Association, Box 849, Stevensville, MD. 21666.
- Annual Book of ASTM Standards*. Part 22 Wood; Adhesives. 1986. American Society for Testing and Materials, 1916 Race St., Philadelphia, PA, 19103.
- Baechler, R. H. and H. G. Roth. 1964. *The Double Diffusion Method of Treating Wood: A Review of Studies*. For. Prod. Jour. 14 (4) : 171-178.
- Beal, R. H. and V. K. Smith. 1971. *Relative Susceptibilities of Coptotermes Formosanus, Reticulitermes Flavipes, and Reticulitermes Virginicus to Soil Insecticides*. J. Econ. Entomol. 64 (2) : 472-75.
- Bechgaard, Carl, Lennart Borup, Joran Jermer, and Bjorn Henningsson. 1980. *Remedial Treatment of Creosoted Railway Sleepers of Redwood by Selective Application of Boric Acid*. 11th meeting of the Swedish Wood Preservation Institute, Stockholm in Raleigh, NC.
- Boyce, John Shaw. 1961. *Forest Pathology 3rd Edition*. McGraw-Hill Book Co. 572 pp.
- Chudnoff, Martin. 1984. *Tropical Timbers of the World*. Agr. Handbook No. 607. 464 pp.
- DeGroot, Rodney C. and Bruce R. Johnson. 1979. *Preservative Treatment of Wood for Farm Use*. Cooperative Extension Service, University of Wisconsin. 12 pp.
- Department of the Navy, Naval Facilities Engineering Command. 1984. *Maintenance of Wood Utility Poles*, NAVFAC Specification TS-20312. No page Numbers.
- Design Values for Wood Construction*. 1982. National Forest Products Association, 1619 Massachusetts Ave., N.W., Washington, D.C. 20036. 32 pp.
- Environmental Protection Agency, Friday, July 13, 1984. *Creosote, Pentachlorophenol, and Inorganic Arsenicals; Intent to Cancel Registrations of Pesticide Products Containing Creosote, Pentachlorophenol (including its salts) and the Inorganic Arsenicals; Determination Concluding the Rebuttable Presumption Against Registration of the Wood Preservative Uses of Pesticide Products; Availability of Position Document*. Federal Register 49(136) : 28666-28689.
- Eslyn, Wallace E. and Joe W. Clark, 1976. *Appraising Deterioration in Submerged Piling Organisms and Wood: International Symposium, Berlin-Dahlem*, 1975. Supplement 3 to Materials and Organisms. pp. 43-52.

Eslyn, Wallace E. and Joe W. Clark,
1979. *Wood Bridges--Decay Inspection
and Control*. Agr. Hbk. No. 557. 32 pp.

General Services Administration,
Washington, D.C.

- a. 1961. *Wood Preservative, Acid Cop-
per Chromate*. TT-W-546c.
- b. 1961. *Wood Preservative,
Ammoniacal Copper Arsenite*. TT-W-
549c.
- c. 1961. *Wood Preservative, Chromated
Zinc Chloride*. TT-W-551d.
- d. 1966. *Creosote, Coal-Tar Solution*.
TT-C-650d.
- e. 1966. *Creosote, Coal-Tar, Technical*.
TT-C-645b.
- f. 1967. *Wood Preservative, Fluoride-
Chromate-Arsenate-Phenol Mixture*.
TT-W-535b.
- g. 1968. *Wood Preservative, Chromated
Copper Arsenate Mixture*. TT-W-
00550E.
- h. 1968. *Wood Preservation: Treating
Practices*. TT-W-571. Revised 1974.
- i. 1969. *Wood Preservative, Water
Repellent*. TT-W-572B.

Gjovik, Lee R. and Roy H. Baechler,
1977. *Selection, Production, Procure-
ment and Use of Preservative-Treated
Wood, Supplementing Federal Specifica-
tion TT-W-571*. USDA Forest Service
General Technical Report FPL-15. 37 pp.

Grading Rules. 1977. Southern Pine In-
spection Bureau, Box 846, Pensacola, FL
32594. 214 pp.

Graham, R. D. 1973. *Preventing and
Stopping Internal Decay of Douglas-fir
Poles*. *Holzforschung* 27 (5) : 168-173.

Graham, R. D. (Undated). *Wood Preser-
vation Minicourse*. Slide-tape package.
Forestry Media Center, Oregon State
University, Corvallis.

Graham, Robert D. and Guy G. Helsing.
1979. *Wood Pole Maintenance Manual:
Inspection and Supplemental Treatment
of Douglas-fir and Western Red Cedar
Poles*. Forest Research Laboratory,
Oregon State University, Corvallis,
Oregon. 62 pp.

Hand, O. F., P. A. Lindgren, and A. F.
Wetsch. 1970. *The Control of Fungal
Decay and Insects in Transmission Poles
by Gas Phase Treatment*. Branch Lab.,
Bonneville Power Adm., Vancouver,
Wash. 28 pp.

Helsing, Guy G. 1979. *Recognizing and
Controlling Marine Wood Borers*. Publi-
cation 49. Oregon State University Ex-
tension Service.

Helsing, Guy G., Robert D. Graham and
Mark A. Newbill. 1984. *Effectiveness of
Fumigants Against Marine Wood-Borers*.
For. Prod. Jour. 34 (6) : 61-64.

Helsing, G. G., J. Morrell, and R. D.
Graham. 1984. *Evaluations of
Fumigants for Control of Internal Decay
in Pressure-Treated Douglas-fir Poles
and Piles*. *Holzforschung* 38(5) : 277-
280.

- Helsing, Guy G., Jeffrey J. Morrell and Robert D. Graham. 1986. *Service Life of Douglas-fir Piles: Methods for Protecting Cutoff Tops From Decay*. For. Prod. J. 36(2) : 21-24.
- Highley, Terry L. and Wallace E. Eslyn. 1982. *Using Fumigants to Control Interior Decay in Waterfront Timbers*. For. Prod. Jour. 32(2) : 32-34.
- Hochman, H. 1967. *Creosoted Wood in a Marine Environment: A Summary Report*. Proc., Am. Wood-Preservers'; Assoc. 63: 138-50.
- Hunt, George M. and George A. Garratt. 1967. *Wood Preservation*. 3rd ed. McGraw-Hill Book Company. 433 pp.
- Johnston, H. R., Virgil K. Smith and Raymond H. Beal. 1972. *Subterranean Termites, Their Prevention and Control in Buildings*. U.S.D.A. Home and Garden Bulletin No. 64. 30 pp.
- Keeney, C. A. and S. E. Pollio. 1984. *Evaluation of Nondestructive Underwater Timber Inspection Techniques*. Technical Note N-1703, Naval Civil Engineering Laboratory, Port Hueneme, CA 58 pp.
- Koch, Peter. 1972. *Utilization of the Southern Pines*. Vol. I and II. Agr. Handbook No. 420. USDA. 1663 pp.
- Kollman, Franz F. P. and Wilfred A. Cote, Jr. 1968. *Principles of Wood Science and Technology Vol I Solid Wood*. Springer-Verlag. 592 pp.
- Levy, Michael P. No Date. *A Guide to the Inspection of Existing Homes for Wood-Inhabiting Fungi and Insects*. U.S. Dept. of Housing and Urban Development, Office of Policy Development and Research. 104 pp.
- MacLean, J. D. 1935. *Manual of Preservative Treatment of Wood by Pressure*. USDA Misc. Publ. No. 224.
- Marine Biology Operational Handbook*. Nav. Docks MO-311. 1965. U.S. Dept of the Navy, Washington, D.C.
- Meyer, Robert M. and Robert M. Kellogg. ed. 1982. *Structural Use of Wood in Adverse Environments*. Van Norstrand Reinhold Co. 510 pp.
- Miller, Regis B., J. Thomas Quirk and Donna J. Christensen. 1985. "Identifying White Oak Logs with Sodium Nitrite," *For. Prod. Jour.* 35(2) : 33-38.
- Moore, Harry B. 1979. *Wood-inhabiting Insects in Houses: Their Identification, Biology, Prevention and Control*. U.S. Dept. of Agr. Forest Service, and Dept. of Housing and Urban Development. 133 pp.
- Morrell, Jeffrey, Guy G. Helsing and Robert D. Graham, 1984. *Marine Wood Maintenance Manual: A Guide for Proper Use of Douglas-fir in Marine Exposure*. Res. Bull. 48 Forest Research laboratory. Oregon State Univ. 62 pp.

Morrell, Jeffrey J. and Malcolm E. Cor-
den. 1986. *Controlling Wood Deteriora-
tion With Fumigants: A Review*. For.
Prod. Jour. 36(20) : 26-34.

National Woodwork Manufacturers As-
sociation, 1981A. *NWMA Industry
Standard for Water-Repellent Preserv-
ative Treatment for Millwork I.S.4-81*.
National Woodwork Manufacturers As-
sociation, 205 West Touhy Avenue, Park
Ridge, Illinois 60068. 6 pp.

Nicholas, Darrel D. ed. 1973. *Wood
Deterioration and Its Prevention by Pre-
servative Treatment Vol. I and II*,
Syracuse University Press. 380 and 402
pages.

Pallets and Palletization. 1968. Nation-
al Wooden Pallet and Container Associa-
tion, 1619 Massachusetts Ave. N.W.,
Washington, D.C. 20036. 19 pp.

Panshin, A. J. and Carl De Zeeuw. 1980.
Textbook of Wood Technology. 4th Ed.
McGraw-Hill Book Company, New
York, New York. 722 pp.

REA. 1974. *Pole Inspection and Main-
tenance*. U.S. Dep. Agri., Rural
Electrification Admin., Washington, D.C.
Bull. 161-4. 50 p.

Richards, B. R. 1977. *Marine Borers
and Fungi in Wood in Marine Structures*.
Proceedings of a Seminar. UNC Sea
Grant Pub. UNC-SG-77-12. Ed. by
Michael Levi and Jerry Machemehl. pp.
18-22.

Roe, T. 1984. *Maintenance of
Waterfront Structures*. P. 38-40 in
*Marine Biodeterioration: An Interdis-
ciplinary Study*. (J.D. Costlow and R.C.
Tipper, eds.) Naval Institute Press, An-
napolis, Md.

Scheffer, Theo. C., C. G. Duncan and
Thomas Wilkinson. 1969. *Condition of
Pine Piling Submerged 62 years in River
Water*. Wood Preserving 47(1) : 22-24.

Shigo, A. L. 1980. *Decay, Decayed
Wood, and the Shigometer*. The Interna-
tional Research Group on Wood Preserva-
tion. Document No: IRG/wp/281. IRG,
Stockholm, Sweden. 2 p.

Shigo, Alex L., Walter C. Shortle, and
Julian Ochrymowych, 1977. *Detection of
Active Decay at Groudline in Utility
Poles*. Forest Service General Technical
Rept. NE-35. 26 pp.

Shortle, W. C. 1982. *Decaying Douglas-
fir Wood: Ionization Associated with
Resistance to a Pulsed Electric Current*.
Wood Sci. 15:29-32.

Shortle, W. C., A. L. Shigo and J.
Ochrymowych. 1978. *Patterns of Resis-
tance to a Pulsed Electric Current in
Sound and Decayed Utility Poles*.

Smith, Susan M. and Jeffrey J. Morrell.
1986. *Correcting Pilodyn Measurement
of Douglas-fir for Different Moisture
Levels*. For. Prod. Jour. 36(1):45-46.

Southern Forest Products Association. No date. *Pressure Treated Southern Pine*. Southern Forest Products Association, Box 52468, New Orleans, LA 70152. 10 pp.

Specifications and Dimensions for Wood Poles. ANSI 05.1-1979. American National Standards Institute, 1430 Broadway, New York, New York 10018. 20 pp.

Steiger, F., and G. Horeczko. 1982. *The Protection of Timber Piling from Marine Borer Attack by Application of Plastic Barriers*. International Journal of Wood Preservation 2(3) :127-129.

The Manual of Recommended Practice for Railway Engineering and Maintenance of Right-a-Way. Chapter 3, Ties and Wood Preservation. 1986-87. American Railway Engineering Association, 50F Street, N.W. Suite 7702, Washington, D.C. 20001.

U.S. Dept. of Agr. and the U.S. Environmental Protection Agency (no date). *Apply Pesticides Correctly--A Guide for Private and Commercial Applicators*. Extension Service, U.S. Dept. of Agr. 128 pp.

Wakeman, C. M., and L. L. Whiteneck. 1960. *Extending Service Life of Wood Piles in Seawater*. P. 36-50 in ASTM Special Technical Publication No. 275, Treated Wood in Marine Use. American Society for Testing and Materials, Philadelphia, Pennsylvania.

Western Wood Preservers Institute. No date. *Guide to the Characteristics, Use and Specifications of Pressure-Treated Wood*. Western Wood Preservers Institute, 5830 Oberlin Dr., Suite 300, San Diego, CA 92121. 8 pp.

Wilson, James B. 1981. *Pole Inspection Using the Pilodyn*. In Proceedings of the 7th Wood Pole Institute, Dept. of Forestry and Wood Science, Colorado State University, Fort Collins, CO

Wood: Colors and Kinds. 1956. Forest Products Laboratory, Forest Service. Agr. Handbook 101. 36 pp.

Wood Handbook: Wood as an Engineering Material. 1974. Agr. Handbook No. 72. Forest Products Laboratory, Madison, WI

Wood Preservation Applicators Manual, no date. A manual developed in cooperation with American Wood Preservers Institute, Environmental Protection Agency, Department of Agriculture (Idaho, Oregon and Washington); Society of American Wood Preservers, State University of (Idaho, Oregon and Washington), Washington State Department of Ecology, Western Wood Products Association, and Western Wood Preservers Institute. No. page numbers.

Index

A

Abnormal Wood, 2-28
ACA, 5-8, 5-18
ACC, 5-8
Acid Copper Chromate, 5-8
ACZA, 5-8, 5-18
Ambrosia Beetles, 4-42, 4-44
Ammonical Copper Arsenate, 5-8
Ammonical Copper Zinc Arsenate, 5-8
Annual Rings, 2-3
Anobiids, 4-34
Ants, 4-30, 7-4
Armed Forces Pest Mgmt Board, 5-18
Ash, 2-14

B

Bacteria, 4-1
Bandage Treatment, 7-12
Bankia, 4-53
Bark Beetles, 4-41
Barriers, 7-21
Bees, Carpenter, 4-48
Beetles (See Powder Post Beetles), 4-33
Biological Tests, 7-10
Bis (Tri-N-Butyltin) Oxide, 5-8
Black Gum, 3-4, 3-9
Blue Stain, 4-7
Borers (See Marine), 4-50
Boring, 7-6
Bostrichids, 4-36
Boultonizing, 5-4
Bound Water, 2-20
Brashness, 4-10
Brown Pocket Rot, 4-15
Brown Rots, 4-10
Brush Treatments, 5-1
Buprestids, 4-41

C

Care of Treated Wood, 5-9
Carpenter Ants, 4-30, 7-4
Carpenter Bees, 4-48
CCA, 5-8, 5-18
Celcure[®], 5-8
Cell Types, 2-10
 Parenchyma, 2-10
 Pores, 2-10
 Tracheids, 2-10
 Vessels, 2-10
Cellulose, 2-14
Cerambycids, 4-36
Certificates of Conformance, 6-12
Chemical Stain, 4-7
Chemonite[®], 5-8
Chromated Copper Arsenate, 5-8
Chromated Zinc Chloride, 5-8
Clams, Rock Burrowing, 4-55
Coal Tar Creosote, 5-7
Compression Failure, 2-31
Compression Strength, 2-24
Compression Wood, 2-28
Consumer Information Sheets, 5-18
Control of Powder Post Beetles, 4-44
Copper Naphthenate, 5-8
Copper-8-Quinolinolate, 5-8
Creosote, 5-7
Cross Break, 2-32
Crossties, 7-24
Crustacea, 4-55
Culturing, 7-10
Curculionids, 4-41

D

Dampwood Termites, 4-30
Debarking, 5-2
Decay, 4-10, 7-1, 7-4, 7-15, 7-22
 Internal, 7-1
 Surface, 7-1

Density, 2-16
Deterioration, 4-1
Diffuse Porous, 2-5
Diffusion, 5-7
Dip Treatment, 5-1
Douglas-Fir, 3-1, 3-3, 3-5
Dry Rot, 4-10
Drying, 2-23, 5-2
Drywood Termites, 4-28
Durability, 2-14

E

Earlywood, 2-3
Edge Grain, 2-5
Empty Cell Process, 5-4
End Grain, 2-5
Engraver Beetles, 4-41
Environmental Concerns, 5-18
Environmental Protection Agency, 5-18
Equilibrium Moisture Content, 2-20
Extractives, 2-14

F

False Powder Post Beetles, 4-36
Fiber Saturation Point, 2-20
Fibers, 2-10
Fir
 Douglas, 3-1, 3-3, 3-5
 White, 3-1, 3-3, 3-6
First Aid, 5-24
Flat Sawn, 2-8
Flat-Headed Wood Borers, 4-41
Formosan Termites, 4-23
Full Cell Process, 5-4
Fumigation, 7-13, 7-14
Fungi, 4-1
Furniture Beetles, 4-34

G

Grain, 2-5
 Edge, 2-5

End, 2-5
Interlocked, 2-8
Spiral, 2-31
Greensalt, 5-8
Gribbles, 4-55
Ground Line Treatment, 7-12
Growth Increments, 2-3
Growth Rate, 2-3
Gum
 Black, 3-4, 3-9
 Sweet, 3-4, 3-8
 Tupelo, 3-9

H

Handling of Treated Wood, 5-9
Hardwoods, 2-1, 2-10
Heartwood, 2-8
Hemicellulose, 2-14
Hemlock, 3-3
Hot and Cold Bath, 5-7
Hyphae, 4-1

I

Incising, 5-4
Insects, 4-19
Inspection, 6-6, 7-4, 7-15, 7-22, 7-24
Interlocked Grain, 2-8
Internal Decay, 7-1

J

Juvenile Wood, 2-28

K

K-33,5-8
Kick Holes, 4-28, 4-29
Knots, 2-31

L

Latewood, 2-3
Lignin, 2-14
Limnoria, 4-55
Long-horned Beetles, 4-40
Lyctids, 4-34
Lumber, 6-2, 6-3, 6-17

M

Machining, 5-4
Marine Borers, 4-50, 7-15, 7-18
 Bankia, 4-53
 Clams, Rock Burrowing, 4-55
 Crustacea, 4-55
 Gribbles, 4-55
 Limnoria, 4-55
 Martesia, 4-55
 Pholads, 4-55
 Rock Borers, 4-55
 Shipworms, 4-53
 Sphaeroma, 4-56
 Teredinids, 4-53
 Teredo, 4-53
Martesia, 4-55
Material Specifications, 6-1
Mechanical Properties, 2-23
 Compression Strength, 2-24
 Modulus of Elasticity (MOE), 2-24
 Modulus of Rupture (MOR), 2-24
 Shear Strength, 2-24
 Side Hardness, 2-24
 Tensile Strength, 2-24
 Toughness, 2-24
Metallic Beetles, 4-41
Miscellaneous Yellow Pines, 3-7
Modulus of Elasticity (MOE), 2-24
Modulus of Rupture (MOR), 2-24
Moisture Content, 2-16
Moisture Content (Minimum for Decay), 4-7
Moisture Meter, 7-8
Molds, 4-7

Mollusca, 4-53

N

National Wood Window and Door Assn, 5-1
Native Subterranean Termites, 4-19
Navy Policy, 6-7

O

Oak
 Red, 3-1, 3-4, 3-7
 White, 3-1, 3-4, 3-8
Old House Borer, 4-40
Organic Preservatives, 5-7
Oxidation Stain, 4-7

P

Panels, Structural Use, 6-2
Parenchyma, 2-10
Penetration, 5-2
Pentachlorophenol, 5-7
Permeability, 2-16
Pholads, 4-55
Pick, 7-8
Pick Test, 4-10, 7-8
Piles, 6-2, 6-3, 7-15
Pilodyn, 7-8
Pine
 Miscellaneous Yellow, 3-7
 Southern Yellow, 3-1, 3-3, 3-7
Pits, 2-14
Plain Sawn, 2-8
Plywood, 6-3, 6-17
Pocket Rot, 4-15
Poisoning, 5-24
Pol-tek, 7-10
Poles, 6-2, 6-3, 7-1
Pores, 2-5, 2-10
Powder Post Beetles, 4-33
 Ambrosia, 4-42, 4-44
 Anobiids, 4-34

- Bark Beetles, 4-41
 Bostrichids, 4-36
 Buprestids, 4-41
 Cerambycids, 4-36
 Control, 4-44
 Curculionids, 4-41
 Engraver Beetles, 4-41
 Flat-Headed Wood Borers, 4-40
 Long-horned Beetles, 4-36
 Lyctids, 4-34
 Metallic Beetles, 4-41
 Old House Borer, 4-40
 Prevention, 4-44
 Round-headed Wood Borers, 4-40
 Scolytids, 4-41
 Snout Beetles, 4-41
 Weevil, Wood Boring, 4-41
 Preservatives, 5-7
 ACA, 5-8
 ACC, 5-8
 Acid Copper Chromate, 5-8
 ACZA, 5-8
 Ammonical Copper Arsenate, 5-8
 Ammonical Copper Zinc Arsenate, 5-8
 Bis (Tri-N-Butyltin) Oxide, 5-8
 CCA, 5-8
 Celcure[®], 5-8
 Chemonite[®], 5-8
 Chromated Copper Arsenate, 5-8
 Coat Tar Creosote, 5-7
 Copper Naphthenate, 5-8
 Copper-8-Quinolinolate, 5-8
 Creosote, 5-7
 Greensalt, 5-8
 K-33, 5-8
 Pentachlorophenol, 5-7
 TBTO, 5-8
 Wolman, 5-8
 Zinc Naphthenate, 5-8
 Pressure Treatment, 5-4
 Prevention of Powder Post Beetles, 4-44
- Q**
- Quartered Lumber, 2-5
- R**
- Radial Surface, 2-5
 Railroad Ties, 6-2, 6-3, 6-17
 Reaction Wood, 2-28
 Red Oak, 3-1, 3-4, 3-7
 Reinforcement, 7-15
 Remedial Treatment, 7-22, 7-24
 Resin Canal, 2-11
 Retention, 5-2
 Reuping and Lowry Process, 5-7
 Ring Porous, 2-5
 Rock Boring Piddock, 4-50
 Rots, 4-10
 Brown, 4-10
 Brown Pocket, 4-15
 Pocket, 4-15
 Soft, 4-15
 White, 4-10
 White Pocket, 4-15
 Round-headed Wood Borer, 4-40
- S**
- Safety, 5-18
 Sapstains, 4-7
 Sapwood, 2-8
 Scolytids, 4-41
 Scraping, 7-8
 Semi-Ring Porous, 2-5
 Serviceability, 7-12, 7-20
 Shake, 2-31
 Shear Strength, 2-24
 Shell Thickness Indicator, 7-10
 Shelling, 2-28
 Shelter Tubes, 4-19
 Shigometer, 7-8
 Shipworms, 4-50, 4-53, 7-18
 Shrinking, 2-20
 Side Hardness, 2-24

Softwoods, 2-1, 2-10
 Sonic Probe, 7-20
 Sonic Testing, 7-18
 Sounding, 7-6
 Southern Yellow Pine, 3-1, 3-3, 3-7
 Species Groups, 2-1, 2-3
 Species Separation, 3-1
 Specific Gravity, 2-16
 Sphaeroma, 4-56
 SPIB Quality Mark, 6-19
 Spike Kill, 7-24
 Spiral Grain, 2-31
 Split, 2-31
 Spores, 4-1
 Spray Treatments, 5-1
 Stains, 4-7
 Blue, 4-7
 Chemical, 4-7
 Oxidation, 4-7
 Sap, 4-7
 Steam Conditioning, 5-4
 Storage of Treated Wood, 5-9
 Strength Properties, 2-23
 Stubbing, 7-15
 Subterranean Termites, 4-19
 Formosan, 4-23
 Native, 4-19
 Superficial Treatments, 5-1
 Surface Decay, 7-1
 Swamp Tupelo, 3-9
 Swarms, 4-23
 Sweet Gum, 3-4, 3-8
 Swelling, 2-20

T

Tangential Surface, 2-8
 TBTO, 5-8
 Tensile Strength, 2-24
 Tension Wood, 2-28
 Teredinids, 4-53
 Teredo, 4-53
 Termites, 4-19, 7-4
 Dampwood, 4-30

Drywood, 4-28
 Formosan, 4-23
 Subterranean, 4-19
 Texture, 2-3
 Timbers, 6-2, 6-3, 6-17
 Tracheids, 2-10
 Treatability, 2-16
 Tupelo Gum, 3-9

V

Vacuum Treatments, 5-2
 Vapor Drying, 5-4
 Vertebrate Organisms, 7-4
 Vessels, 2-10
 Void Treatment, 7-13

W

Water Borne Preservatives, 5-8
 Water Tupelo, 3-9
 Water-Repellent Preservatives, 5-1
 Weathering, 2-23
 Weevil, Wood Boring, 4-41
 Western Hemlock, 3-3
 White Fir, 3-3, 3-6
 White Oak, 3-4, 3-8
 White Pocket Rot, 4-15
 White Rots, 4-10
 Wolman, 5-8
 Wood Decay, 4-10
 Wood Drying, 2-23

Z

Zinc Naphthenate, 5-8